

- IT** MONTAGGIO SYNTESIS® LINE
CARTONGESSO SP.100
- GB** ASSEMBLY AND INSTALLATION
SINGLE SYNTESIS® LINE, 100 mm
PLASTERBOARD WALL
- PT** MONTAGEM SYNTESIS® LINE PARA DE
GESSO CARTONADO ESP.100
- CZ** MONTÁŽ MODELU SYNTESIS® LINE
SÁDROKARTON TL.100
- SK** MONTÁŽ MODELU SYNTESIS® LINE DO
SADROKARTÓNU HR.100 mm
- ES** MONTAJE SYNTESIS® LINE
CARTÓN-YESO ESP.100
- NL** MONTAGE SYNTESIS® LINE
GIPSKARTON DIKTE 100
- FR** NOTICE DE MONTAGE DU KIT SYNTESIS®
LINE UNIQUE ÉPR.100 VERSION PLAQUE
DE PLÂTRE
- DE** MONTAGEANLEITUNG FÜR SYNTESIS® LINE
GIPSKARTON 100 mm FERTIGE
WANDSTÄRKE
- PL** MONTAŻ KASETY SYNTESIS® LINE O
GR.100 mm POD ZABUDOWĘ
GIPSOWO-KARTONOWĄ
- RU** МОНТАЖ ECLISSE SYNTESIS® LINE
ГИПСОКАРТОН ТОЛЩ. 100
- RO** MONTAJ ECLISSE SYNTESIS® LINE GIPS
CARTON GROS. PERETE 100 mm
- SI** MONTAŽA ECLISSE SYNTESIS® LINE Z
MAVČNO PLOŠČO deb.100 mm
- HU** ECLISSE SYNTESIS® LINE 100-AS
TOLÓAJTÓ SZERELÉSE GIPSZKARTON
FALHOZ
- HR** MONTAŽA ECLISSE SYNTESIS® LINE
GIPS PLOČA DEBLJINA 100 mm
- FI** KASAUS- JA ASENNUSOHJE SYNTESIS® LINE
SINGLE, VALMIS SEINÄPAKSUUS 100 mm,
LEVYRAKENTEINEN SEINÄ
- TR** SYNTESIS® LINE ALÇIPANEL
MODELI MONTAJI SP.100

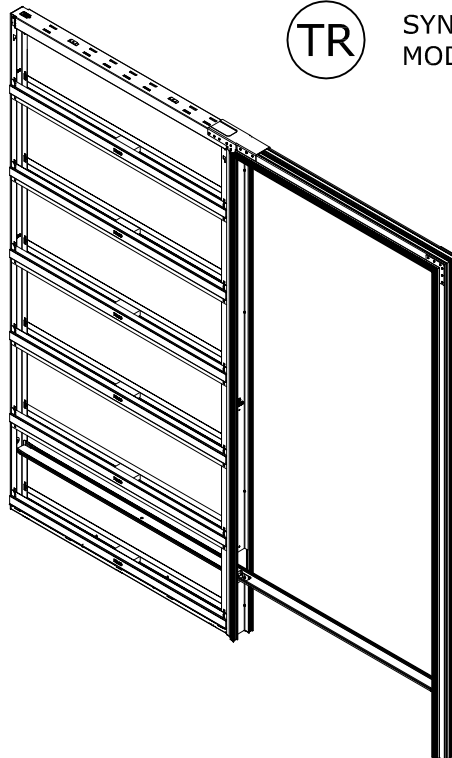



IT

Seguire attentamente le istruzioni.
Per un corretto montaggio, utilizzare utensili adatti come indicato e, per una corretta ergonomia, eseguire gli assemblaggi su supporti adeguati.
Alcune parti dei componenti possono avere delle superfici appuntite.
E' necessario quindi utilizzare adeguati dispositivi di protezione e proteggere le zone di lavoro.
"ECLISSE srl", non si assume alcuna responsabilità per danni derivati dall'uso non conforme alle presenti istruzioni.

Tutti i componenti del controtelaio sono testati e controllati in "ECLISSE srl"

GB

If you follow carefully these instructions for the assembly and installation process your life will be easier!
A pair of tressles are very useful when assembling the frames.
Some parts may have sharp edges so use gloves and be careful when handling the parts.

All Eclisse products are fully inspected and tested before they leave the factory.

PT

Seguir atentamente as instruções.
Para uma instalação adequada, utilize ferramentas adequadas conforme as instruções e ergonomia adequada, execute as ligações de apoio apropriados.
Algumas partes dos componentes podem ter superfícies cortantes.
Por conseguinte, é necessário o uso de equipamentos de protecção adequado e proteger as zonas de trabalho.
"ECLIPSE srl", não assume qualquer responsabilidade por danos resultantes da utilização não de acordo com estas instruções.

Todos os componentes do caixilho são testados e controlados na "Eclisse srl"

CZ

Postupujte pozorně dle pokynů.
Pro správnou instalaci používejte vhodné nástroje a s ohledem na bezpečnost práce používejte vhodné pracovní pomůcky. Některé vyrobené části mohou obsahovat ostré prvky. Proto je nutné používat odpovídající ochranné pomůcky a chránit pracovní místa. "ECLISSE srl" neodpovídá za žádné škody vyplývající z nedodržení návodu na montáž.

Všechny komponenty stavební zárubně jsou testovány a kontrolovány v "ECLISSE srl".

SK

Dôsledne dodržiavajte návod na montáž.
Pri montáži používajte uvedené náradie.
Kvôli správnej ergonomii a bezpečnosti pri práci odporúčame použiť montážne podpery.
Niektoré diely môžu mať ostré hrany.
Používajte ochranné pracovné prostriedky.
„ECLISSE srl.“ nezodpovedá za škody spôsobené nedodržaním návodu na montáž.

Všetky komponenty puzdra sú testované a kontrolované v „ECLISSE srl.“.

ES

Seguir las instrucciones con atención.
Para un montaje correcto, utilizar las herramientas indicadas, y para una correcta funcionalidad, ensamblar en los soportes adecuados.
Algunas partes del producto pueden contener superficies punzantes y/o cortantes.
Se necesita utilizar dispositivos de protección adecuados y proteger los espacios de trabajo.
"Eclisse SRL" no asume responsabilidad alguna por los daños derivados en la utilización no conforme a estas instrucciones.

Todos los componentes del contramarco están testados y controlados en "ECLISSE SRL".

NL

Volgt u deze instructies nauwkeurig.
Gebruik voor een correcte montage geschikt gereedschap, zoals aangeraden.
Voor een correcte werkhouding adviseren wij met schragen te werken.
Sommige delen van de verschillende onderdelen kunnen scherpe kanten hebben, daarom is het noodzakelijk om de juiste bescherming te dragen en de werkruiimte te beschermen.
"ECLISSE srl" is niet aansprakelijk voor schade die ontstaat is door het niet opvolgen van deze instructies.

Alle delen van het frame zijn volledig geïnspecteerd en getest door "ECLISSE srl".

FR

Suivre scrupuleusement les instructions
Afin de réaliser un assemblage correct, choisir un support adapté et utiliser les outils appropriés comme indiqué sur la notice.
Quelques éléments du produit peuvent avoir des parties pointues ou coupantes, il est donc nécessaire d'utiliser des protections corporelles efficaces et sécuriser l'espace de montage.
ECLISSE décline toute responsabilité pour tous dommages provoqués par le non respect de ces règles.

Tous les composants du produit sont testés et vérifiés par ECLISSE SRL.

DE

Folgen Sie genau der Montageanleitung
Für die korrekte Montage, verwenden Sie die angegebenen passenden Werkzeuge. Für die korrekte Ergonomie, sollten die Montagearbeiten auf passende Arbeitsflächen ausgeführt werden.
Einige der Bauteile können spitze Oberflächen haben. Es ist notwendig passende Schutzvorrichtungen zu verwenden und die Arbeitsfläche schützen.
„Eclisse Srl“ übernimmt keine Verantwortung für Beschädigungen, die durch Nichtbeachtung der Montageanleitung hervorgerufen werden.
Wandöffnung nach DIN 18183-1 erstellen
Alle Bauteile des Einbaukastens wurden in „Eclisse“ geprüft und getestet.

PL

Postępować zgodnie z instrukcją montażu.
W celu wykonania prawidłowego montażu, używać odpowiednich narzędzi, zgodnych ze wskazaniami, a dla zapewnienia odpowiedniej ergonomii pracy przy dokonaniu montażu stosować odpowiednie podpory. Powierzchnia niektórych elementów składowych może być ostra. W związku z tym koniecznym jest stosowanie odpowiednich środków ochrony indywidualnej oraz zabezpieczenie obszaru pracy. Eclisse SRL uchyła się od poniesienia jakiegokolwiek odpowiedzialności za poniesione szkody wynikające z postępowania niezgodnego z niniejszą instrukcją.

Wszelkie części składowe asortymentu Eclisse SRL są testowane w wewnętrznym laboratorium.

RU

Пожалуйста, строго следуйте инструкциям.
Для правильной установки пользоваться соответствующим оборудованием как указано, для правильной эргономики сделать монтаж на надежных основах. Некоторые части могут иметь заостренные концы, в связи с чем следует использоваться соответствующим предохранительным устройством и защитить рабочую зону.
«ECLISSE srl» не несет ответственности за ущерб, ставший следствием несоблюдения правил, содержащихся в данной инструкции.

Все компоненты пенала проходят необходимую проверку в фирме «"ECLISSE srl"».

RO

Urmați cu atenție instrucțiunile de montaj.
Pentru un montaj corect, folosiți ustensile potrivite, iar pentru o ergonomie adecvată, asamblarea se face pe suporturi corespunzătoare, urmând metodele indicate. Unele părți ale componentelor pot avea suprafețe ascuțite.
Prin urmare, este necesar să se folosească echipamente de protecție și să se asigure zona de lucru.
ECLISSE EST SRL nu își asumă nici o responsabilitate pentru daunele survenite ca rezultat al nerespectării prezentelor instrucțiuni.

Toate componentele din structura cadrului metalic sunt testate și controlate în fabrică.

SI

Če boste pazljivo prebrali in upoštevali dana navodila za sestavo in montažo podboja bo bistveno enostavneje.
Priporočljiva je uporaba rokavic zaradi morebitnih ostrih robov in previdno rokujte z izdelkom.

Vsi Eclisse izdelki so pod stalno kontrolo in testirani preden zapustijo tovarno.

HU

Az összeszerelésnél figyelmesen kövesse a beépítési útmutatót!
Szerelőbak használata megkönnyíti az összeszerelést.
Az éles szélek sérülést okozhatnak, ezért használjon védőkesztyűt az összeszerelésnél.

Minden Eclisse termék minőségellenőrzésen esik át forgalomba kerülés előtt.

HR

Pažljivo slijedite upute.
Za pravilnu montažu, koristite odgovarajući alat kao što je navedeno, a za postizanje pravilnog ergonomskog položaja, montirajte dijelove na odgovarajuće nosače. Površine pojedinih sastavnih dijelova mogu biti zaostrene. Stoga je potrebno koristiti odgovarajuću zaštitnu opremu i zaštititi područja rada.
"ECLISSE srl" ne preuzima nikakvu odgovornost za štete prouzročene korištenjem koje nije u skladu s ovim uputama.

Svi sastavni dijelovi okova za vrata su ispitani i provjereni u "ECLISSE srl"

FI

Noudata näitä kokoamis- ja asennusohjeita tarkasti.
Kehysten kokoamisessa kannattaa käyttää apuna pukkeja.
Käytä suojakäsineitä, sillä osien reunat voivat olla teräviä.

Kaikki Eclisse-tuotteet tarkastetaan ja testataan tehtaalla ennen toimittamista.

TR

Eğer bu talimatları dikkatle takip ederseniz, montaj ve kurulum için işiniz daha kolay olacaktır.
Çerçevenin montajını yaparken, bir çift kasanın kullanılması çok faydalı olur.
Bazı parçalar keskin kenarlara sahip olabilir, bu nedenle eldiven kullanılmalı ve parçaları tutarken daha dikkatli olunmalıdır.

Eclisse'nin tüm ürünleri fabrika çıkışından önce kontrol edildi ve test edildi.

ATTREZZATURA NECESSARIA PER IL MONTAGGIO
TOOLS REQUIRED
EQUIPAMENTOS NECESSÁRIOS PARA A MONTAGEM
NÁRADÍ POTŘEBNÉ K MONTÁŽI
NÁRADIE POTREBNÉ NA MONTÁŽ
HERRAMIENTAS NECESARIAS PARA EL MONTAJE
BENODIGD GEREEDSCHAP
OUTILS NECESSAIRES POUR L'ASSEMBLAGE
NOTWENDIGES WERKZEUG ZUR AUSFÜHRUNG DER MONTAGE
OPRZYRZĄDOWANIE POTRZEBNE DO MONTAŻU
НОЕОБХОДИМОЕ ДЛЯ УСТАНОВКИ ОБОРУДОВАНИЕ
ECHIPAMENTE NECESARE PENTRU MONTAJ
PRIPOROČLJIVO ORODJE
SZÜKSÉGES ESZKÖZÖK
ALAT POTREBAN ZA MONTAŽU
TARVITTAVAT VÄLINEET
GEREKLİ ARAÇLAR

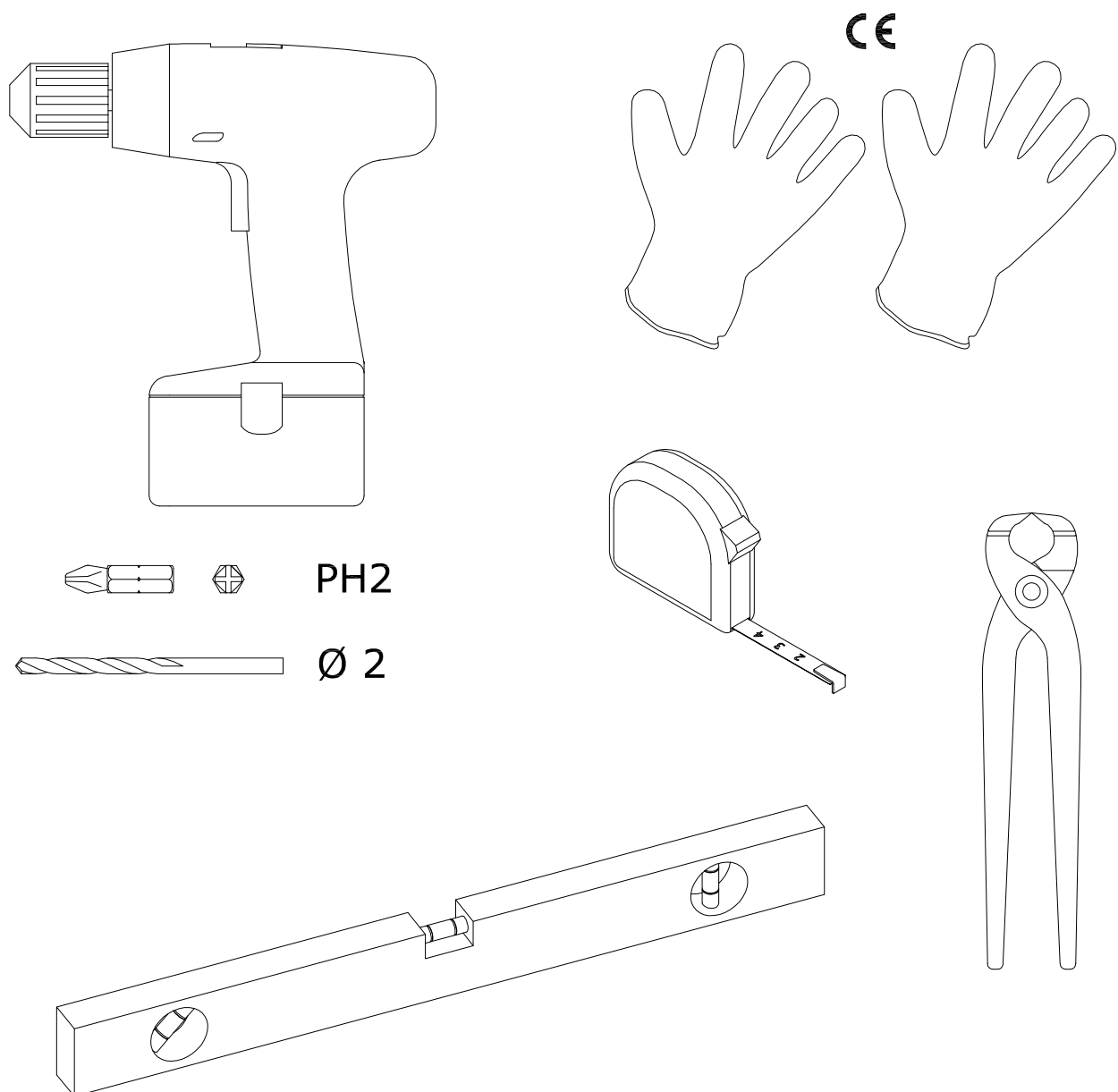

COMPONENTI / COMPONENTS / COMPONENTES / KOMPONENTY / KOMPONENTY /
 COMPONENTES / ONDERDELEN / COMPOSANTS / BAUTEILE / CZ ĘŚCI / КОМПОНЕНТЫ /
 COMPONENTE / SESTAVNI DELI / ALKATRÉSZEK / SASTAVNI DIJELOVI / OSAT / BİLEŞENLER

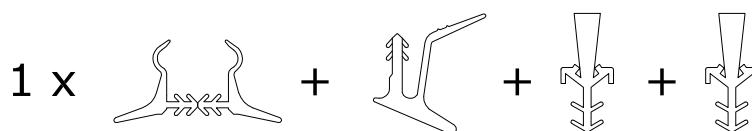
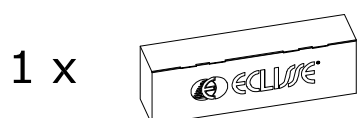
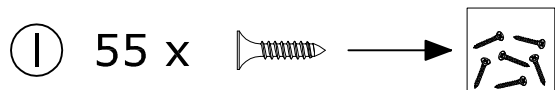
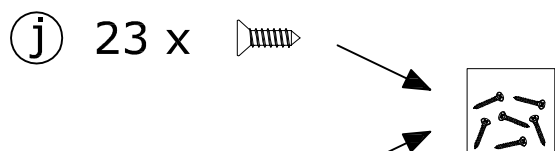
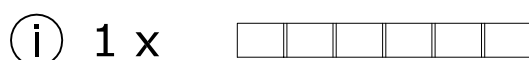
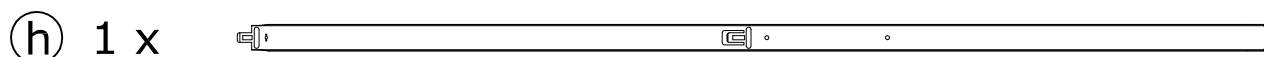
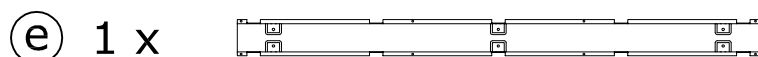
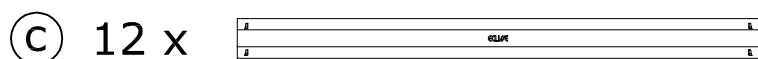
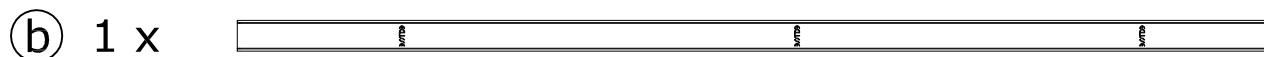

1

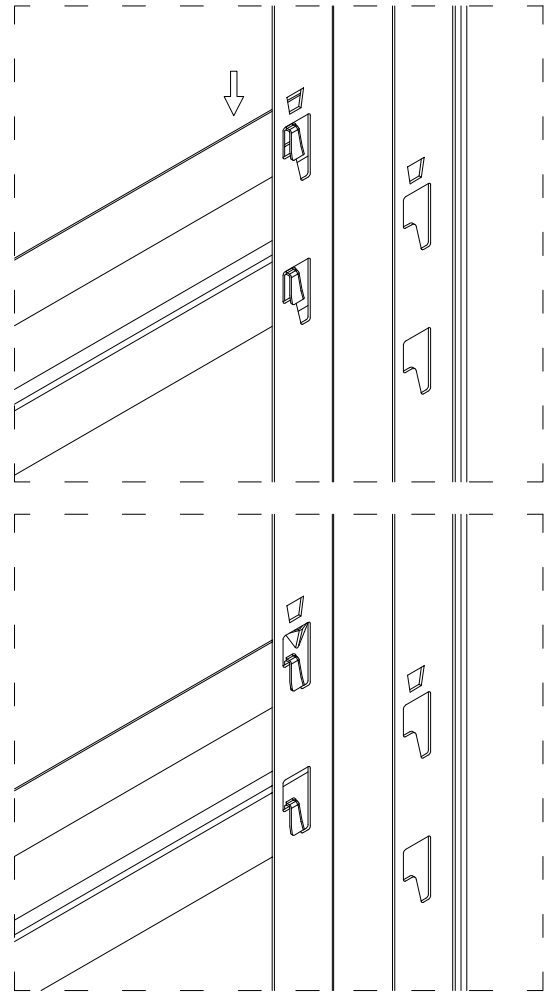
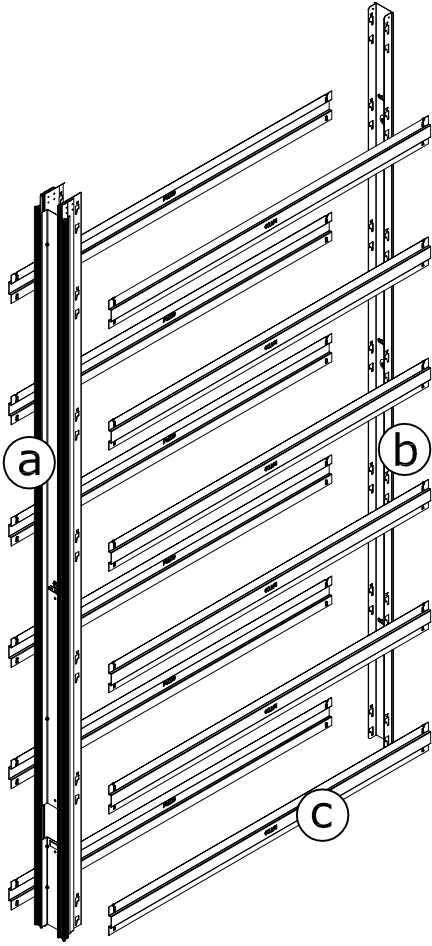

2

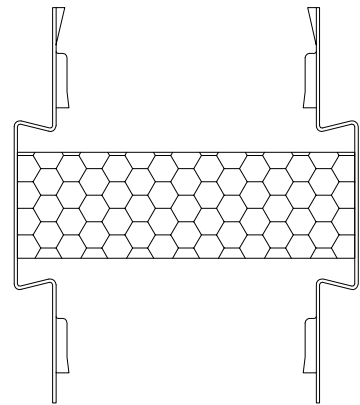
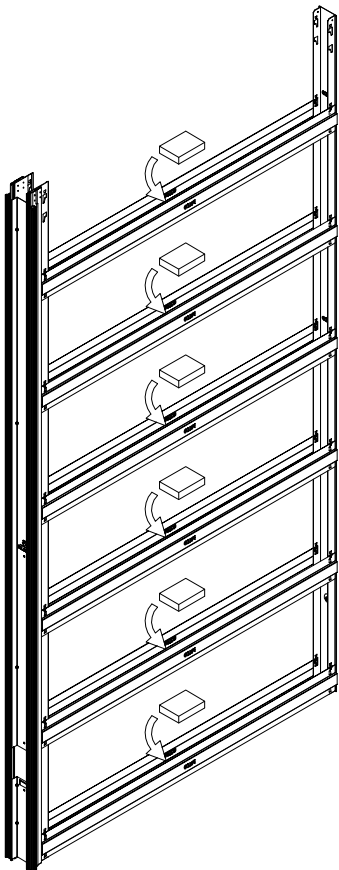
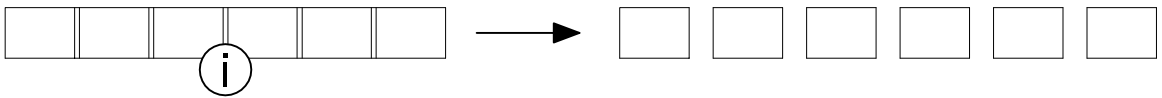

3

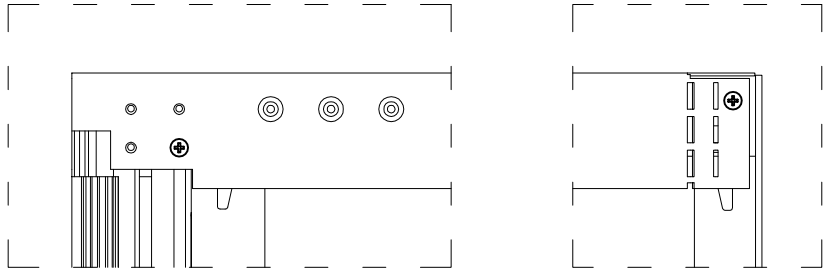
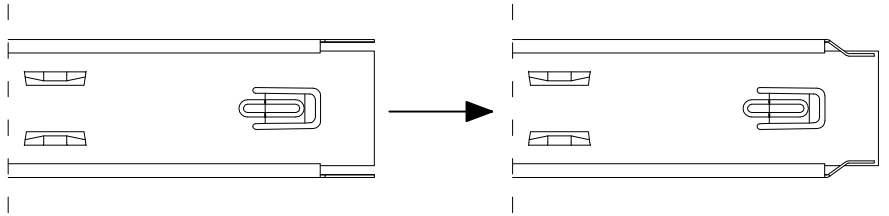
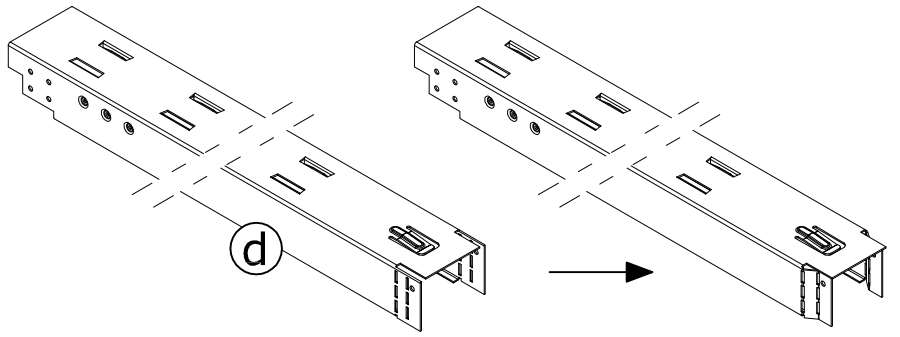
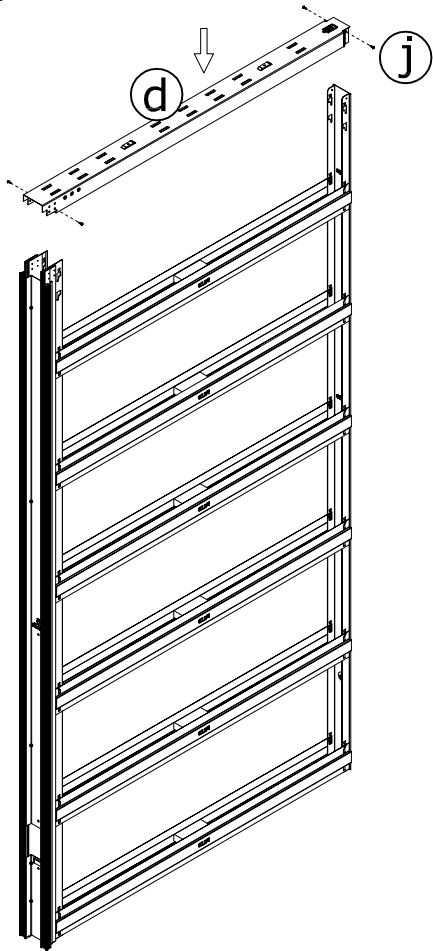

4

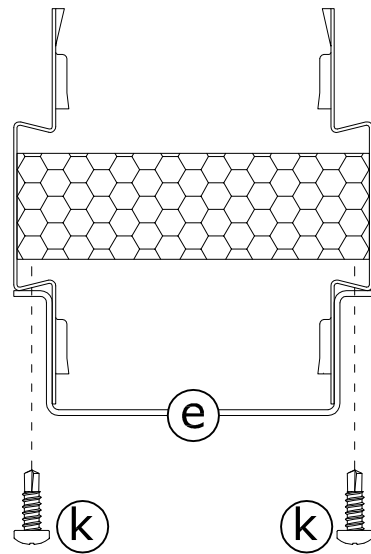
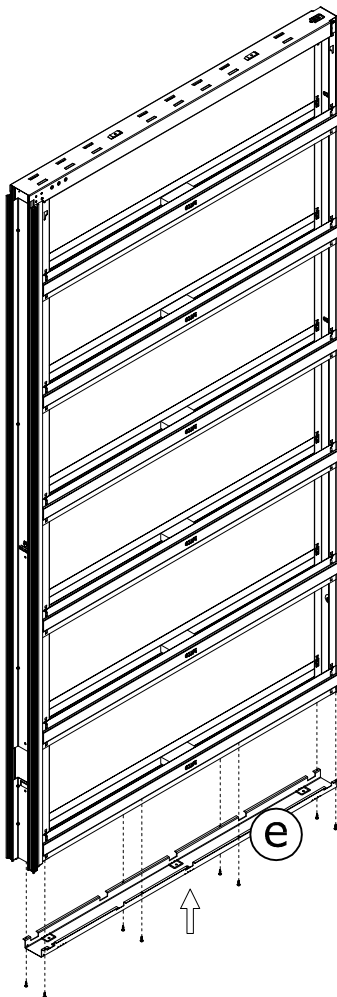

5

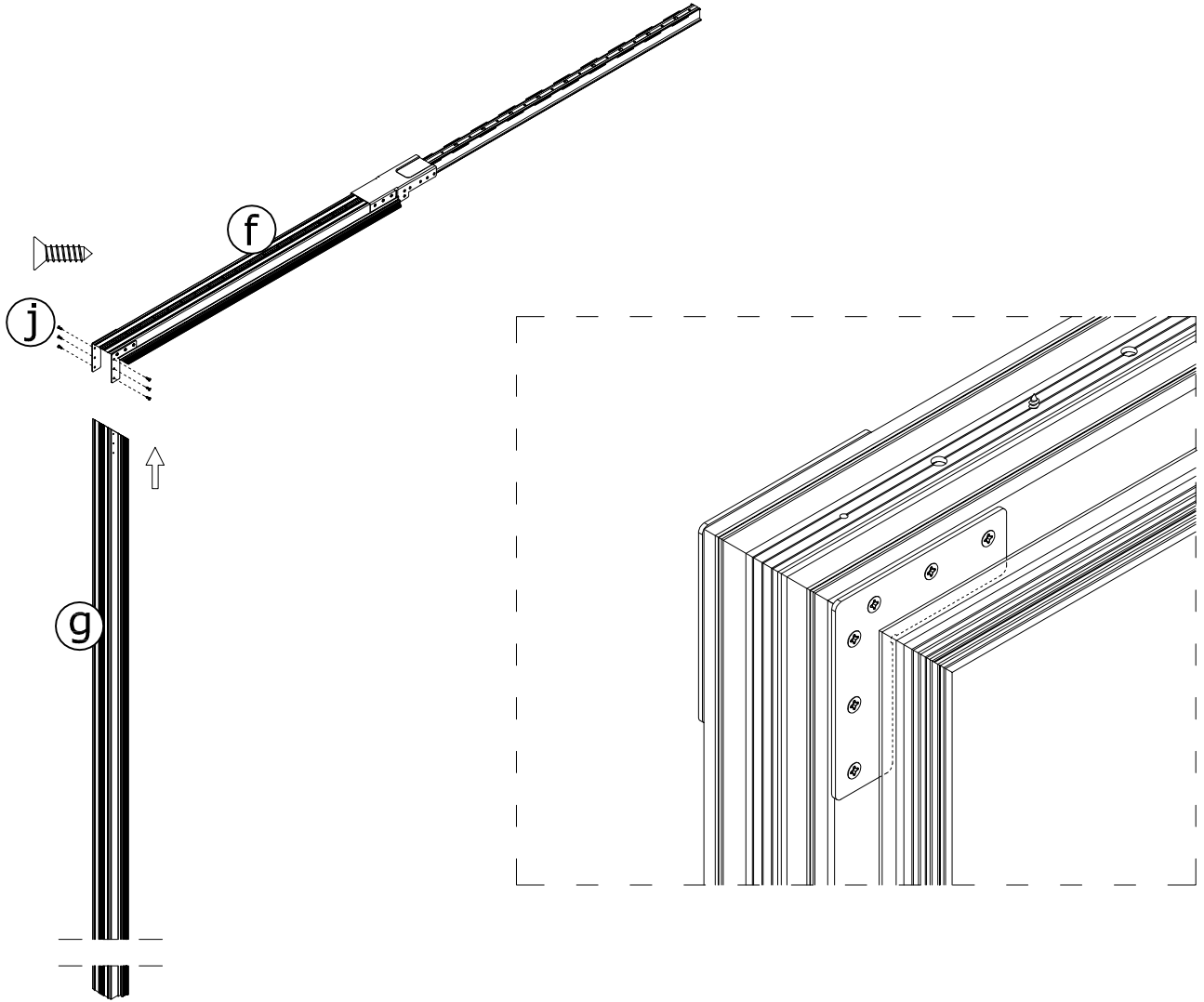

6

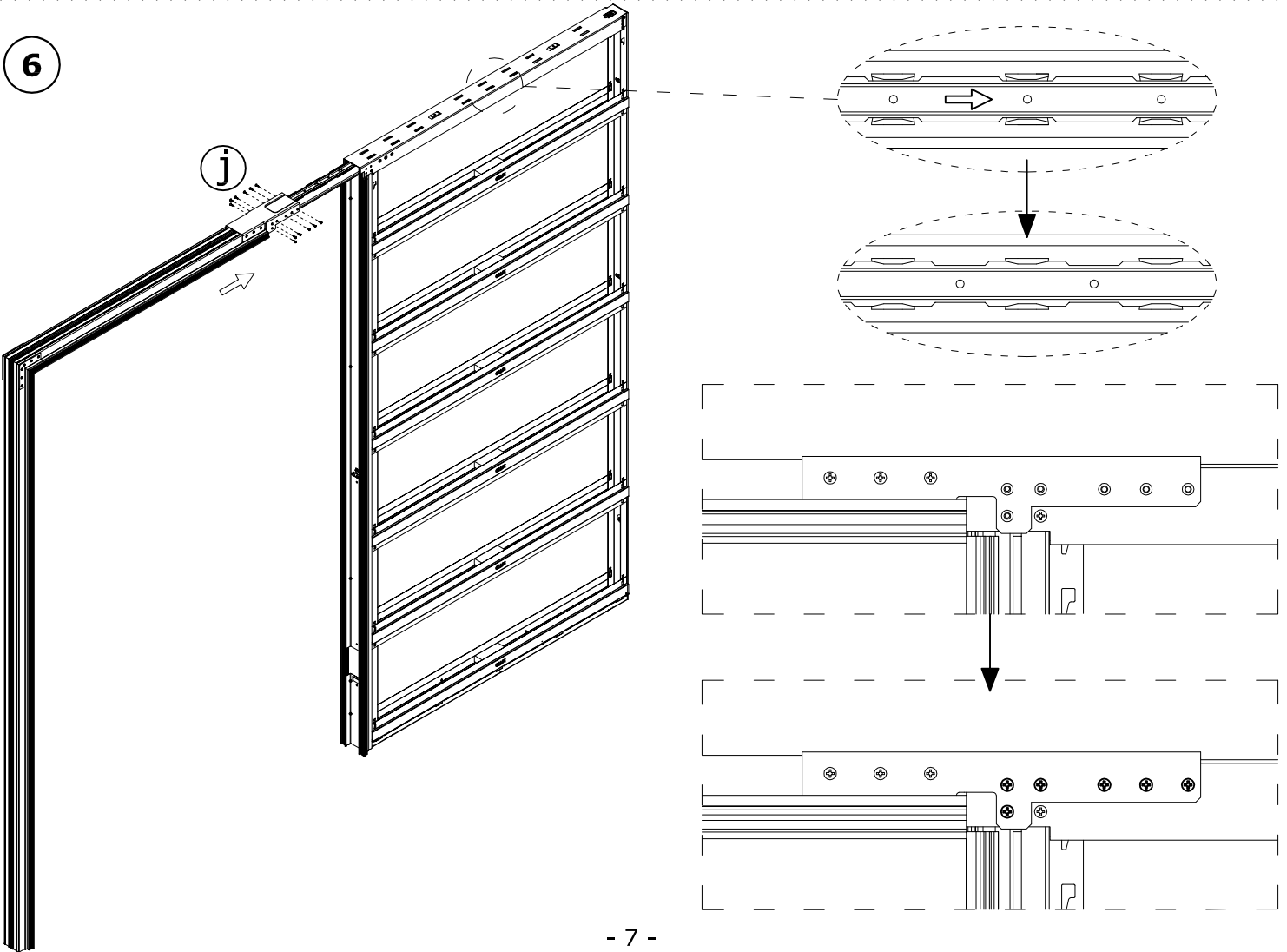

7

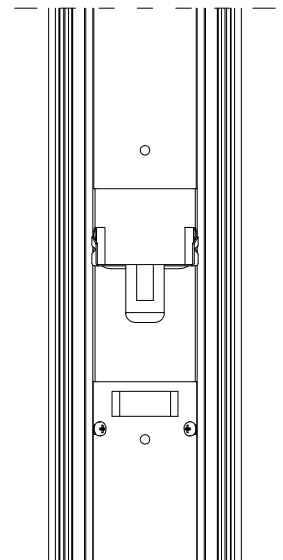
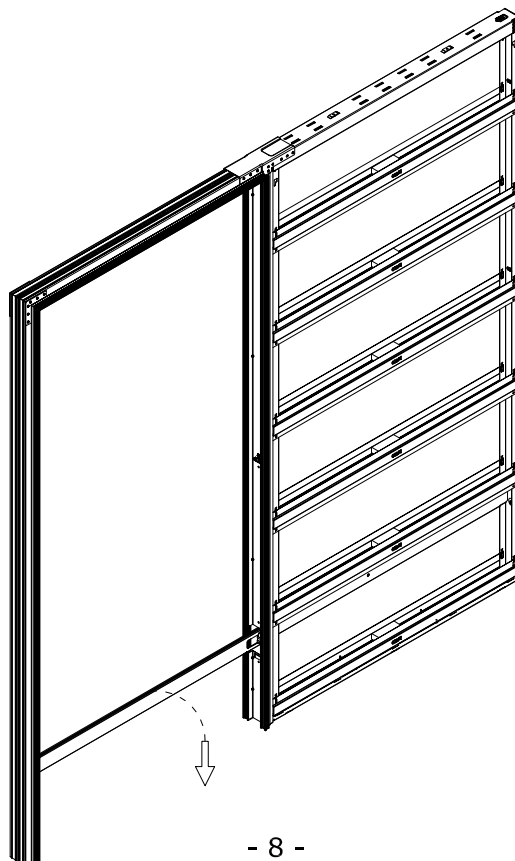
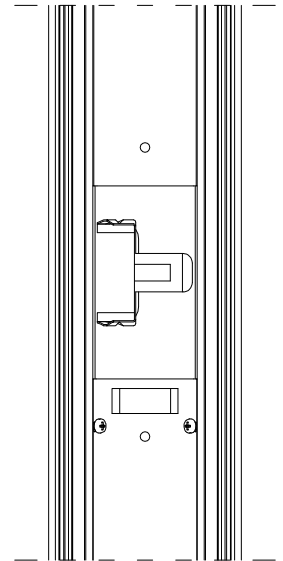
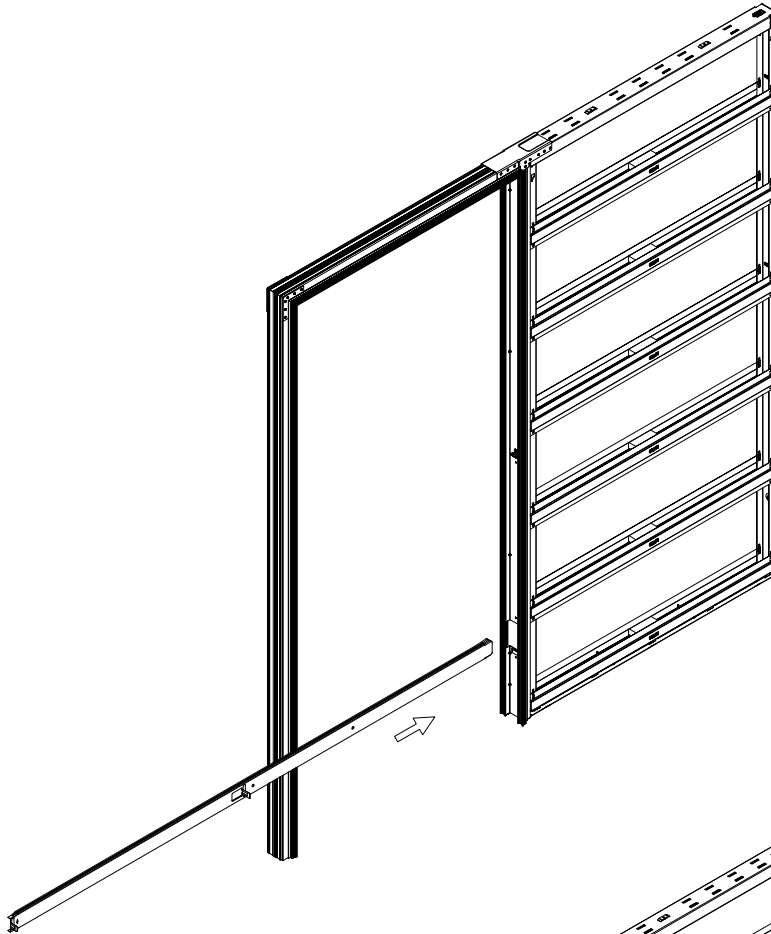
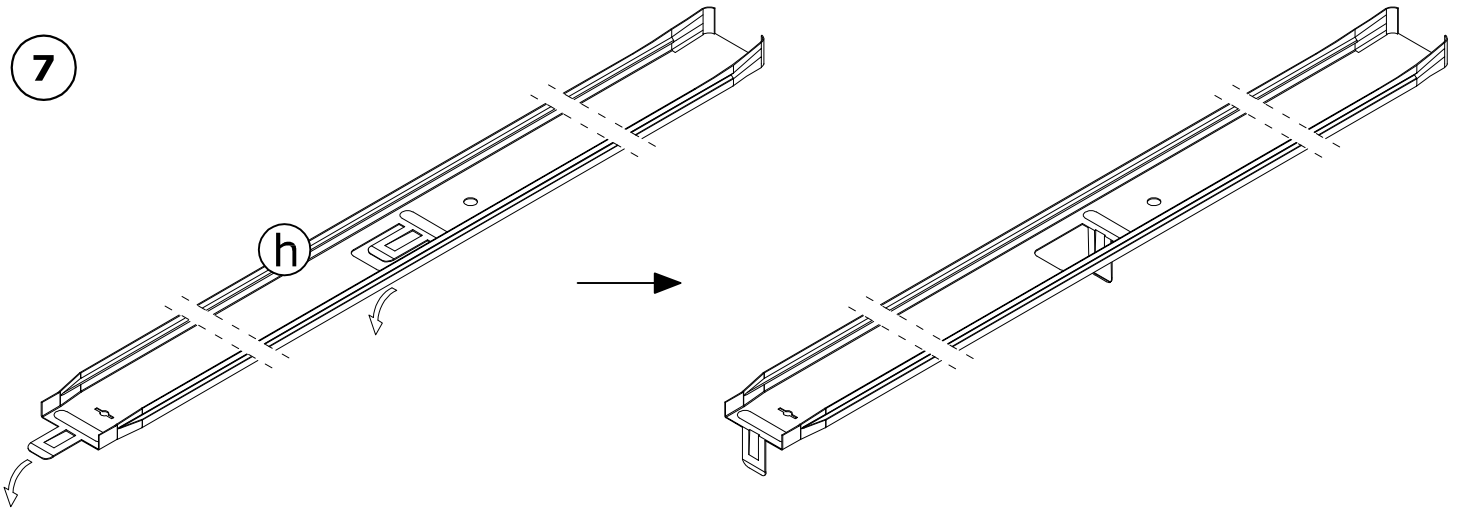

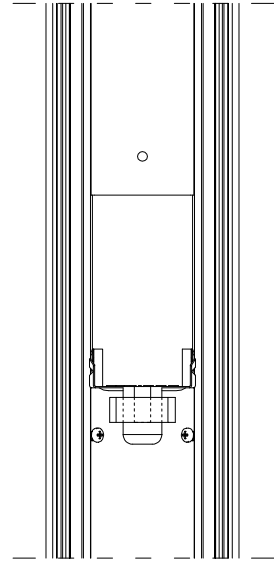
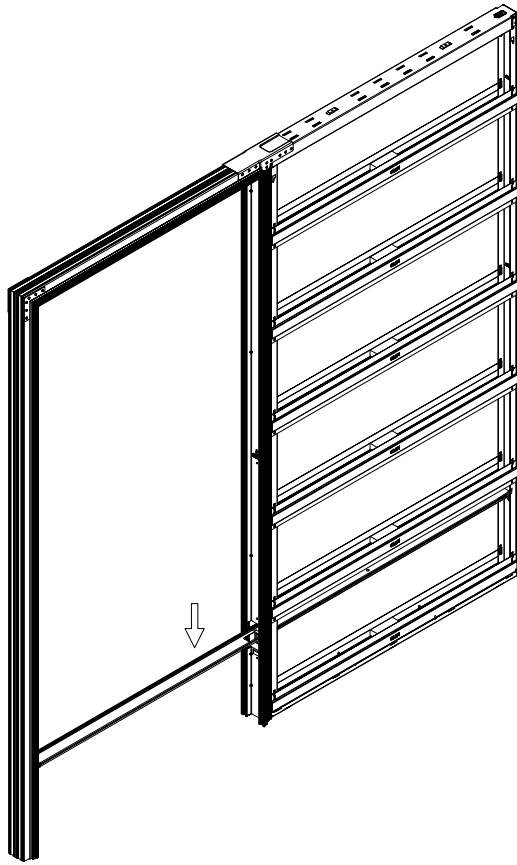

8

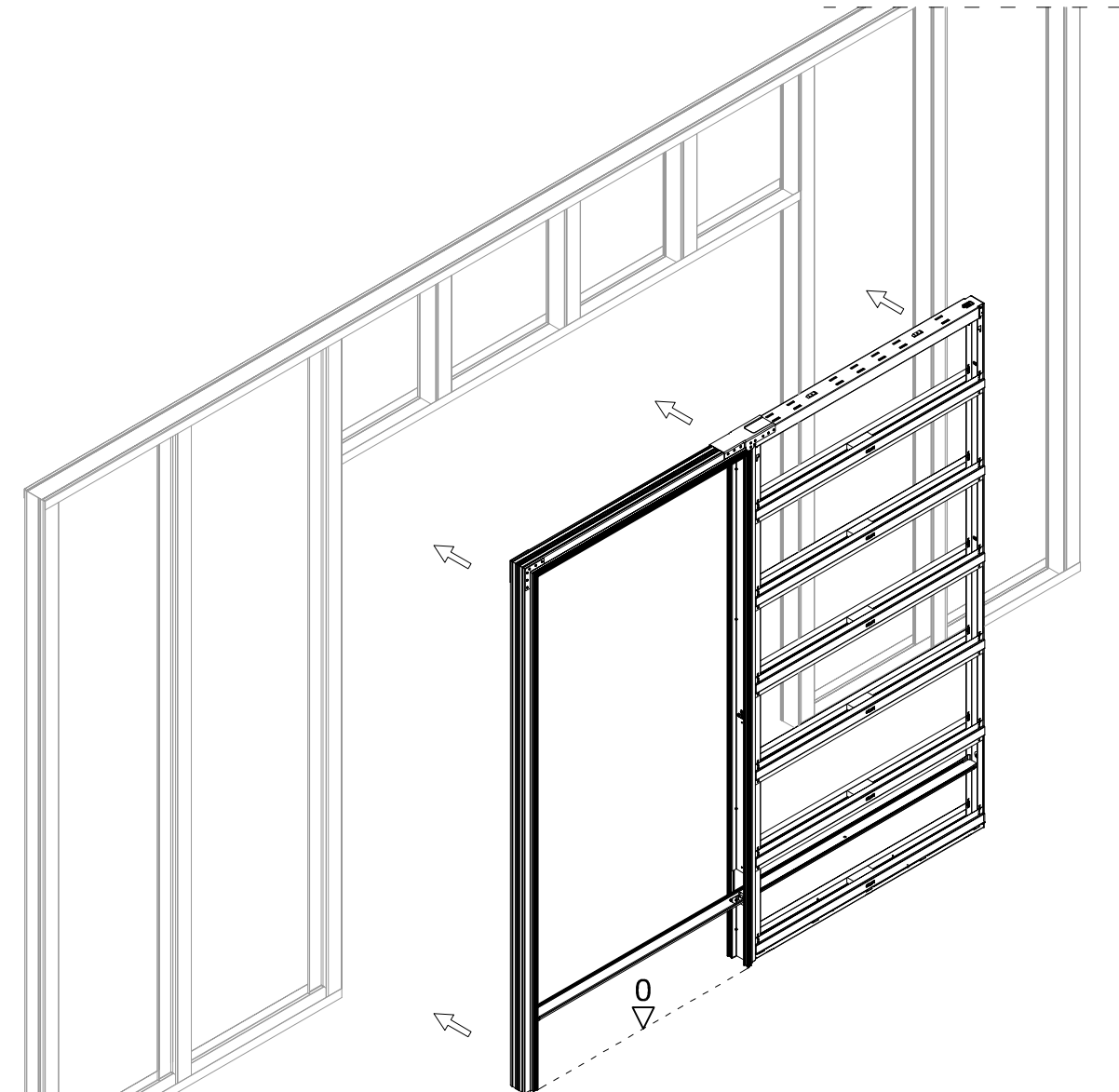

9

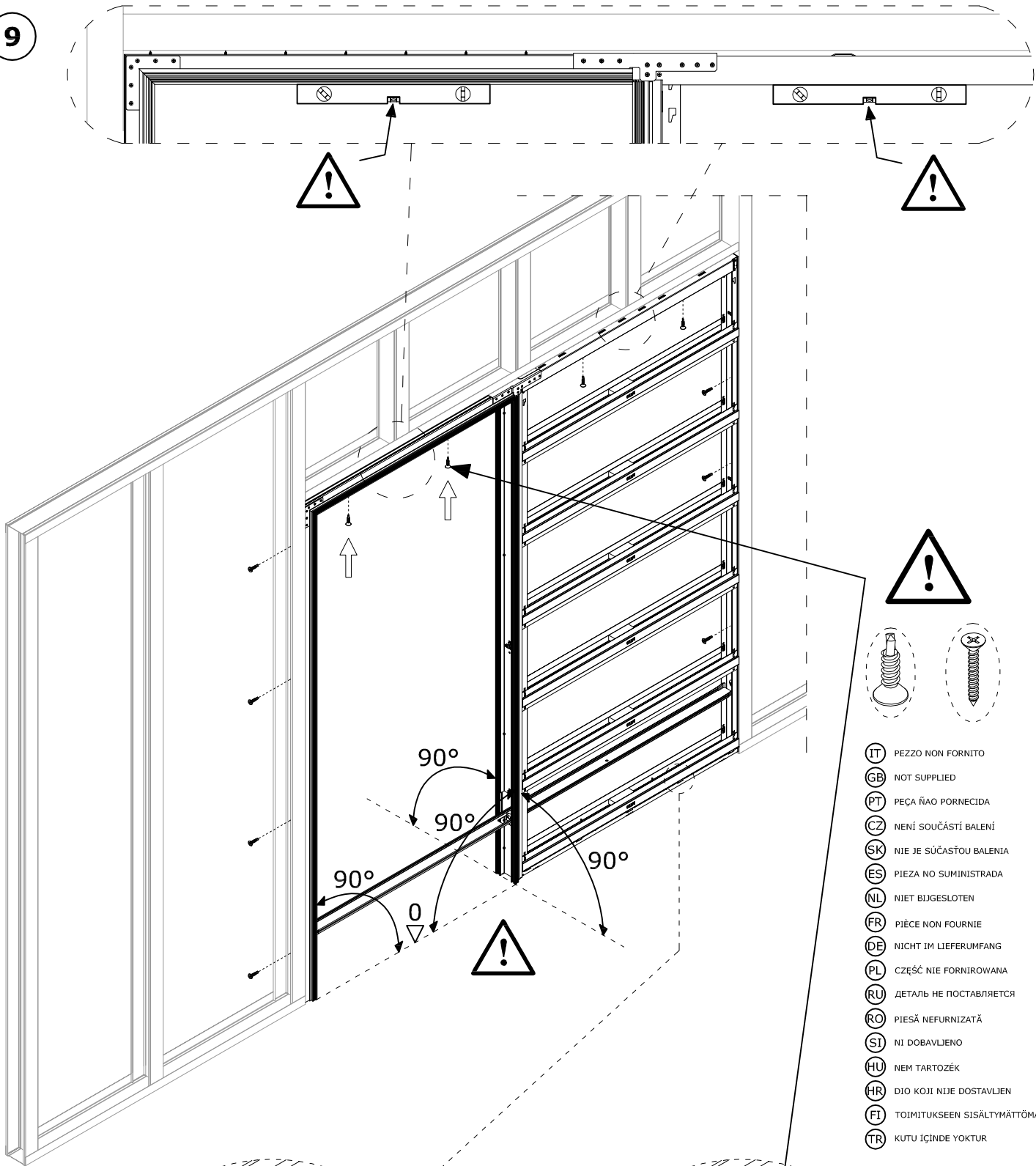

- Ⓜ IT PEZZO NON FORNITO
- Ⓜ GB NOT SUPPLIED
- Ⓜ PT PEÇA ÑAO PORNECIDA
- Ⓜ CZ NENÍ SOUČÁSTÍ BALENÍ
- Ⓜ SK NIE JE SÚČASŤOU BALENIA
- Ⓜ ES PIEZA NO SUMINISTRADA
- Ⓜ NL NIET BIJGESLOTEN
- Ⓜ FR PIÈCE NON FOURNIE
- Ⓜ DE NICHT IM LIEFERUMFANG
- Ⓜ PL CZĘŚĆ NIE FORNIROWANA
- Ⓜ RU ДЕТАЛЬ НЕ ПОСТАВЛЯЕТСЯ
- Ⓜ RO PIEȘĂ NEFURNIZATĂ
- Ⓜ SI NI DOBAVLJENO
- Ⓜ HU NEM TARTOZÉK
- Ⓜ HR DIO KOJI NIJE DOSTAVLJEN
- Ⓜ FI TOIMITUKSEEN SISÄLTYMÄTTÖMÄT OSAT
- Ⓜ TR KUTU İÇİNDE YOKTUR

10

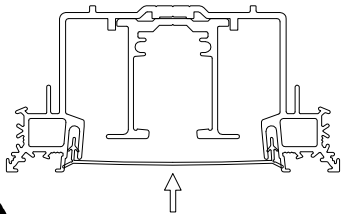
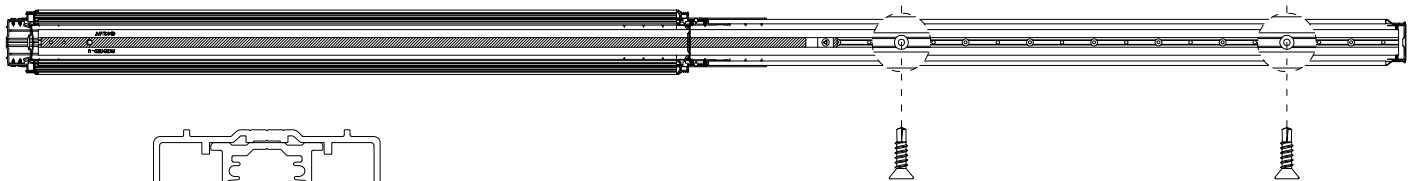
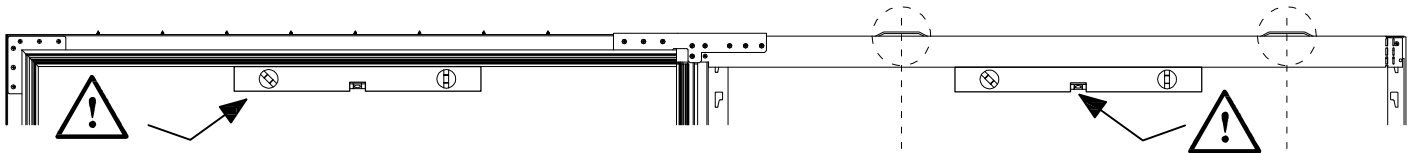
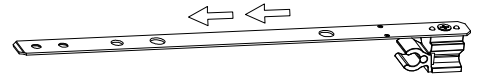
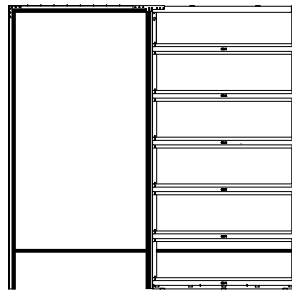
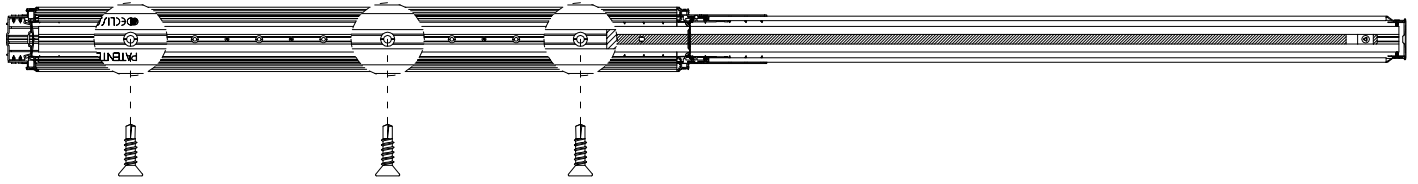
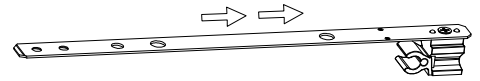
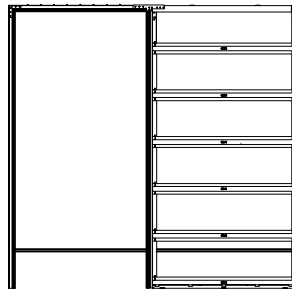
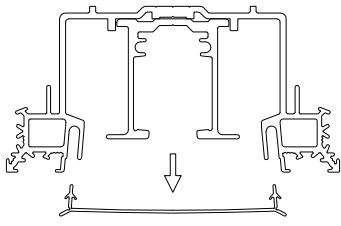

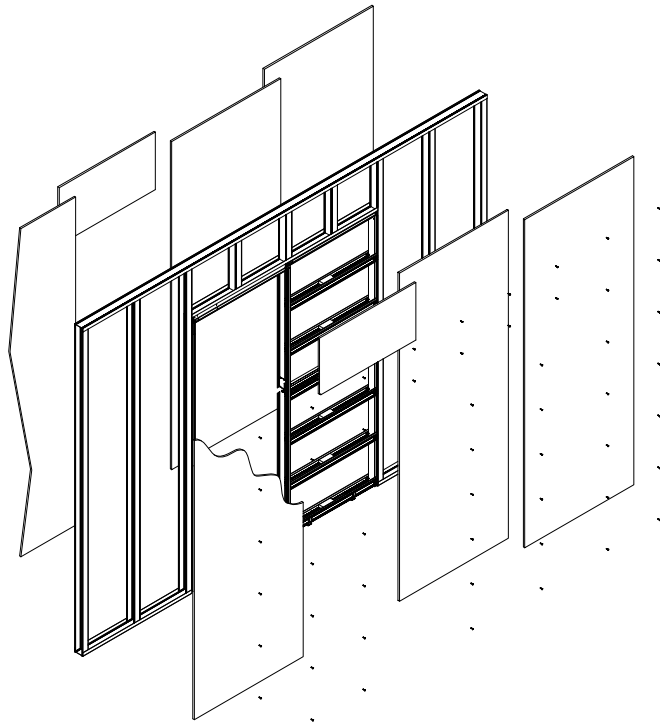

1

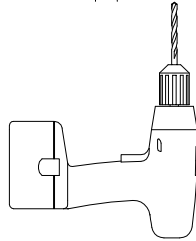
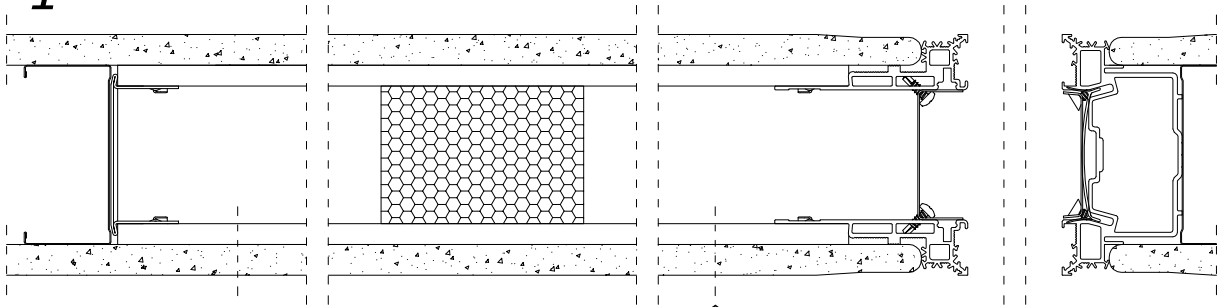

2

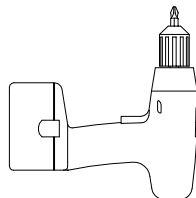
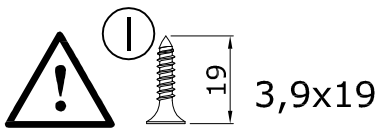
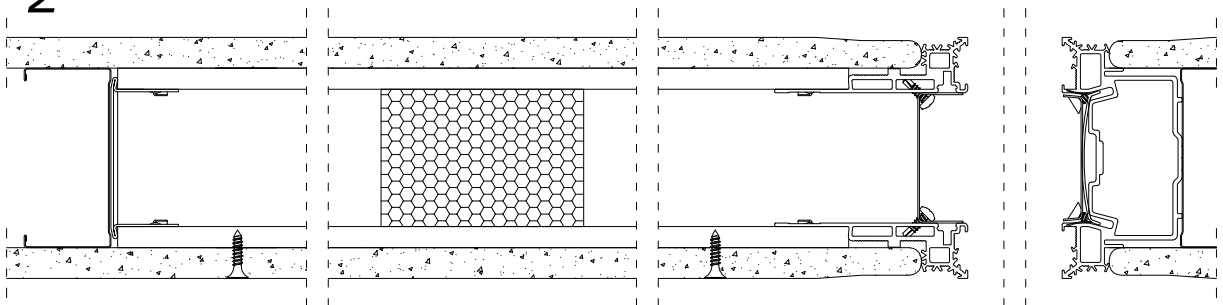

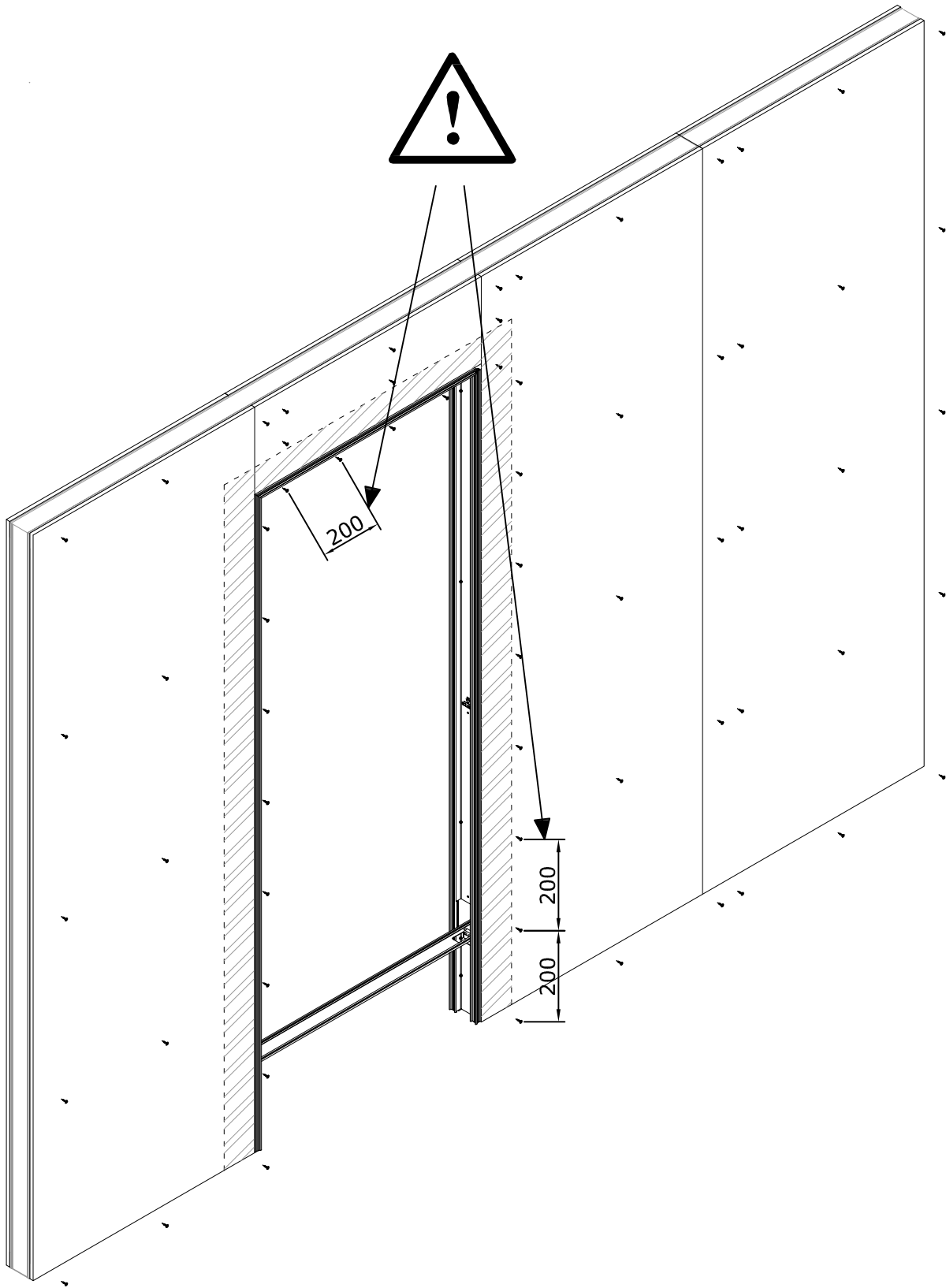

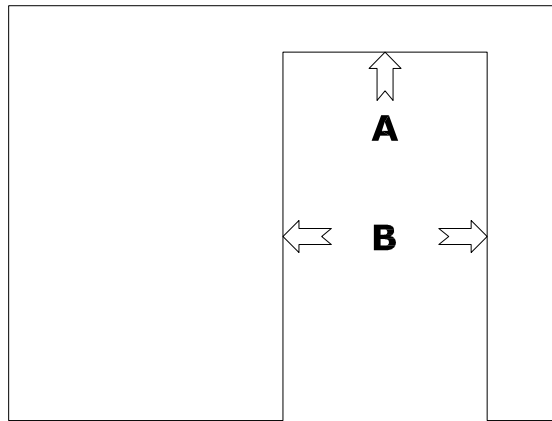

- (IT) APPLICAZIONE STUCCO O SCAGLIOLA
- (GB) APPLICATION OF PLASTER OR SCAGLIOLA
- (PT) APLICAÇÃO DE ALVENARIA OU GESSO
- (CZ) NANÁŠENÍ ŠTUKOVÉ OMÍTKY NEBO SÁDROKARTONOVÉHO TMELU
- (SK) NANÁŠANIE ŠTUKOVEJ OMIETKY ALEBO SADROKARTONÁRSKEHO TMELU
- (ES) APLICACIÓN DE ESTUCO O ESCAYOLA
- (NL) AANBRENGEN VAN PLAMUUR OF GIPS
- (FR) APPLICATION DE L'ENDUIT POUR PLAQUE DE PLÂTRE
- (DE) AUFBRINGUNG VON GIPS (BAUSEITS)
- (PL) NAŁOŻENIE MASY GIPSOWEJ LUB TYNKU NA KRAWĘDZIE OŚCIEŻNICY
- (RU) НАНЕСЕНИЕ ШТУКАТУРКИ ДЛЯ ВНУТРЕННИХ ИЛИ НАРУЖНЫХ РАБОТ
- (RO) APLICARE TENCUIALA SAU IPSOS
- (SI) NANAŠANJE KITA ALI MAVCA
- (HU) VAKOLAT VAGY SCAGLIOLA GIPSZMÁRVÁNY ALKALMAZÁSA
- (HR) NANOŠENJE ŠTUKATURA ILI GIPSANOG PRAHA
- (FI) TASOITUS- TAI RAPPAUSOHJE
- (TR) SIVA UYGULAMASI

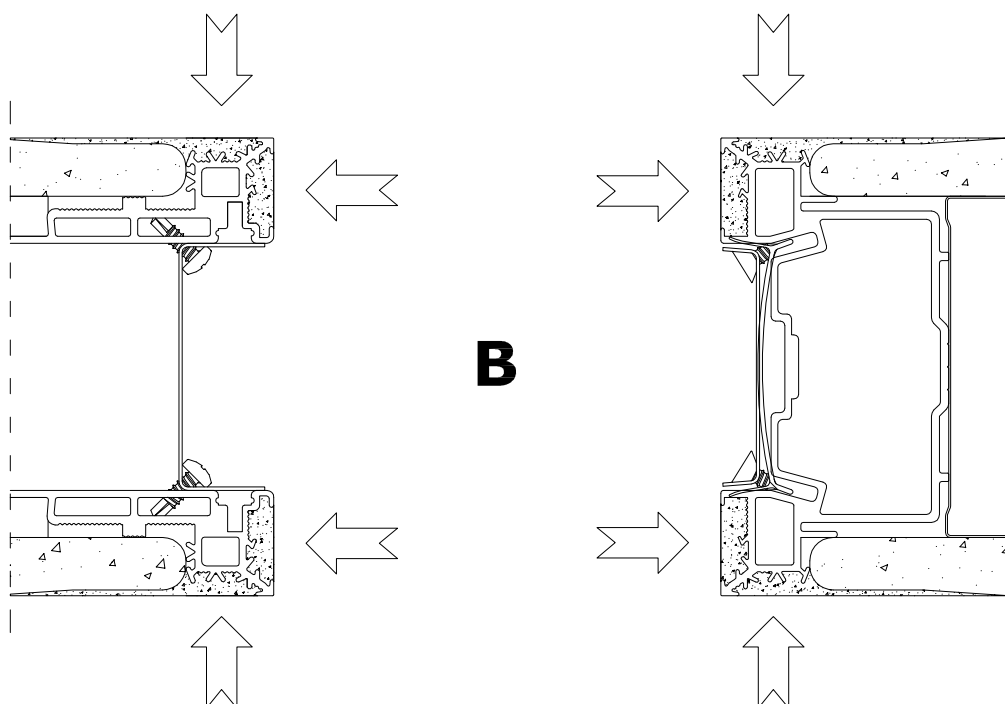
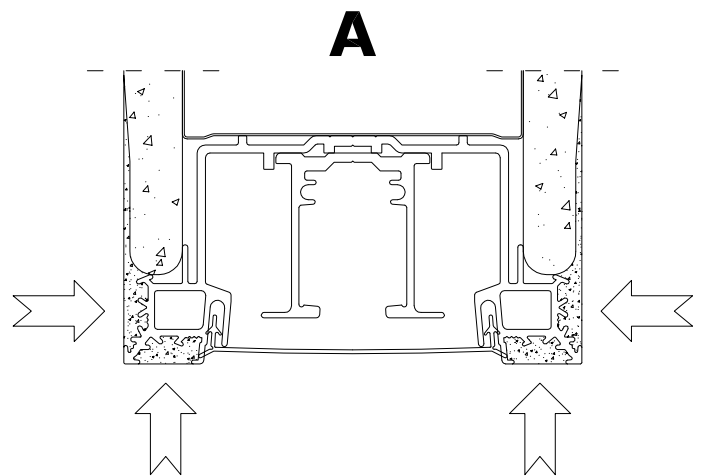

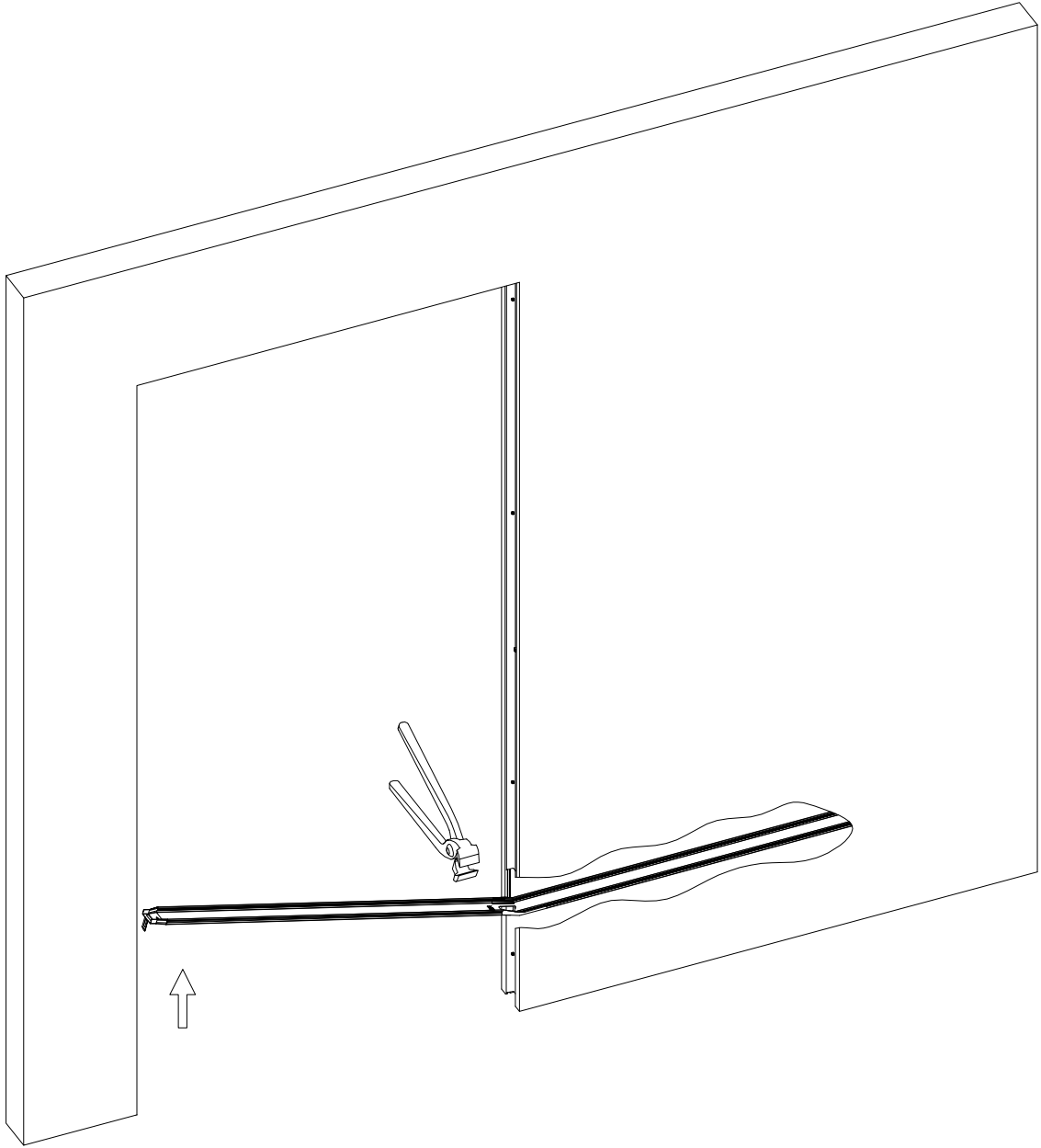

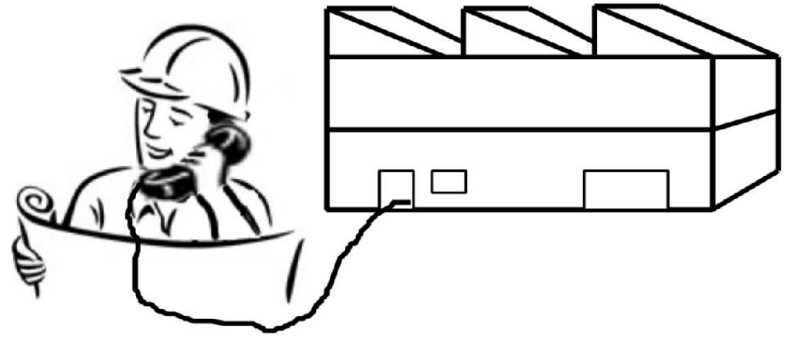

- IT ECLISSE s.r.l.** - Tel.:0438 980513 - Fax:0438 980 804 - eclisse@eclisse.it - www.eclisse.it
- GB ECLISSE UK** - Tel.:0044 845 4811977 - Fax:0044 1476 560951 - info@eclisse.co.uk - www.eclisse.co.uk
- PT ECLISSEDOOR** - Tel.:00351 912 934509 - helder.lopes@eclisse.com.pt - www.eclisse.com.pt
- BR ECLISSE BRASIL LTDA** - Tel:0055 27 3369 6200 - contato@eclisse.com.br - www.eclisse.com.br
- CZ ECLISSE ČR s.r.o.** - Tel.:00420 286888913 - Mobil:00420 603453645 - info@eclisse.cz - www.eclisse.cz
- SK ECLISSE SLOVAKIA S.R.O.** - Tel.:00421 48 4160700 - Fax:00421 48 4160701 - eclisse@eclisse.sk - www.eclisse.sk
- ES ECLISSE IBERIA, SL** - Tel.:0034 902 550878 - Fax:0034 902 550879 - eclisse@eclisse.es - www.eclisse.es
- NL MARSICA SPECIAL DOORS & FRAMES B.V.** - Tel.:0031 71 4050050 - Fax:0031 71 4050051 - info@marsica.eu - www.marsica.eu
- FR ECLISSE FRANCE SARL** - Tel.:0033 298905696 - Fax:0033 298901634 - info@eclisse.fr - www.eclisse.fr
- DE ECLISSE DEUTSCHLAND GMBH** - Tel.:0049 6162 968 17 00 - Fax:0049 6162 968 17 06 - info@eclisse.de - www.eclisse.de
- AT ECLISSE WIEN GMBH** - Tel.:0043 1 961 65 65 - Fax:0043 1 961 95 90 - eclisse@eclisse.at - www.eclisse.at
- PL ECLISSE POLSKA SP. Z.O.O.** - Tel.:0048 58 5311995 - Fax:0048 58 5322578 - eclisse@eclisse.pl - www.eclisse.pl
- RO ECLISSE EST SRL** - Tel.:0040 371 46 60 60 - Fax:0040 372 89 86 82 - info@eclisse.ro - www.eclisse.ro
- HU VENETO PORTE KFT** - Tel.:0036 30 538 9027 - Fax:0036 2244 1108 - toth.istvan@t-online.hu - www.eclisse.hu
- FI MUOTOLEVY OY** - Tel.:010 2814000 - myynti@muotolevy.fi - www.eclisse.fi
- TR ECLISSE SÜRME KAPI SİSTEMLERİ** - Tel./Fax:0090 212 222 1995 - yahya@eclisse.com.tr - www.eclisse.com.tr
- TN TECHNObAT** - Tel./Fax:00216 71 942429 - contact@technobat.com.tn - www.eclisse.tn
- US EURO ARCHITECTURAL, LCC** - Tel.:001 310 313 1400 - info@euro-arch.com
- IL H.G.L. BUILDING INNOVATIONS LTD** - Tel.:00972 3 5136100 - Fax:00972 3 6815308 - ola-g@h-g-trading.co.il - www.h-g-trading.co.il
- RU VISHERA-GROUP** - Tel. 007 495 518 96 89; 077 495 518 96 80; Fax: 007 495 518 96 85 - eclisse@vishera-group.ru - www.eclisse.ru

www.eclisseworld.com

