



SMART HOME&BUILDING

CATALOGUE ENGLISH



## Index

---

**General introduction**

2

**Smart products**

24

**View Wireless**

52

**By-me Plus**

84

**Well-contact Plus**

136

**Call-way and antibacterial solutions**

184

# The vision of a system of smart products and interconnected systems.

**View is a unique platform that includes connected systems and products for new builds, refurbishments or to modernise existing systems.** It entails a combination of solutions designed to favour comfort, energy efficiency and security, with matching styling, along with products customised to match all architectural styles. These interconnected products and systems liaise with one another continuously and in a perfectly integrated way to provide a concrete solution to the needs of those who build and enjoy spaces.

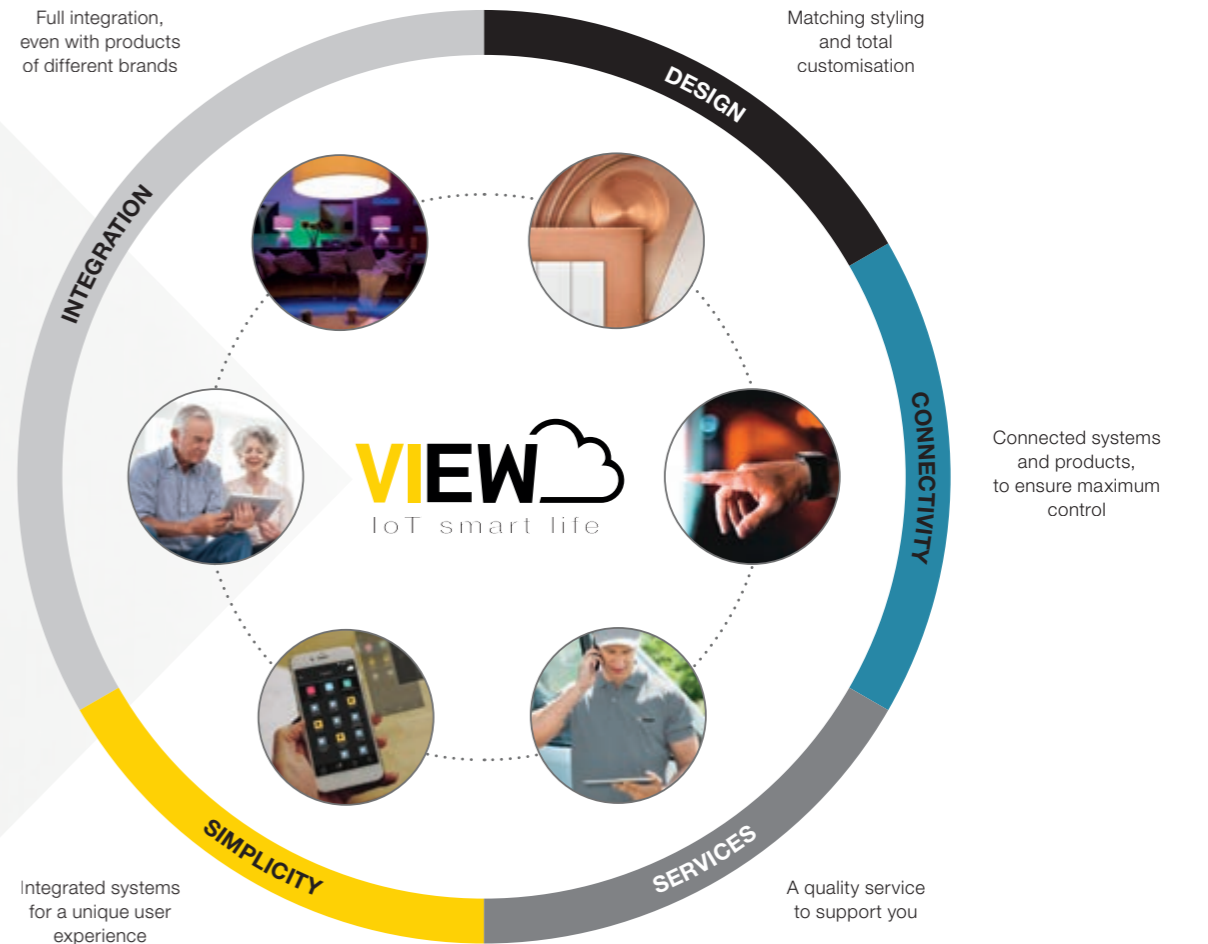

Solutions designed to ensure comfort, security and energy efficiency



View app

**A single app:** a unique experience and a user-friendly interface. You can manage, control and create scenarios. You can integrate the app with the IFTTT platform to integrate third-party devices. With the View app and Vimar Cloud, you're connected to your spaces wherever you are and are always up-to-date on what's going on inside and outside the building. Simply connected to your world.

## Versatile solutions

**Our solutions respect the identity of each setting.** You can expand your system in a smart, simple and constant way, for total control of your home and of the building.

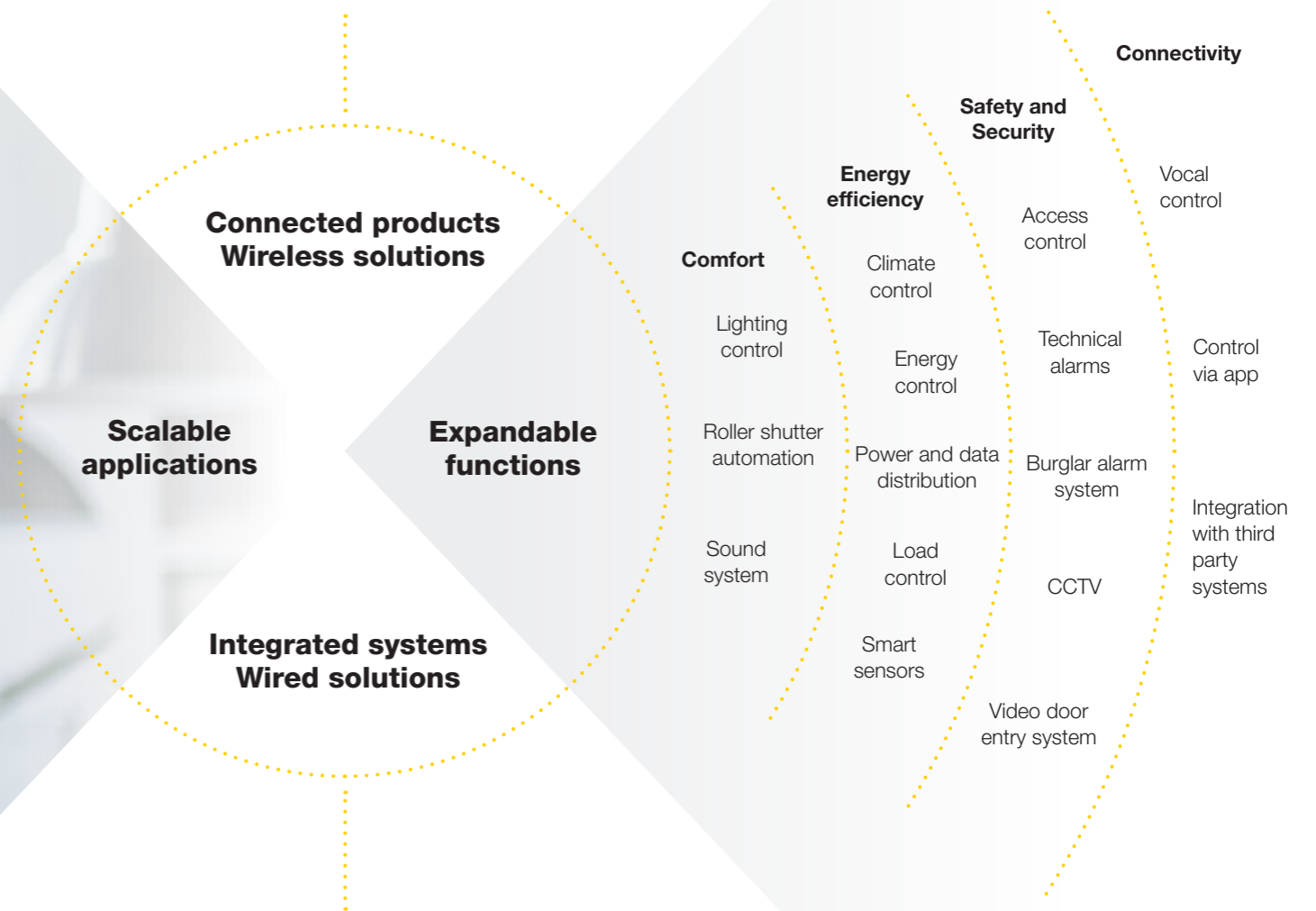

# Connected, wired or wireless systems.

The opportunity to design a complete, expandable and modular system

We offer high-tech, simple and versatile solutions to enhance the value of domestic settings. An extensive range of functions, both wired and connected, for every type of system capable of making it increasingly top-performing under the banner of maximum integration, interoperability and synergy also with international standards and protocols.



Standard functions for lights, roller shutters and temperature control



Centralised functions for lights and roller shutters



quid+

## Smart Home&Building

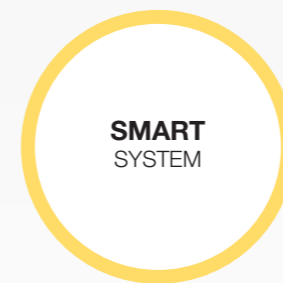

Individual connected functions, manageable with smart products and systems and controllable via app and voice

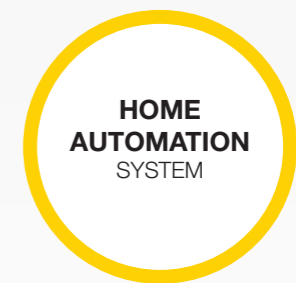

Complete and connected, integrated and expandable functions for all buildings

VIEW IoT smart life



	<b>SMART PRODUCTS</b> 	<b>VIEW WIRELESS SYSTEM</b> 
<b>ARCHITECTURE</b>		
<b>COMMUNICATION PROTOCOL</b>	Wi-Fi, Bluetooth, Zigbee, EnOcean	Standard Bluetooth mesh technology 5.0 *
<b>COMMUNICATION MEDIA</b>	Wireless	Wireless
<b>INSTALLATION / PROGRAMMING</b>	Specific for each product	With View Wireless app for Android, iOS platforms
<b>NUMBER OF DEVICES</b>	n.d.	64
<b>FUNCTIONS</b>		
<b>COMFORT</b>	<ul style="list-style-type: none"> <li>Lighting control: ON/OFF/dimmer</li> </ul>	<ul style="list-style-type: none"> <li>Lighting control: ON/OFF</li> <li>Curtain and roller shutter automation</li> <li>Scenarios</li> </ul>
<b>ENERGY EFFICIENCY</b>	<ul style="list-style-type: none"> <li>ON/OFF climate control on 2-pipe systems</li> </ul>	<ul style="list-style-type: none"> <li>ON/OFF multi-zone climate control on 2-pipe systems</li> <li>Energy production/consumption meter</li> <li>Control of 4 loads/anti power black-out</li> </ul>
<b>SECURITY</b>	No	<ul style="list-style-type: none"> <li>Access management</li> </ul>
<b>ADDITIONAL FUNCTIONS</b>		
<b>USER CONFIGURATION</b>	Specific for each product, depending on the app used	<ul style="list-style-type: none"> <li>Scenarios (max 16)</li> </ul>
<b>INTEROPERABILITY WITH OTHER SYSTEMS</b>	No	No
<b>LOGIC FUNCTIONS</b>	No	No
<b>CONNECTIVITY</b>		
<b>MANAGEMENT</b>	Specific for app	With View app for Android, iOS platforms
<b>INTEGRATION WITH IoT CLOUD PLATFORMS</b>	<ul style="list-style-type: none"> <li>Google Assistant</li> <li>Amazon Alexa</li> <li>Philips Hue</li> </ul>	<ul style="list-style-type: none"> <li>Google Assistant</li> <li>Amazon Alexa</li> <li>Siri, Apple HomeKit</li> <li>IFTTT</li> </ul>
<b>REMOTE MAINTENANCE</b>	No	No

\* Devices also equipped with Zigbee 3.0 standard protocol (only to control lights, roller shutters and generic loads)

	<b>BY-ME PLUS SYSTEM</b> 	<b>WELL-CONTACT PLUS SYSTEM</b> 
<b>ARCHITECTURE</b>		
<b>COMMUNICATION PROTOCOL</b>	Proprietary By-me	KNX standard (SECURE standard supported) KNX standard (SECURE standard supported)
<b>COMMUNICATION MEDIA</b>	<ul style="list-style-type: none"> <li>2 twisted flexible wire Bus with possible wireless extension on EnOcean technology</li> <li>Ethernet LAN (for gateway and touch screen)</li> </ul>	<ul style="list-style-type: none"> <li>2 rigid wire bus</li> <li>Ethernet LAN (for web server and touch screen)</li> </ul>
<b>INSTALLATION / PROGRAMMING</b>	With View Pro app for Windows Android, iOS platforms	With ETS software (for Windows platforms)
<b>NUMBER OF DEVICES</b>	From 32 to 300	More than 60.000 addressable
<b>FUNCTIONS</b>		
<b>COMFORT</b>	<ul style="list-style-type: none"> <li>Lighting control: ON/OFF, control, colour</li> <li>Advanced curtain and roller shutter automation</li> <li>Scenarios</li> <li>Sprinkler system</li> <li>Sound system</li> <li>Logic programs</li> </ul>	<ul style="list-style-type: none"> <li>Lighting control: ON/OFF, control, colour</li> <li>Advanced curtain and roller shutter automation</li> <li>Scenarios</li> <li>Sprinkler system</li> <li>Logic programs</li> </ul>
<b>ENERGY EFFICIENCY</b>	<ul style="list-style-type: none"> <li>ON/OFF multi-zone and proportional climate control on 2-pipe/4-pipe systems with fan coil, humidity control and climate control</li> <li>Energy production/consumption meter</li> <li>Control of 16 loads/anti power black-out</li> </ul>	<ul style="list-style-type: none"> <li>Advanced climate control</li> </ul>
<b>SECURITY</b>	No	<ul style="list-style-type: none"> <li>Real time access management from reception with scheduling possibility on hourly/daily basis</li> <li>Up to 7 profiles that can be managed in the access card</li> </ul>
<b>ADDITIONAL FUNCTIONS</b>		
<b>USER CONFIGURATION</b>	<ul style="list-style-type: none"> <li>Scenarios</li> </ul>	No
<b>INTEROPERABILITY WITH OTHER SYSTEMS</b>	<ul style="list-style-type: none"> <li>By-alarm burglar alarm system</li> <li>Elvox Video Door Entry System</li> <li>Elvox cameras</li> <li>Dali2</li> </ul>	<ul style="list-style-type: none"> <li>With all the third-party systems/devices fitted with interfaces/gateways</li> </ul>
<b>LOGIC FUNCTIONS</b>	<ul style="list-style-type: none"> <li>By-me Plus logic programmes in the gateway</li> </ul>	<ul style="list-style-type: none"> <li>Programmable logics with ETS software</li> <li>Logic programmes (max 30) in the web server</li> </ul>
<b>CONNECTIVITY</b>		
<b>MANAGEMENT</b>	With View app for Android, iOS platforms	<ul style="list-style-type: none"> <li>ith By-web app for Android, iOS platforms</li> <li>With Well-contact Suite software</li> <li>for Windows platforms </li> </ul>
<b>INTEGRATION WITH IoT CLOUD PLATFORMS</b>	<ul style="list-style-type: none"> <li>Google Assistant</li> <li>Amazon Alexa</li> <li>Siri, Apple HomeKit</li> <li>IFTTT</li> <li>Philips Hue</li> </ul>	<ul style="list-style-type: none"> <li>Integration with third party devices possible</li> </ul>
<b>REMOTE MAINTENANCE</b>	Yes, via View Pro app	Yes, via ETS software

ADVANCED  
TRADITIONAL  
SYSTEM

# QUID.

## Advanced traditional system

To control lights and roller shutters in traditional systems.  
The evolution of wired systems, affording maximum functionality and reliability.



### QUID for lighting control. Innovative and silent relay

- For central control**
- QUID offers the possibility of creating a central power-off control.
  - Used to turn off all the lights with a single gesture. Moreover, the presence of a pilot light reveals whether the lighting is active in any point connected.
- Silent**
- Unlike standard electromechanical devices, the change of state proves more silent, thanks to Vimar's patented magnetic relay.
- Secure**
- If the push button remains active, the relay does not overheat because the current is not present after the change of state.
- Energy saving**
- It is not powered, an advantage for energy saving and respect for the environment.

PATENTED  
VIMAR

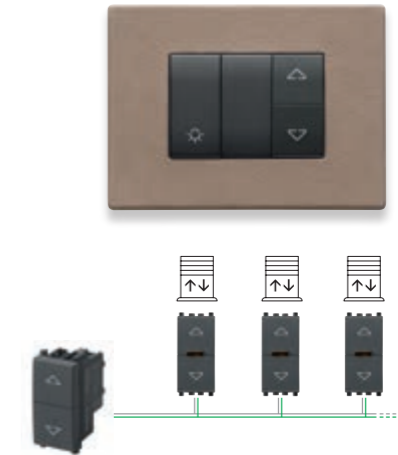

### QUID for roller shutters. Innovative electronic device.

- Central control**
- The device automates the curtains and roller shutters, enabling control in groups, load cut-off at the limit stop and saves the favourite position.
- Safe and reliable**
- Cuts off the voltage at the limit stop to avoid the motor remaining under voltage and being damaged.



SMART SYSTEM



## Smart products.

Smart devices to boost the functions of traditional systems

VIEW  
IoT smart life

**Solutions designed to boost the functions of traditional systems, minimising the work and labour required,** like the radio frequency controls which require no electrical power supply, thermostats and timer-thermostats to manage the temperature in an easy and user-friendly way even remotely via the By-clima App, the stand-alone sound system that uses Bluetooth® technology to play music anywhere in the home from a mobile device, or the Wi-Fi access point that can be used to improve building connectivity.



### Smart Climate Control.

Surface mounting thermostats and timer-thermostats come with user-friendly controls and easy-to-read controls. They allow for simple and comprehensive temperature control, whether you are at home or away, and display consumption levels to encourage energy saving. And what's more, with the timer-thermostat the boiler can be switched on and off with daily or weekly settings. With the user-friendly By-clima App, you can manage Wi-Fi and GSM devices remotely using your smartphone.

### Radio frequency controls.

Wireless and battery-free. Battery-free controls send the signal to the connected 2-way switch to which they are associated, exploiting the power supply provided by the built-in electro-dynamic generator.

- **Versatile:** they can be fitted onto any surface, such as wood, glass, and walls. The system can be expanded up to 15 control points.
- **Speedy installation:** no need for masonry work or repainting; no flush mounting boxes necessary.
- **You can add or reposition** wireless controls for lights, roller shutters, curtains and socket outlets at any time to suit your particular needs.



### Wi-Fi access point.

The simplest solution for extending your Internet connection throughout your home, even to areas that are not reached by the Wi-Fi router signal or where the signal is weaker, providing coverage for all the environments thanks to a stylish product integrated into the series.



### Stand-alone speaker system.

Thanks to Bluetooth® technology, mini stand-alone systems can be created quickly and simply. Your smartphone connects automatically so you can listen to your favourite music in the room.





SMART SYSTEM



## Elvox door entry.

### Tab 7S Up and Tab 5S Up smart video door entryphones

**Communicating with outside your home is even simpler and even smarter.** Designed specifically to adapt elegantly to various domestic styles, the new products accommodate both the need for speedy installation and easy programming as well as remote control. **Ideal for refurbishments or for new buildings.**



TAB 7S UP



TAB 5S UP



Immediately connected to your life.  
To answer, wherever you are.



**Video Door app: multi-system, multi-lingual and multi-user.**

With a single app, you can manage up to 5 different video door entry systems, forward calls to up to 10 different users, choose between 8 language versions and manage and receive notifications from 5 different systems, with both Due Fili Plus and IP technology.

SMART SYSTEM



## View Wireless.

Installation with mesh Bluetooth® wireless technology system



To keep everything under control and **manage lighting, roller shutters or motorised curtains, control energy consumption, temperature control and manage scenarios** with the utmost simplicity using your smartphone via **App or directly by voice**. Ideal for renovations or to boost the functions of an existing system, it is a useful means of support for the elderly and people with restricted mobility.



ALEXA VOICE ASSISTANT



CLIMATE CONTROL



ENERGY



LIGHTS



CURTAINS AND ROLLER SHUTTERS



ACCESSES

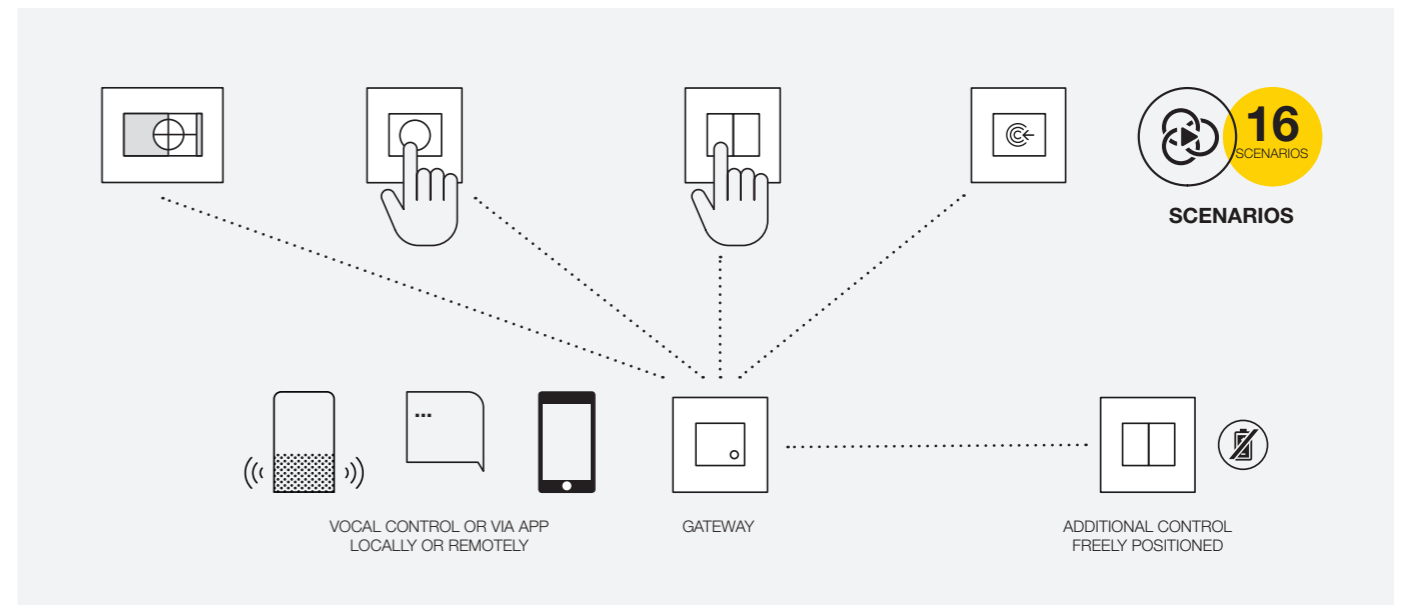

View app

### VIEW APP: FUNCTION CONTROL.

The app is designed for the user to control devices, locally and remotely.



View Wireless app

### VIEW WIRELESS APP: USER-FRIENDLY CONFIGURATION.

The app is designed to configure the system thanks to simple self-explanatory screens to create environments and associate the connected devices.



## Installation with integrated home automation system

The **By-me Plus home automation system** consists of a range of intercommunicating devices designed to improve the comfort, the energy efficiency and the safety of everyday life, using automatic devices involving all the installed functions.

The **modularity** and **depth of the range** and the **segmentation** of the wiring series can: accommodate the functional requirements of residential customers and those of small service and hospitality industries, for both new builds and refurbishments; be used for updating and expanding systems even later on, without any further masonry work; meet the aesthetic and price needs of the end user.



COMFORT



ENERGY EFFICIENCY



SECURITY

### SIMPLE CONTROL THANKS TO THE VIEW APP.

Local and remote control and supervision, easy to operate, also thanks to user-friendly interfaces.



View app



### Maximum integration.

**By-me Plus** can be integrated with the functions available, including safety functions (burglar alarm systems, video door entry systems, CCTV) or automation, which also carry out complex, controlled or automatic actions (scheduled or according to the conditions).



ELVOX VIDEO DOOR ENTRY SYSTEM



ELVOX CCTV VIDEO SURVEILLANCE



BY-ALARM BURGLAR ALARM SYSTEM



# Well-contact Plus. KNX

## Automation system on KNX standard

**Automation for the whole building, with integrated functions and centralised monitoring.**  
 Flexible, interoperable, safe and modular, Well-contact Plus is the system developed on the KNX standard, for complete building management. Specifically, in the hotel, service and residential sectors, the system is used to create centralised management systems that permit the integration, supervision and constant management of lights, temperature, security, energy and accesses, guaranteeing ease of use.



COMFORT



ENERGY EFFICIENCY



SECURITY

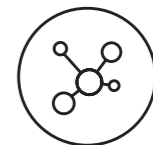

INTEGRATION

**Total supervision**

The great advantage of the Well-contact Plus system is that it allows supervision of all the functions and the centralised management of the whole building.

**Local supervision is performed** via devices installed in each room, used to locally manage the different functions (touch controls, thermostats, touch screens, etc.) or with supervisors (touch screen, multimedia video touch screen, etc.).

**Remote supervision is assured by the Web server** which is used to manage the Well-contact Plus automation system via a PC, smartphone, tablet or touch-screen with a browser for viewing the web pages. Remote control is assured via a local LAN or Wi-Fi network to supervise and control all the devices in the system; view the system status, events log, etc. at any time; view the feed from the IP cameras.





## Call-way and Antibacterial solutions.

### Emergency call system and wiring series with antibacterial treatment

**Integrated system for hospital facilities, private clinics and care homes.** From small clinics to more complex healthcare facilities, it is essential for call devices to always ensure timely, reassuring and scalable intervention and comprehensive assistance.

**Call-way** is a modular call system that promptly and efficiently manages emergencies, making the job of medical staff easier. The dialogue with the PC enables continuous monitoring and ensures maximum interoperability with the various phones. Developed to comply with the VDE0834-1-2 standard, the nurse call system blends in perfectly in any kind of building.



To ensure maximum hygiene at all times, cover plates, devices and terminals in the Call-way system are available in an antibacterial version treated with silver ions. **Antibacterial treatment also for the Plana, Arké and Eikon series:** buttons in both white and anthracite grey and certain cover plate finishes can upon request be produced with the silver ion based treatment .



REDUCTION OF  
**90%**  
OF GROWTH OF BACTERIA



**Bars, cafés, restaurants, communal areas in apartment buildings and hotels, toilet facilities in theatres, museums and cinemas, as well as in retail outlets, chemist's schools and nursery schools:** these are just some examples of places where bacteria could spread due also to contact with and the use of lighting devices by more than one person.



CERTIFICATION FROM THE DEPARTMENT OF MOLECULAR MEDICINE OF PADOVA UNIVERSITY

Index

---

General introduction

**Smart products**

View Wireless

By-me Plus

Well-contact Plus

Call-way and antibacterial solutions

**Smart products**

Introduction	26
Typical systems	36
Quid	42
Smart Clima	43
Radiofrequency devices	44
Wi-Fi access point	48
Stand alone sound system	49
Video door entry system	51



## Smart products: devices that are quick to install and easy to use.

Smart solutions designed to increase the functions of conventional systems, minimising the work and labour required, like **Quid** devices to control lights and roller shutters or **Smart Climate Control** thermostats and timer-thermostats to manage the temperature in an easy and user-friendly way inside your home even remotely with the By-clima app. Or **radio frequency controls** which require no electrical power supply or batteries, and can be installed anywhere without the need for any masonry works. Or the **Wi-Fi access point** that can be used to improve building connectivity or the stand-alone **sound system** that uses Bluetooth® wireless technology to play music anywhere in the home from mobile devices. And last but not least the **video entryphones** with integrated Wi-Fi for remote control via the Video Door app.

### Quid



The evolution of the traditional system for controlling lights and roller shutters. A series of devices with simple and user-friendly installation that develops wired systems and offers a host of advantages.

### Smart Clima



Surface mounting thermostats and timer-thermostats to manage the temperature easily and completely both from inside your home and remotely with the By-clima app, installed on your smartphone.

### Radiofrequency devices



Wireless solutions for radio frequency light control. Battery-free and requiring no masonry work, they are based on the EnOcean, ZigBee protocols and Bluetooth® wireless technology. They incorporate an innovative control for operating Philips Hue lamps and luminaires.

### Wi-Fi Access point



To extend WLAN coverage to areas not covered by the Wi-Fi router. For traditional or home automation systems.

### Stand alone sound system



Listening to your favourite tunes while streaming directly from your smartphone or tablet is now much simpler thanks to the new devices equipped with Bluetooth® wireless technology, for both multiroom and stand-alone applications

### Video door entry system



Communicating with outside your home is even simpler and even smarter, thanks to the Tab 7S Up and Tab 5S Up video entryphones with integrated Wi-Fi for management via the Video Door app.

## Quid. Advanced traditional system for controlling lights and roller shutters.

Vimar's experience has put together new solutions with "something extra" dedicated to **controlling lights and roller shutters** in **traditional systems**. A range of devices with simple and user-friendly installation marks the development of wired systems and offers a host of advantages, such as centralised lights off and centralised control of roller shutters with load cut-off at the limit stop and saving of the favourite position.

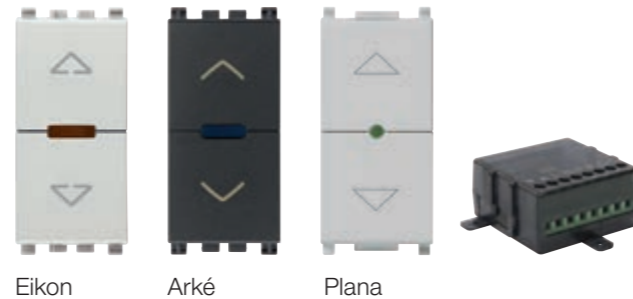

Eikon Arké Plana  
Electronic switches and devices for centralised control of roller shutters.

The innovative and reliable new switch supports advanced functions even on wired systems: offering you the chance to automate curtains or roller shutters by enabling their control in groups, with load cut-off at the limit stop and saving of the favourite position.

Innovative and more silent magnetic relay for controlling lights.

Combining the silent operation of traditional electronic devices with the reliability of electro-mechanical ones and introduces new advanced functions such as the possibility of centralising lights off. Moreover, it is not powered, an advantage that translates to energy savings and environmental friendliness.



## Smart Clima for simple temperature management.

Surface mounting thermostats and timer-thermostats fitted with user-friendly controls, some with extremely easy-to-read touch screens and others with push buttons. They allow for simple and comprehensive temperature control, whether you are at home or away, and display consumption levels to encourage energy saving. And what's more, with the timer-thermostat the boiler can be switched on and off with daily or weekly settings. With the user-friendly By-clima app, you can manage Wi-Fi and GSM devices remotely using your smartphone.





# Radio frequency controls.

Requiring no power supply or batteries, they can be mounted on any surface, even wood or glass. They work perfectly with the products of the major players in both the professional and consumer sectors that have adopted the **Bluetooth®** standard (Casambi and Xicato|Controls technologies) or **EnOcean** or **Zigbee** standard (Philips Hue system). The signal is transmitted by radio to a driver, actuator or gateway, without any wiring or masonry work as there is no need for flush mounting boxes. Ideal for renovations, redevelopments and updates, or any installations subject to regulatory or architectural constraints.



<p>control with <b>EnOcean®</b> protocol compatible with:</p> <ul style="list-style-type: none"> <li>• products that use EnOcean technology or EnOcean Equipment Profile (EEP) F6 02 01 (art. 03955).</li> </ul>	<p>control with <b>Zigbee®</b> protocol compatible with:</p> <ul style="list-style-type: none"> <li>• Philips <b>Hue</b> lamps (art. 03906);</li> <li>• Philips <b>EasyAir</b> sensors (art. 03905).</li> </ul>	<p>control with <b>Bluetooth® Low Energy</b> wireless technology compatible with:</p> <ul style="list-style-type: none"> <li>• lamps and systems based on Casambi technology and Bluetooth Open Standard technology from the Xicato Controls system displaying the logo "Works with Xicato Controls" (art. 03925).</li> </ul>
--	---	---



**Friends of Hue**  
 The technological expertise and impeccable design of Vimar are now teaming up with wireless technology for the smart control of Philips Hue lamps. The new controls are based on an Energy Harvesting technological motor and guarantee full control over wireless lamps via the Philips HUE Bridge (vers. 2.0), fully respecting the environment as they are battery-free.



## Wi-Fi Access Point for network signal extension.

The simplest solution for extending your Internet connection throughout your home, even to areas that are not reached by the Wi-Fi router signal or where the signal is weaker, providing coverage for all the environments thanks to a stylish product integrated into the wiring series. Indeed, the new 2-module Wi-Fi access point is designed to support data exchange in both wireless networks and copper and fiber optic cabled networks. Moreover, thanks to the front push button or a conventional remote push button connected to the rear terminals, the signal can be deactivated at any time when not needed or at night, to reduce electromagnetic waves and power consumption.



## Stand-alone sound system.



Thanks to Bluetooth® wireless technology, mini stand-alone systems can be created quickly and simply. This simple solution requires a Bluetooth receiver with integrated amplifier, a pair of speakers and a power supply. Your smartphone connects automatically so you can listen to your favourite music in the room. Other sound sources, such as the TV, can also be connected to the amplifier via cable. The ideal solution for all applications, from residential settings to small service industry companies such as accommodation facilities.



## Video door entry systems. Tab 7S Up and Tab 5S Up for total control, even when you are out and about.

The video entryphones in the Tab 7S Up and Tab 5S Up series, with their light-weight, stylish and understated design, provide a perfect image of what is going on outside the building thanks to the 7" and 5" monitors. In addition to conventional video door entry functions, they feature **integrated Wi-Fi** to allow you to manage your calls via the **Video Door app**. So if you're not home and the courier comes, you can speak to him and make arrangements for the delivery, or if you're in the garden or on the terrace, a simple tap on your smartphone will open the door to your guest. Moreover, they manage up to 5 different video door entry systems: for instance, your main home, your holiday home, the office and your relatives' homes too. And calls can be forwarded to up to 10 different users.



Tab 7S UP with integrated Wi-Fi



Tab 5S UP with integrated Wi-Fi



**Video Door app: multi-system, multi-lingual and multi-user.**

With a single app, you can manage up to 5 different video door entry systems, forward calls to up to 10 different users, choose between 8 language versions and manage and receive notifications from 5 different systems, with both Due Fili Plus and IP technology.



## Plenty of **solutions** and **advantages.**

### **QUID: DEVICES FOR CONTROLLING LIGHTS AND ROLLER SHUTTERS.**

The magnetic relay for **controlling lights** is more silent than electro-mechanical devices, allowing the centralised lights off of all the lights and it does not overheat because the current is not present after the change of state.

While the devices for **roller shutter control** offer the chance to automate the curtains or roller shutters by enabling their control in groups, with voltage cut-off at the limit stop and saving of the favourite position.



### **SMART CLIMA: CLIMATE CONTROL AT THE TOUCH OF AN APP**

By-clima, the user-friendly App for the remote control via smartphone or tablet of all the functions of Wi-Fi and GSM thermostats and timer-thermostats. A smart solution to have the desired temperature at all times and enjoy life enveloped by maximum comfort.



By-clima app

### **RADIO FREQUENCY CONTROLS: WIRELESS AND BATTERY-FREE.**

The signal is transmitted via radio to the driver, actuator or bridge, with no need for cable connections. The working frequency (very low power emitted when the button is pressed) for EnOcean is 868 MHz, and for ZigBee and Bluetooth it is 2.4 GHz. It is self-powered by the energy produced when pressing the keys, with no need for batteries. Periodic maintenance to change the batteries is therefore not required, thus avoiding their disposal and respecting the environment.

### **RADIO FREQUENCY CONTROLS: VERSATILE INSTALLATION WITHOUT ANY MASONRY WORK.**

The radio frequency control can be placed on any surface, such as glass, wood or on the wall. It is extremely easy to install, with no need to break down or repaint walls. It can be quickly applied to the wall, since it does not require flush mounting boxes. It is the ideal solution for moving 1-way switches in case of partial renovations.



### **RADIO FREQUENCY CONTROLS. LIGHTING SCENARIOS.**

The lighting scenarios and behaviour of each key can easily be managed from a smartphone to: call up scenarios, switch the lights on and off, adjust the brightness or change the colour of RGB lamps. These functions can all be configured via the control App of the manufacturers of any lamps that are compatible with the different technologies.

### **RADIO FREQUENCY CONTROLS. FLAT CONTROL WITH FOUR PUSH BUTTONS.**

Flat control with battery-free radio frequency transmitter and power supply provided by the built-in electro-dynamic generator. Each control consists of 4 push buttons which can be configured individually or in pairs according to the features of the associated receivers. Simply press the keys to switch On/Off, adjust the light brightness or call up coloured or monochrome lighting scenarios.

### **ACCESS POINT: MORE NETWORK SIGNAL COVERAGE AND SWITCH FUNCTION.**

Extends the Wi-Fi network coverage to all rooms, even covering areas that are not reached by the Wi-Fi router. Ideal for retrofitting existing systems: all that is required is a round mounting box or 3 modules with a socket outlet, which will need replacing.

In addition to Wi-Fi connectivity, the device also has a double Ethernet cable port on the back, for extending the LAN network.



### **SOUND SYSTEM: BLUETOOTH® WIRELESS TECHNOLOGY.**

Thanks to this innovative technology, wired connections are no longer necessary, simply activate the Bluetooth on your smartphone, the connection is made automatically and the music plays throughout the rooms. In addition, the Bluetooth receiver with built-in amplifier is designed to add limitless local sound sources.



### **VIDEO DOOR ENTRY SYSTEMS.**

Video entryphones with integrated Wi-Fi allowing you to manage your calls via the Video Door App, supporting multiple functions remotely too: opening the entrance gate, making intercom calls between two video entryphones in the same building or from and to a mobile device, viewing the images of the cameras associated with the system or activating multiple auxiliary functions. In addition, the video entryphones are multi-system and multi-user.



Typical system: 90 m<sup>2</sup> apartment with EnOcean radio frequency controls for controlling lights and Wi-Fi router.



The **EnOcean** radio frequency devices are ideal for adding control and actuation functions to new or existing systems, with no need for any masonry work. In **new systems**, for applications on materials that would make installation difficult, if not impossible, with flush mounting boxes (glass, wood, reinforced concrete) or on structures that have to be left intact in order to maintain the thermal insulation required in modern buildings. In **existing systems**, due to lack of arrangements or due to the architectural constraints of historic buildings.

- Benefits offered by Vimar devices with **EnOcean technology**:
- no radio interference in reception or in transmission, thanks to the robust protocol and low electromagnetic emissions (the lowest of all the radio technologies currently available on the market);
  - no maintenance is required on the controls to replace the batteries: the controls work without batteries, using the energy generated by pressing the key;
  - each single control is designed to govern two different independent electrical loads;
  - aesthetic coordination of the controls with Eikon, Arké and Plana;
  - can be installed on smooth surfaces with the special mounting frames, or in flush mounting boxes on standard mounting frames;

- the actuator can also act as a repeater by receiving the signal from the control and transmitting it to a second actuator on which it is configured;
- the actuator can also work as a switch for a mixed wired and radio frequency system.

The example illustrates EnOcean devices installed in an apartment, where it is possible to switch loads On/Off, with 03955 controls and 01796.2 actuators:

- a single control at the entrance is used to manage the three lights in the living room, kitchen and hallway, thus creating Entry and Exit scenarios. In fact, the actuator in the living room is also configured as a signal repeater for the actuator in the kitchen, and this in turn, as a repeater for the actuator in the hallway;
- the Wi-Fi router in the bedroom is activated using a radio frequency control above the desk, while the flush mounting one installed in the lounge is switched on or off from a clean contact push button;
- in the bedroom, the light is managed by two junction boxes, an inverter and an EnOcean radio frequency control integrated into the wired system;
- there is also a control installed in the bedroom, which communicates with the EnOcean actuator to activate the LED strip inside the walk-in wardrobe.

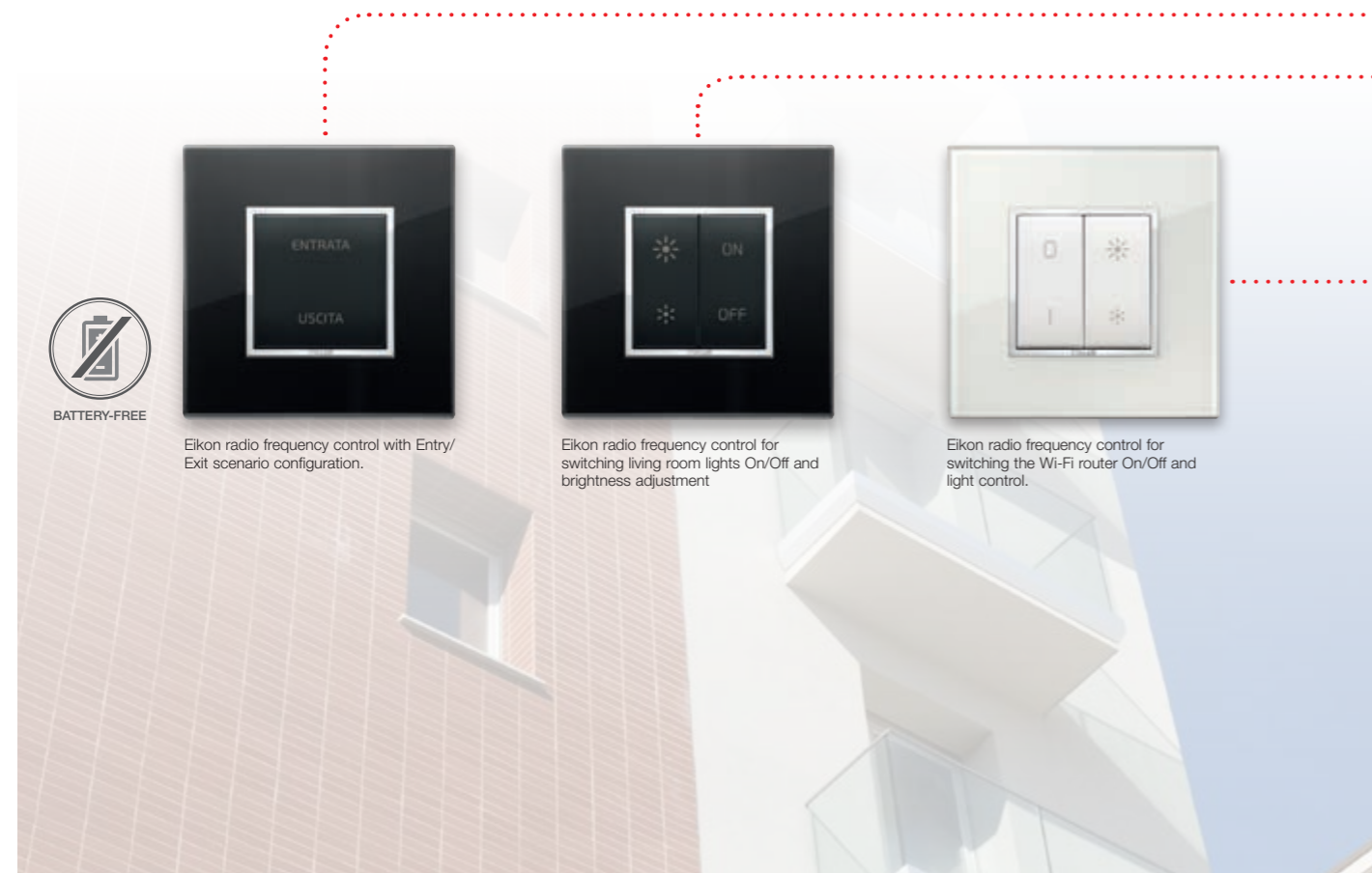

Typical system: 90 m<sup>2</sup> apartment with EnOcean radio frequency controls for controlling lights and Wi-Fi router.

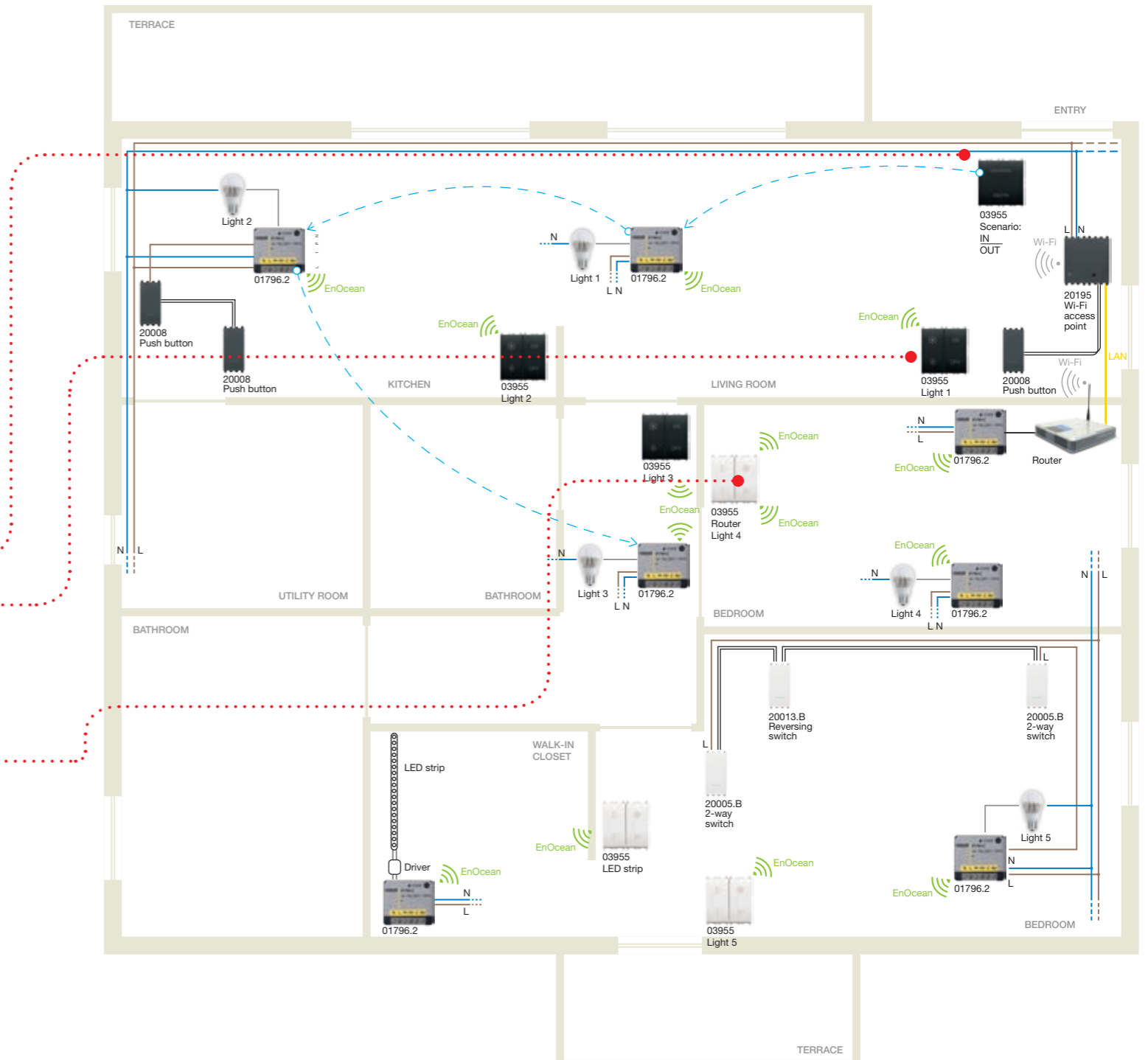

## Typical system: bed&breakfast with Wi-Fi internet connection in every room.

Vimar offers the easiest solution for bringing Internet connectivity to the whole facility, even where it doesn't reach or where the Wi-Fi router signal is weak, guaranteeing coverage in all the environments thanks to the flush-mounting Wi-Fi access point that supports data exchange in both wireless and copper or fiber optic networks.

The example shows a B&B with 6 guest rooms, a dining room and foyer/reception area. The Wi-Fi router is installed in the reception, connected to the Internet, with flush-mounting Wi-Fi access points in all the rooms

to guarantee the web connection via mobile devices (PC, tablet or smartphone) to guests.

The Wi-Fi access points (art. 14195) are connected to the main router via a LAN network and powered at 230 V~.

In the dining room the access point is not connected by cable to the LAN network, but only to the power supply, and acts as a repeater, taking the Wi-Fi signal directly from the router.

A front push button on the device is used to deactivate the signal, when not needed or at night, to reduce radiation and consumption.



Typical system: bed&breakfast with Wi-Fi internet connection in every room.

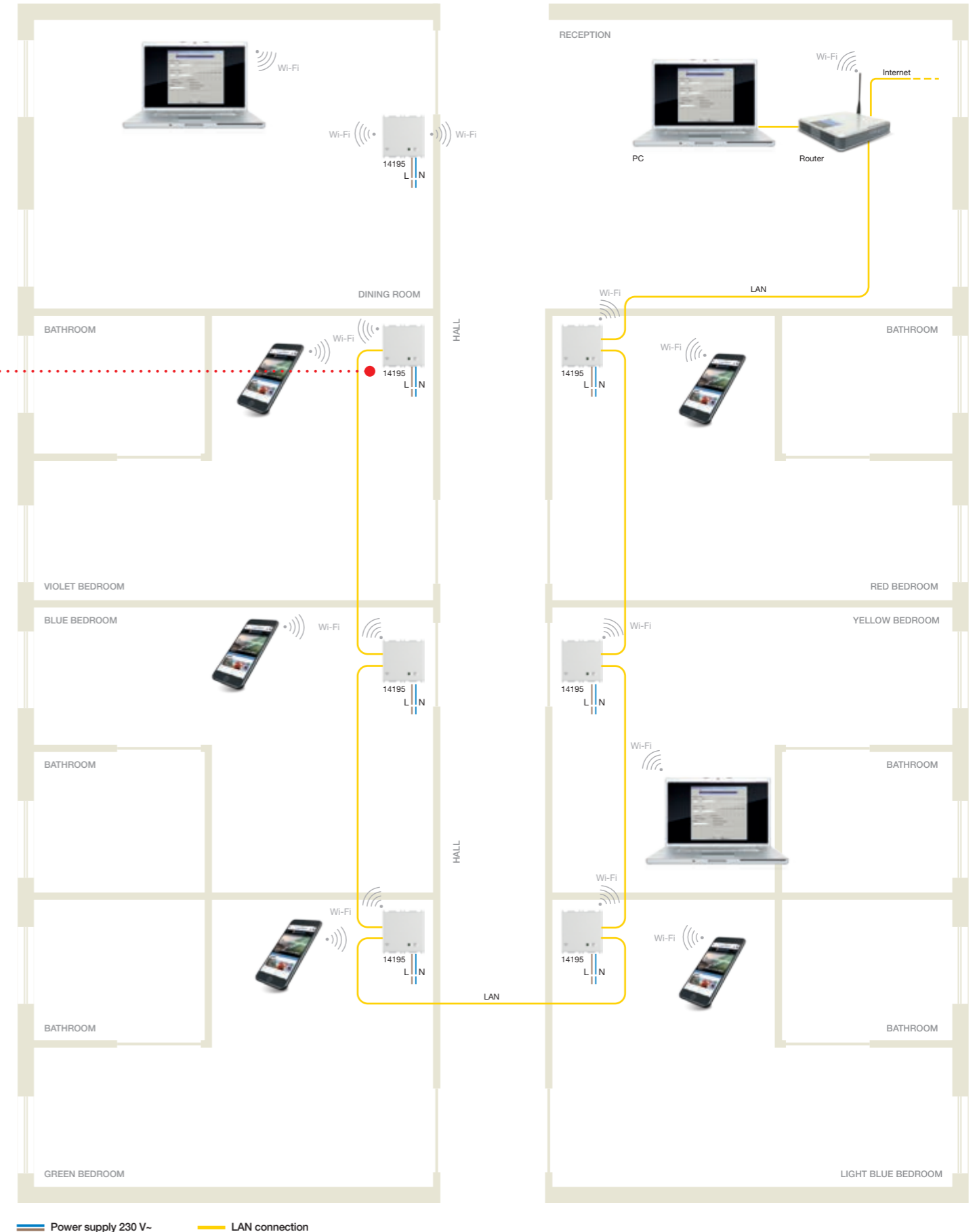

## Typical system: 160 m<sup>2</sup> villa with stand-alone sound system.



Thanks to Bluetooth® technology, mini stand-alone systems can be created quickly and simply. This simple solution requires a Bluetooth receiver with integrated amplifier, a pair of speakers and a power supply. Your smartphone connects automatically so you can listen to your favourite music in the room. Other sound sources, such as the TV, can also be connected to the amplifier via cable. The ideal solution for all applications, from residential settings to small service companies and particularly accommodation facilities. For flush mounting devices, interface and stereo amplifier, the Bluetooth network name can also be customised.

In the example 6 stereo amplifiers (art. 19590.B) 4+4 W RMS with built-in Bluetooth receiver are installed (in the kitchen,

lounge, the three bedrooms and the bathroom), powered at 12 V with power supply for DIN rail (art. 01831.1) installed in the utility room.

The amplifiers are connected to passive flush mounting speakers, 8 Ω 3 W (art. 20587.B) in the kitchen, bathroom and two bedrooms, while in the lounge and the double room the most powerful flush mounting speakers, 8 Ω 10 W with 8 modules (art. 21588.B) are connected.

Moreover in the lounge, the Hi-Fi system amplifier is connected to the input of the flush-mounting amplifier 19590.B to play music in the room from the radio, CD or TV, thus creating a home theatre effect.

## Typical system: 160 m<sup>2</sup> villa with stand-alone sound system.

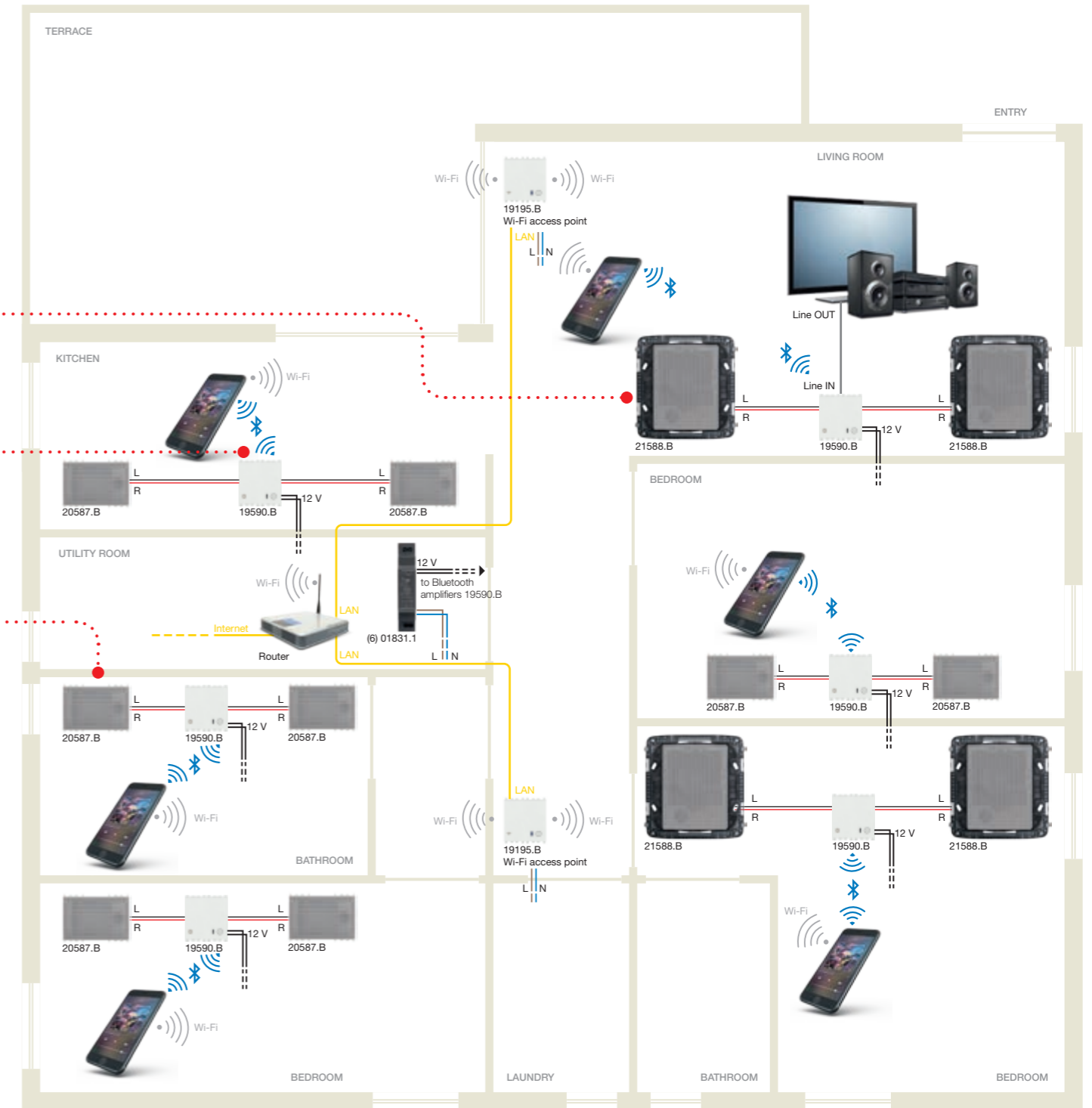

— Power supply 230 V-      — Power supply 12 V (power supplies 01831.1)      — Wired connection to sound system (Right/Left)

The diagrams are provided by way of example only. For details on the correct dimensions of the system, refer to the installation manual.



Sound system with 8 modules 8 Ω 10 W RMS.





Stereo amplifier 8 Ω 4+4 W RMS with built-in Bluetooth receiver.

Sound system with 3 modules 8 Ω 3 W RMS.

EIKON ARKÉ PLANA

Quid

Magnetic relay module for lighting (backfit)

 <b>03991</b> ON/OFF sequence pulse relay module, 1 input for NO push button, 1 NO 10 A 220-240 V~ 50/60 Hz relay output, for backfit	 <b>03992</b> ON/OFF sequence pulse relay module, 1 input for NO push button, 1 input for reset push button, 1 NO 10 A 220-240 V~ 50/60 Hz relay output, luminous signalling of load status, for backfit	 <b>03993</b> ON/OFF sequence pulse relay module, 1 input for NO push button, 2 NO 10 A 220-240 V~ 50/60 Hz sequence relay outputs, for backfit	 <b>00932</b> Load status LED signalling unit, pre-wired for Quid pulse relay module with pulse control push buttons 03992, 220-240 V 50/60 Hz 0,5 W power supply, green
---	---	--	---

Electronic 2-way switch for roller shutter

 <b>20196</b> Slat orientation with relay outputs for cosφ 0,6 motor 2 A 220-240 V~ 50/60 Hz, position saving, grey. Depth: 41,5 mm	 <b>20196.B</b> Slat orientation with relay outputs for cosφ 0,6 motor 2 A 220-240 V~ 50/60 Hz, position saving, white. Depth: 41,5 mm	 <b>19196</b> Slat orientation with relay outputs for cosφ 0,6 motor 2 A 220-240 V~ 50/60 Hz, position saving, grey. Depth: 40,5 mm	 <b>19196.B</b> Slat orientation with relay outputs for cosφ 0,6 motor 2 A 220-240 V~ 50/60 Hz, position saving, white. Depth: 40,5 mm	 <b>14196</b> Slat orientation with relay outputs for cosφ 0,6 motor 2 A 220-240 V~ 50/60 Hz, position saving, white. Depth: 40,5 mm	 <b>14196.SL</b> Slat orientation with relay outputs for cosφ 0,6 motor 2 A 220-240 V~ 50/60 Hz, position saving, Silver. Depth: 40,5 mm
 <b>20196.N</b> Slat orientation with relay outputs for cosφ 0,6 motor 2 A 220-240 V~ 50/60 Hz, position saving, Next. Depth: 41,5 mm	 <b>19196.M</b> Slat orientation with relay outputs for cosφ 0,6 motor 2 A 220-240 V~ 50/60 Hz, position saving, Metal. Depth: 40,5 mm				

Electronic relay module and control unit module for roller shutters (backfit)

 <b>03996</b> Centralizable relay module, slat orientation, with relay outputs for cosφ 0,6 motor 2 A 220-240 V~ 50/60 Hz, position saving, for backfit or junction boxes installation	 <b>03997</b> Control unit module, 2 inputs for NO push button, 6 outputs for Quid roller shutter relay module (03996), 220-240 V~ 50/60 Hz power supply, for backfit or junction boxes installation
--	---



Smart Clima

Wi-Fi and GSM surface mounting timer-thermostats and thermostats



 <b>01913</b> ClimaPhone timer-thermostat for local or remote ON/OFF control (via SMS or dedicated app) of the ambient temperature (heating and air-conditioning) with built-in GSM phone dialler, daily/weekly programming, class I temperature control device (contribution 1%), change-over relay output 5(2) A 230 V~, an additional output and a digital input, 120-230 V~, surface mounting, white. Dimensions: 130x90x35,5 mm	 <b>01913.14</b> ClimaPhone timer-thermostat for local or remote ON/OFF control (via SMS or dedicated app) of the ambient temperature (heating and air-conditioning) with built-in GSM phone dialler, daily/weekly programming, class I temperature control device (contribution 1%), change-over relay output 5(2) A 230 V~, an additional output and a digital input, 120-230 V~, surface mounting, anthracite grey. Dimensions: 130x90x35,5 mm
---	--

 <b>02907</b> ClimaThermo Wi-Fi touch screen thermostat for local or remote control (with dedicated app) of temperature (heating and air-conditioning) in ON/OFF and PID modes, class I temperature control device (contribution 1%) in ON/OFF mode, class IV (contribution 2%) in PID mode, 1 input for external temperature sensor, change-over relay output 5(2) A 230 V~, 230 V~ 50/60 Hz, white LED backlighting, surface mounting, white. Dimensions: 135x95x25,2 mm	 <b>02906</b> ClimaThermo touch screen thermostat with built-in GSM for local or remote control (with dedicated app) of ambient temperature (heating and air-conditioning), class I temperature control device (contribution 1%) in ON/OFF mode, class IV (contribution 2%) in PID mode, 1 input for external temperature sensor, change-over relay output 5(2) A 230 V~, 230 V~ 50/60 Hz, white LED backlighting, surface mounting, white. Dimensions: 135x95x25,1 mm
---	---

Surface mounting timer-thermostats and thermostats

 <b>02910</b> ClimaChrono touch screen timer-thermostat for ambient temperature control (heating and air-conditioning), designed to display energy data via an energy meter, class I temperature control device (contribution 1%) in ON/OFF mode, class IV (contribution 2%) in PID mode, 1 programmable multifunction input, 5(2) A 230 V~ change-over relay output, AA LR6 1,5 V battery-powered (not supplied), surface mounting, white. Dimensions: 135x95x25,1 mm	 <b>01911</b> ClimaPiù sliding timer-thermostat for ON/OFF ambient temperature control (heating and air-conditioning), class I temperature control device (contribution 1%), change-over relay output 5(2) A 250 V~, AA LR6 1,5 V battery-powered (not supplied), surface mounting, white. Dimensions: 131,85x89,9x32,1 mm
---	---

 <b>01910</b> ClimaRadio timer-thermostat for ON/OFF ambient temperature control (heating and air-conditioning), daily/weekly programming, class I temperature control device (contribution 1%), change-over relay output 5(2) A 250 V~, AA LR6 1,5 V battery-powered (not supplied), surface mounting, white. Dimensions: 130x90x22 mm	 <b>01910.14</b> ClimaRadio timer-thermostat for ON/OFF ambient temperature control (heating and air-conditioning), daily/weekly programming, class I temperature control device (contribution 1%), change-over relay output 5(2) A 250 V~, AA LR6 1,5 V battery-powered (not supplied), surface mounting, anthracite grey. Dimensions: 130x90x22 mm	 <b>01910.20</b> ClimaRadio timer-thermostat for ON/OFF ambient temperature control (heating and air-conditioning), daily/weekly programming, class I temperature control device (contribution 1%), change-over relay output 5(2) A 250 V~, AA LR6 1,5 V battery-powered (not supplied), surface mounting, Silver. Dimensions: 130x90x22 mm
--	---	--

 <b>02905</b> ClimaThermo touch screen thermostat for ambient temperature control (heating and air-conditioning), class I temperature control device (contribution 1%) in ON/OFF mode, class IV (contribution 2%) in PID mode, 1 programmable multifunction input, change-over relay output 5(2) A 230 V~, 2 AA LR6 1,5 V battery-powered (not supplied), surface mounting, white. Dimensions: 135x95x21 mm	 <b>02900.1</b> Clima thermostat for ON/OFF ambient temperature control (heating and air-conditioning), class I temperature control device (contribution 1%), change-over relay output 5(2) A 240 V~, AA LR6 1,5 V battery-powered (not supplied), surface mounting, white. Dimensions: 132x87x27 mm
--	---

Radiofrequency devices



**03955**  
4-button flat device with RF transmission, 868 MHz, **EnOcean**® standard, energy harvesting supply powered by built-in electrodynamic generator, to complete with 20506 or 20506.2, 19506 or 19506.2, 16526 o 16526.2, 14506 or 14506.2 buttons - 2 modules



**01796.2**  
Multi-function actuator with relay output NO 10 A 230 V~ programmable with switch function for local control, transferable local input as ON/OFF control for other **EnOcean**® actuators, 230 V~ 50/60 Hz power supply



Compatible with **View Wireless** system

**03925**  
4-button flat device with RF transmission, 2.4 GHz, **Bluetooth**® Low Energy *wireless technology* standard, energy harvesting supply powered by built-in electrodynamic generator, to complete with 20506 or 20506.2, 19506 or 19506.2, 16526 o 16526.2, 14506 or 14506.2 buttons - 2 modules



**03905**  
4-button flat device with RF transmission, 2.4 GHz, **Zigbee Green Power** standard, energy harvesting supply powered by built-in electrodynamic generator, to complete with 20506 or 20506.2, 19506 or 19506.2, 16526 o 16526.2, 14506 or 14506.2 buttons - 2 modules



**03906**  
4-button flat device with RF transmission, 2.4 GHz, **Zigbee Green Power** and **Friends of Hue** standard, energy harvesting supply powered by built-in electrodynamic generator, to complete with 20506, 19506, 16526 or 14506 buttons - 2 modules

EIKON

ARKÉ

IDEA

PLANA

Radiofrequency devices

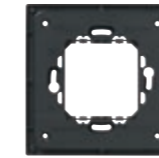

**21507.1**  
Frame for Eikon Evo 2-module cover plates, grey

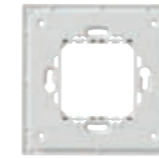

**21507.1.B**  
Frame for Eikon Evo 2-module cover plates, white

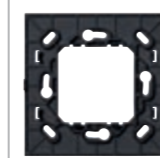

**19507.CL**  
Frame for Arké Classic 2-module cover plates, grey

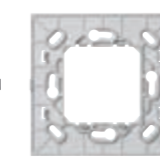

**19507.CL.B**  
Frame for Arké Classic 2-module cover plates, white

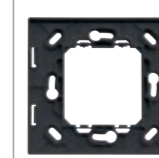

**16527.CL**  
Frame for Idea Classic 2-module cover plates, grey

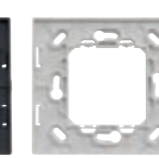

**16527.CL.B**  
Frame for Idea Classic 2-module cover plates, white

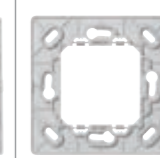

**14507**  
Frame for Plana 2-module cover plates, white



**22507**  
Frame for Eikon Exé 2-module cover plates, grey



**22507.B**  
Frame for Eikon Exé 2-module cover plates, white



**19507.RN**  
Frame for Arké Round 2-module cover plates, grey



**19507.RN.B**  
Frame for Arké Round 2-module cover plates, white

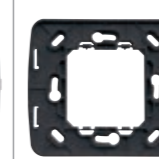

**16527.RN**  
Frame for Idea Rondò 2-module cover plates, grey

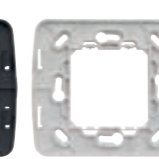

**16527.RN.B**  
Frame for Idea Rondò 2-module cover plates, white

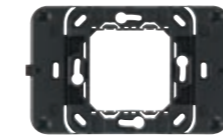

**20507**  
Frame for Eikon 2-central-module or 2-module cover plates, grey



**19507**  
Frame for Arké 2-central-module or 2-module cover plates, grey



**20507**  
Frame for Plana 2-central-module or 2-module cover plates, grey



**20507.B**  
Frame for Eikon 2-central-module or 2-module cover plates, white



**19507.B**  
Frame for Arké 2-central-module or 2-module cover plates, white



**20507.B**  
Frame for Plana 2-central-module or 2-module cover plates, white



EIKON      ARKÉ      IDEA      PLANA

Radiofrequency devices

<b>20506</b> Pair of 1-module buttons for RF devices, customisable <sup>1</sup> , grey	<b>20506.B</b> Pair of 1-module buttons for RF devices, customisable <sup>1</sup> , white	<b>19506</b> Pair of 1-module buttons for RF devices, customisable <sup>1</sup> , grey	<b>19506.B</b> Pair of 1-module buttons for RF devices, customisable <sup>1</sup> , white	<b>16526</b> Pair of 1-module buttons for RF devices, customisable <sup>1</sup> , grey	<b>16526.B</b> Pair of 1-module buttons for RF devices, customisable <sup>1</sup> , white	<b>14506</b> Pair of 1-module buttons for RF devices, customisable <sup>1</sup> , white	<b>14506.SL</b> Pair of 1-module buttons for RF devices, customisable <sup>1</sup> , Silver
<b>20506.N</b> Pair of 1-module buttons for RF devices, customisable <sup>1</sup> , Next		<b>19506.M</b> Pair of 1-module buttons for RF devices, customisable <sup>1</sup> , Metal					
<b>20506.2</b> 2-module button for RF devices, customisable <sup>1</sup> , grey	<b>20506.2.B</b> 2-module button for RF devices, customisable <sup>1</sup> , white	<b>19506.2</b> 2-module button for RF devices, customisable <sup>1</sup> , grey	<b>19506.2.B</b> 2-module button for RF devices, customisable <sup>1</sup> , white	<b>16526.2</b> 2-module button for RF devices, customisable <sup>1</sup> , grey	<b>16526.2.B</b> 2-module button for RF devices, customisable <sup>1</sup> , white	<b>14506.2</b> 2-module button for RF devices, customisable <sup>1</sup> , white	<b>14506.2.SL</b> 2-module button for RF devices, customisable <sup>1</sup> , Silver
<b>20506.2.N</b> 2-module button for RF devices, customisable <sup>1</sup> , Next		<b>19506.2.M</b> 2-module button for RF devices, customisable <sup>1</sup> , Metal					

Radiofrequency kits

**OK03906.03**  
Kit Friends of Hue Eikon Evo. Contains:  
• 1 4-button RF device 03906  
• 1 mounting frame 21507.B, white  
• 2 buttons 20506.B, white  
• 2-module cover plate 21642.17, total white

EIKON      ARKÉ      PLANA

Radiofrequency kits

<b>OK03906.05</b> Kit Friends of Hue Arké Classic. Contains: • 1 4-button RF device 03906 • 1 mounting frame 19507.CL.B, white • 2 buttons 19506.B, white • 2-module cover plate 19642.B66, Reflex Ice total look	<b>OK03906.06</b> Kit Friends of Hue Arké Round. Contains: • 1 4-button RF device 03906 • 1 mounting frame 19507.RN.B, white • 2 buttons 19506.B, white • 2-module cover plate 19672.B66, Reflex Ice total look	<b>OK03906.07</b> Kit Friends of Hue Arké Classic. Contains: • 1 4-button RF device 03906 • 1 mounting frame 19507.CL, grey • 2 buttons 19506, grey • 2-module cover plate 19642.71, Black	<b>OK03906.08</b> Kit Friends of Hue Arké Round. Contains: • 1 4-button RF device 03906 • 1 mounting frame 19507.RN, grey • 2 buttons 19506, grey • 2-module cover plate 19672.81, Black	<b>OK03906.04</b> Kit Friends of Hue Plana. Contains: • 1 4-button RF device 03906 • 1 mounting frame 14507, white • 2 buttons 14506, white • 1 2-module cover plate 14642.01, white

EIKON ARKÉ PLANA

Wi-Fi access point



**20195**  
Wi-Fi 72.2 Mb/s access point with 2 10-100 Mb/s LAN ports, input for remote Wi-Fi radio on/off push button, supply voltage 230 V~50/60 Hz, grey - 2 modules. Depth: 41 mm



**19195**  
Wi-Fi 72.2 Mb/s access point with 2 10-100 Mb/s LAN ports, input for remote Wi-Fi radio on/off push button, supply voltage 230 V~50/60 Hz, grey - 2 modules. Depth: 40,7 mm



**14195**  
Wi-Fi 72.2 Mb/s access point with 2 10-100 Mb/s LAN ports, input for remote Wi-Fi radio on/off push button, supply voltage 230 V~50/60 Hz, white - 2 modules. Depth: 40 mm



**20195.B**  
Wi-Fi 72.2 Mb/s access point with 2 10-100 Mb/s LAN ports, input for remote Wi-Fi radio on/off push button, supply voltage 230 V~50/60 Hz, white - 2 modules. Depth: 41 mm



**19195.B**  
Wi-Fi 72.2 Mb/s access point with 2 10-100 Mb/s LAN ports, input for remote Wi-Fi radio on/off push button, supply voltage 230 V~50/60 Hz, white - 2 modules. Depth: 40,7 mm



**14195.SL**  
Wi-Fi 72.2 Mb/s access point with 2 10-100 Mb/s LAN ports, input for remote Wi-Fi radio on/off push button, supply voltage 230 V~50/60 Hz, Silver - 2 modules. Depth: 40 mm



**20195.N**  
Wi-Fi 72.2 Mb/s access point with 2 10-100 Mb/s LAN ports, input for remote Wi-Fi radio on/off push button, supply voltage 230 V~50/60 Hz, Next - 2 modules. Depth: 41 mm



**19195.M**  
Wi-Fi 72.2 Mb/s access point with 2 10-100 Mb/s LAN ports, input for remote Wi-Fi radio on/off push button, supply voltage 230 V~50/60 Hz, Metal - 2 modules. Depth: 40,7 mm

EIKON ARKÉ PLANA

Stand alone sound system



**20590<sup>1</sup>**  
4+4 W RMS stereo amplifier, 2 outputs for 8 Ω sound diffusers with built-in Bluetooth® wireless technology receiver, 1 LINE IN input, 12 Vdc, grey - 2 modules. Depth: 36 mm



**19590<sup>1</sup>**  
4+4 W RMS stereo amplifier, 2 outputs for 8 Ω sound diffusers with built-in Bluetooth® wireless technology receiver, 1 LINE IN input, 12 Vdc, grey - 2 modules. Depth: 36,7 mm



**14590<sup>1</sup>**  
4+4 W RMS stereo amplifier, 2 outputs for 8 Ω sound diffusers with built-in Bluetooth® wireless technology receiver, 1 LINE IN input, 12 Vdc, white - 2 modules. Depth: 36 mm



**20590.B<sup>1</sup>**  
4+4 W RMS stereo amplifier, 2 outputs for 8 Ω sound diffusers with built-in Bluetooth® wireless technology receiver, 1 LINE IN input, 12 Vdc, white - 2 modules. Depth: 36 mm



**19590.B<sup>1</sup>**  
4+4 W RMS stereo amplifier, 2 outputs for 8 Ω sound diffusers with built-in Bluetooth® wireless technology receiver, 1 LINE IN input, 12 Vdc, white - 2 modules. Depth: 36,7 mm



**14590.SL<sup>1</sup>**  
4+4 W RMS stereo amplifier, 2 outputs for 8 Ω sound diffusers with built-in Bluetooth® wireless technology receiver, 1 LINE IN input, 12 Vdc, Silver - 2 modules. Depth: 36 mm



**20590.N<sup>1</sup>**  
4+4 W RMS stereo amplifier, 2 outputs for 8 Ω sound diffusers with built-in Bluetooth® wireless technology receiver, 1 LINE IN input, 12 Vdc, Next - 2 modules. Depth: 36 mm



**19590.M<sup>1</sup>**  
4+4 W RMS stereo amplifier, 2 outputs for 8 Ω sound diffusers with built-in Bluetooth® wireless technology receiver, 1 LINE IN input, 12 Vdc, Metal - 2 modules. Depth: 36,7 mm



<sup>1</sup> The article can be ordered with Bluetooth network customisation (see specifications on page 183)



**01831.1**  
Supply unit 12 Vdc 1250 mA output, 100-240 V~ 50/60 Hz, 1 x 17,5 mm module



**20583**  
Spring connector for speaker, grey. Depth: 19,4 mm



**20583.B**  
Spring connector for speaker, white. Depth: 19,4 mm



**20583.N**  
Spring connector for speaker, Next. Depth: 19,4 mm



**19583**  
Spring connector for speaker, grey. Depth: 18,9 mm



**19583.B**  
Spring connector for speaker, white. Depth: 18,9 mm



**19583.M**  
Spring connector for speaker, Metal. Depth: 18,9 mm



**14583**  
Spring connector for speaker, white. Depth: 18,4 mm



**14583.SL**  
Spring connector for speaker, Silver. Depth: 18,4 mm

Stand alone sound system

Diffusers



**21588**  
Passive speaker 8 Ω 10 W, to complete with Eikon Evo, Eikon, Arké or Plana cover plates, grey. - 8 modules. Depth: 48 mm



**21588.B**  
Passive speaker 8 Ω 10 W, to complete with Eikon Evo, Eikon, Arké or Plana cover plates, white. - 8 modules. Depth: 48 mm



**21588.N**  
Passive speaker 8 Ω 10 W, to complete with Eikon Evo, Eikon, Arké or Plana cover plates, Next. - 8 modules. Depth: 48 mm



**20587**  
Passive speaker 3 Ω 10 W, to complete with Eikon Evo, Eikon, Arké or Plana cover plates, grey. - 3 modules. Depth: 40 mm



**20587.B**  
Passive speaker 3 Ω 10 W, to complete with Eikon Evo, Eikon, Arké or Plana cover plates, white. - 3 modules. Depth: 40 mm



**20587.N**  
Passive speaker 3 Ω 10 W, to complete with Eikon Evo, Eikon, Arké or Plana cover plates, Next. - 3 modules. Depth: 40 mm



**01906**  
IP55 passive speaker, 8 Ω 30 W, for hollow walls and false ceiling installation. Depth: 70 mm



**01907.1**  
Passive speaker, 8 Ω 30 W, for hollow walls and false ceiling installation. Depth: 68 mm



**01908**  
Passive speaker, 8 Ω 30 W, orientable, for surface mounting

Video door entry system

Due Fili Plus video entryphones



**▲ 40517**  
Tab 7S Up - surface mounting hands-free video entryphone, integrated Wi-Fi, 7" LCD display, teleloop facility for hearing aids, white



**40515**  
Tab 5S Up - surface mounting hands-free video entryphone, integrated Wi-Fi, 5" LCD display, teleloop facility for hearing aids, white

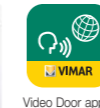

Accessories



**▲ 40596**  
Table box for Tab 7S Up video entryphone



**40595**  
Table box for Tab 5S Up video entryphone

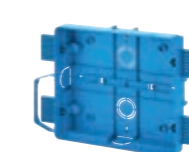

**▲ 40591**  
Flush mounting box for Tab 7S Up video entryphone for hollow walls and masonry

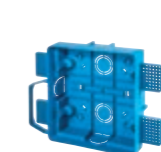

**40590**  
Flush mounting box for Tab 5S Up video entryphone for hollow walls and masonry

1-family pre-programmed video entry system kits



**▲ K40517.E**  
Kit comprises:  
- 1 series 1300/E flush mounting or surface mounting anodised aluminium entrance panel (40151);  
- 1 audio/video electronic unit (40135);  
- 1 Tab 7S Up hands-free video entryphone, white with integrated Wi-Fi for the remote control of the call on smartphone (40517);  
- 1 supply unit (6922.1)



**K40515.E**  
Kit comprises:  
- 1 series 1300/E flush mounting or surface mounting anodised aluminium entrance panel (40151);  
- 1 audio/video electronic unit (40135);  
- 1 Tab 5S Up hands-free video entryphone, white with integrated Wi-Fi for the remote control of the call on smartphone (40515);  
- 1 supply unit (6922.1)

Index

General introduction

Smart products

**View Wireless**

By-me Plus

Well-contact Plus

Call-way and antibacterial solutions

**View Wireless**

Introduction	54
Typical systems	68
Gateway	74
Connected voice controls	74
Connected 2-way switches	75
Connected controls for roller shutters	79
Connected socket outlet actuators	80
Connected thermostats	81
Connected energy meter	82
Connected access control	82

I am leaving.  
Turn  
everything  
off scenario.



## View Wireless smart home: make your system **connected**.

The View Wireless system is designed to **manage lighting in environments, roller shutters or motorised curtains, and also the temperature, to control accesses, monitor energy consumption and set scenarios** with the utmost simplicity using **classic 1-way switches, via App or directly by voice**. View Wireless is **ideal for renovations** or to **boost the functions of an existing** system, and it is a **useful means** of support for the elderly and people with restricted mobility. Make your building connected. The battery-free and wireless controls make it possible to add control points in complete freedom at any time.



Bluetooth®

Wi Fi®

zigbee



# Update your space simply.

Update, extend or replace your wiring system: you can create a connected system, suitable for any architectural context, thanks to the completely matching styling of the digital products and their easy functional expandability. Simply replace traditional 1-way switches in the existing system with new digital devices by Vimar and power them: 2-way switches, roller shutter and curtain actuators, actuators for connected socket outlets, equipped with Bluetooth® and Zigbee® technology.

**JUST A FEW TASKS. NO MASONRY WORK REQUIRED. IT IS VERSATILE. NEW SYSTEM, SAME SHAPE.**

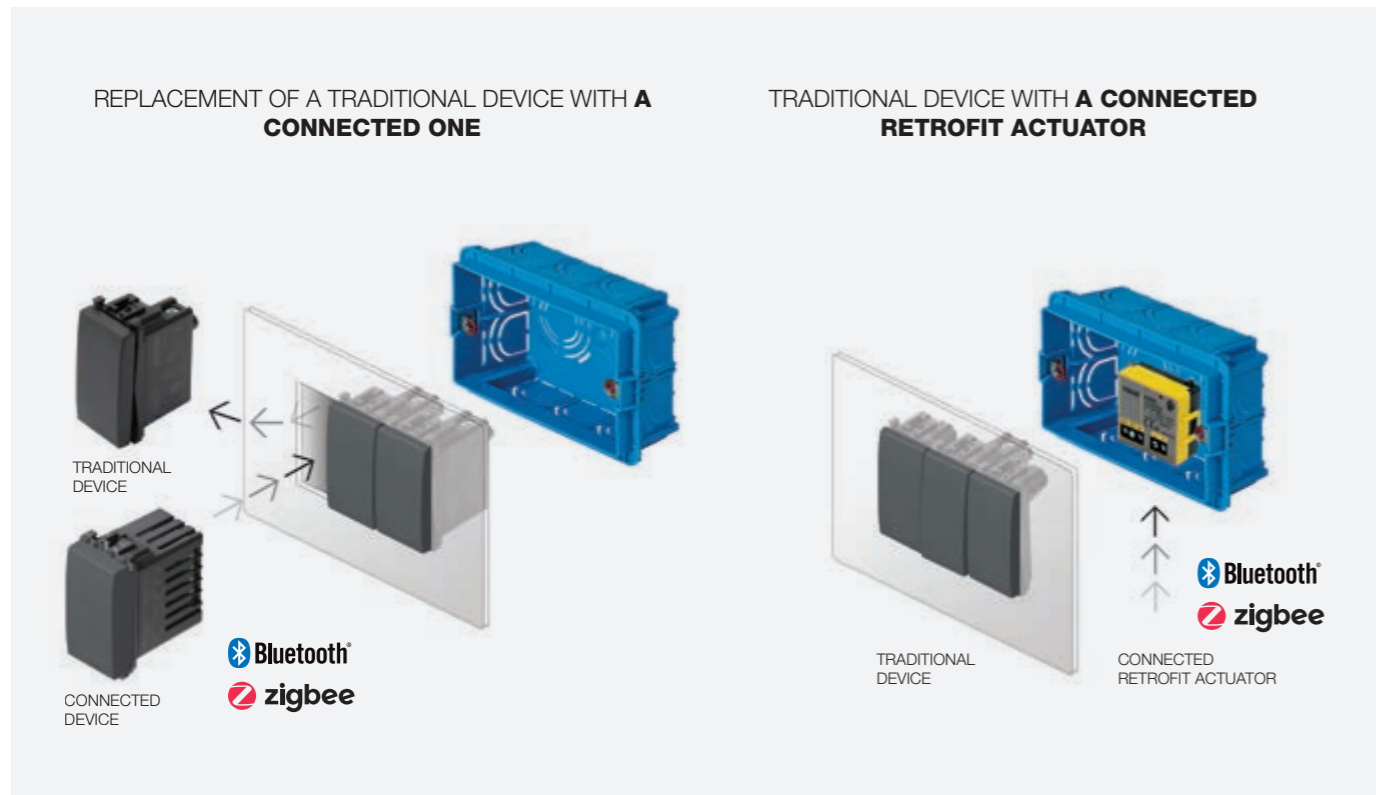

RENOVATION

SYSTEM UPDATE

NEW BUILDING

# Make your system connected.

View Wireless is the ideal solution when **renovating** an area of the home or an entire dwelling, store, restaurant, office and in those situations **where masonry work** and **repainting tasks** need to be kept to a minimum. Make your building connected. The battery-free and wireless controls make it possible to add control points in complete freedom at any time.

## TRADITIONAL WIRING SYSTEM

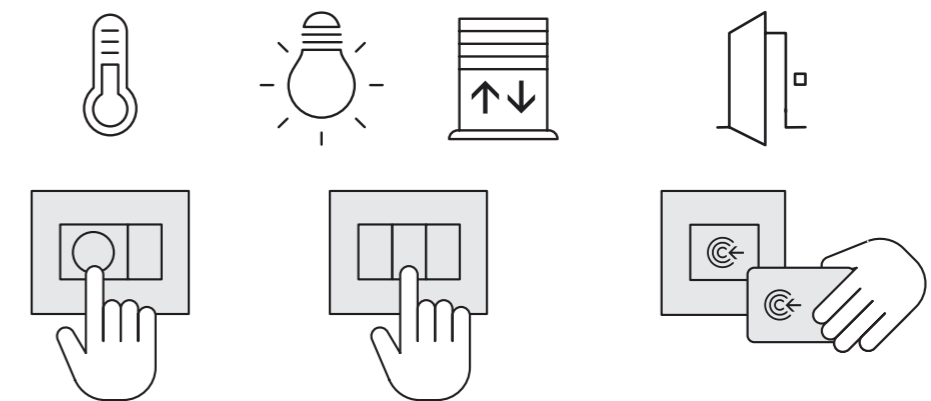

## CONNECTED WIRING SYSTEM

Now with **SMARTPHONE** and **VOCAL CONTROL** you can keep **everything under control** up close and from a distance

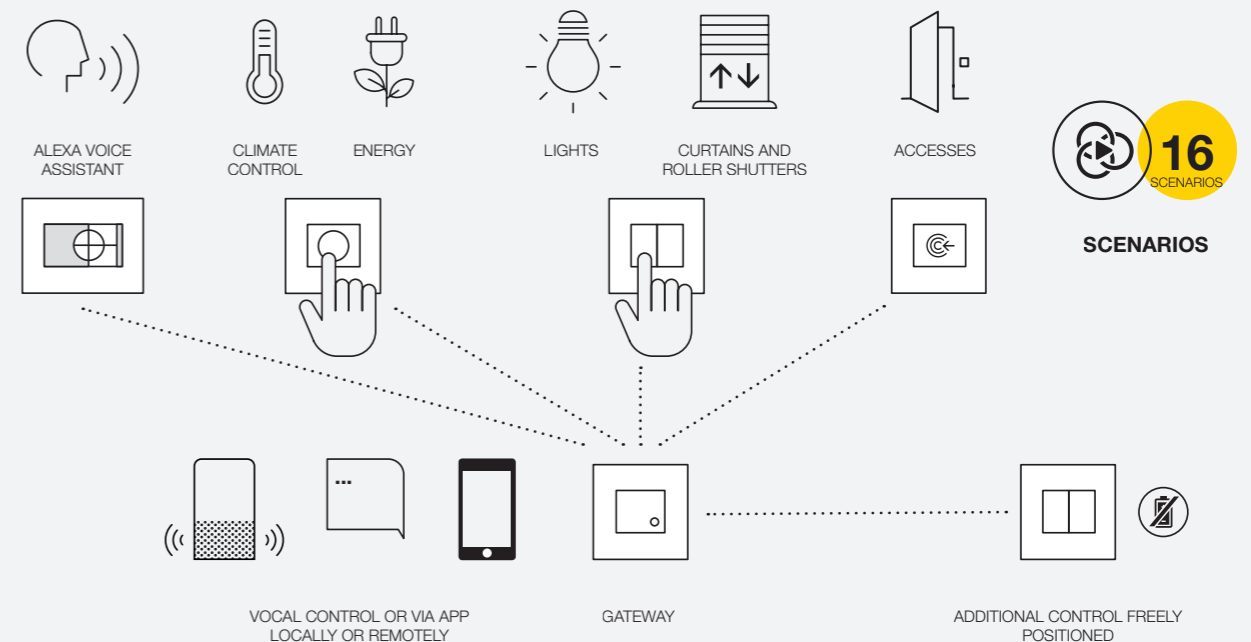

## Easier, **more functional.**

Compared to a traditional system, the connected system makes it possible to have **more functions at hand**, or **vocally** controllable. A connected home thus guarantees **greater comfort, more efficiency** and **security** both when you are inside the environments as well as when you are out of doors, enhancing the value of the property and **improving life for those who live there.**

### THE CONVENIENCE OF CONTROL VIAL APP

To control the status of lights, the position of curtains and motorised roller shutters, as well as energy loads, wherever you may be.

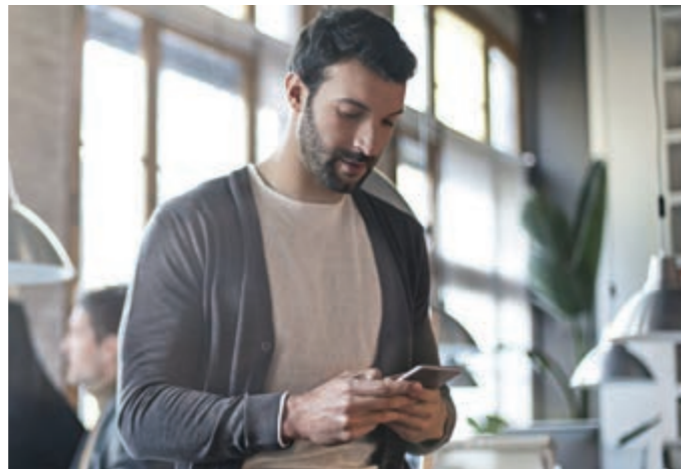
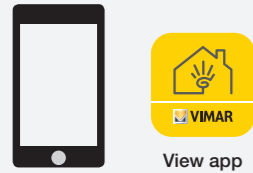

### THE SIMPLICITY OF VOCAL CONTROL

Controlling your home with your voice makes technology accessible to everyone, including the elderly or the disabled.

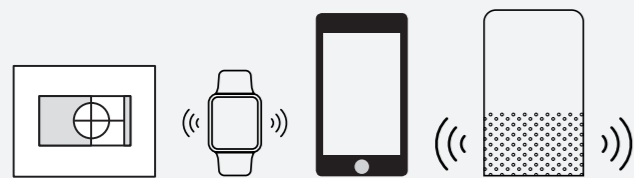

### THE CERTAINTY OF A PHYSICAL DEVICE AND THE FREEDOM OF A WIRELESS ONE

Connected devices also work in the absence of connectivity and with the use of battery-free wireless ones, you can expand your system with further functions.

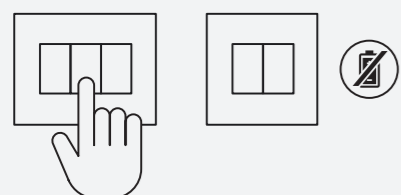

### THE PERFECT SCENARIOS WITH JUST ONE TOUCH

The centralised control to activate one of the 16 customisable scenarios makes the building truly smart. Up to 64 devices can be connected: from turning off lights, managing the temperature and controlling accesses.

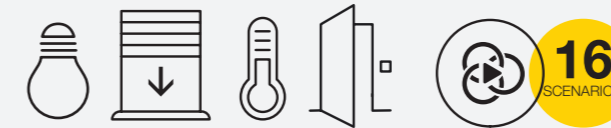

### TEMPERATURE CONTROL, COMFORT AND ENERGY SAVING

Smart thermostats for heating control and climate control for maximum comfort throughout your home, as well as to avoid energy wastage.



### KNOWING THE CONSUMPTION OF THE BUILDING TO PREVENT POWER OUTAGES

You can check the electricity consumption of your entire home or of individual appliances from your smartphone, to avoid power outages and monitor the production of the photovoltaic system.



### SMART SYSTEM FOR ACCESS CONTROL

Ideal for small and medium-sized accommodation facilities such as country guest houses and B&Bs, offering guests the very best in comfort and safety, guaranteeing the manager superior management performance and energy efficiency.

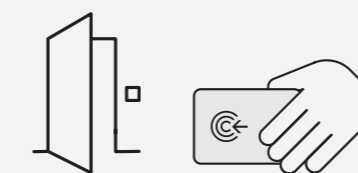

# Easy installation in just a few steps.

# All at **your fingertips** and **vocally controllable.**



### 1. CONNECTION OF THE CONNECTED DEVICES.

The installation of the connected controls is very simple; the traditional electro-mechanical devices are replaced with the corresponding connected device, one for each light or roller shutter to be controlled; in the case of energy socket outlets, simply add a serial connected actuator to the phase. The connected device must be powered with PHASE and NEUTRAL.

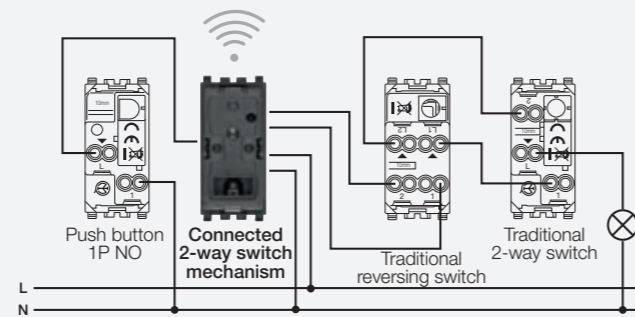

### 2. CONFIGURATION IS STRAIGHTFORWARD.

The View Wireless App is available with a guided wizard. Configuration follows a sequential flow and is guided by simple explanatory screens to create environments and associate the connected devices; the parameter setting of individual devices (operation and backlighting); the transfer of settings and parameters to the gateway with connection to the Wi-Fi network in the building.

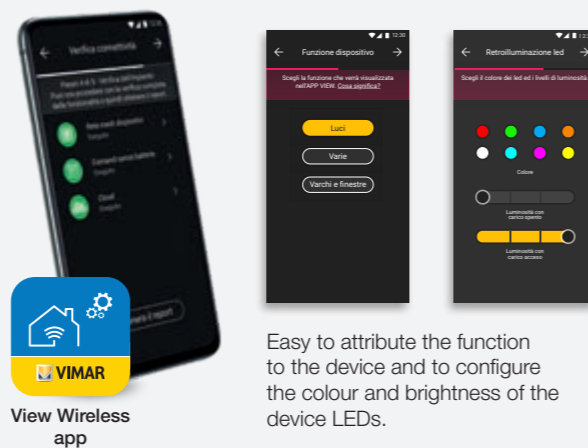

Easy to attribute the function to the device and to configure the colour and brightness of the device LEDs.

### 3. THE SMART SYSTEM IS READY, A SINGLE APP FOR YOUR CUSTOMER.

A single smart system for a future view. We offer you platforms and systems that are integrable to provide a concrete response to the needs of those who design and who live in the spaces of the future, in search of comfort and protection.



### A SINGLE APP AND MULTIPLE FUNCTIONS.

- Customise over time **up to 16 scenarios**, such as a single control (off) to switch off all the lights and lower all the roller shutters at the same time;
- **View and check** the status of lights, roller shutters or sun awnings and of the loads connected to the socket outlets;
- Programme and **manage the ideal** temperature in each room;
- **View the total** consumption of the home and of each connected socket outlet and any photovoltaic systems;
- **Receive notifications** if the contractual power level is exceeded to avoid power black-outs and in the event of malfunctioning loads;
- **Single app:** the system is expandable since the **View** app is also designed to control the other Vimar alarm and video door entry systems (By-alarm, Elvox door entry).

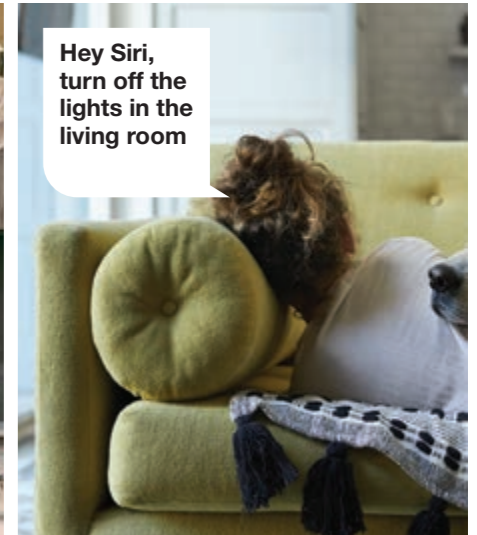
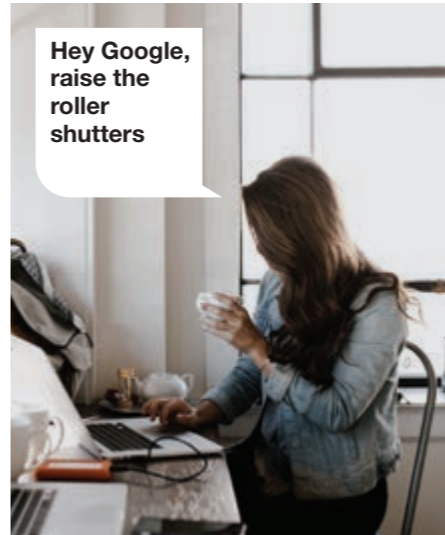



## Connected system based on Bluetooth® mesh system.

The **Bluetooth® wireless technology** standard makes it possible to use devices in a mesh network, whereby the gateway (20597, 19597 and 14597) is designed to allow the user **to control** the system **via the View app** both locally and remotely. Moreover, the system can also be controlled using Alexa, Google Assistant and Siri smart speakers. The installer **configures** the system in Bluetooth® wireless technology mode and sets all the parameters **using the View Wireless app**, which also allows the addition of battery-free remote controls, based on energy harvesting technology by EnOcean, for the activation of scenarios or the addition of other control devices.

Representation of a residential system with connected devices for temperature, lights, roller shutter and consumption control. Up to 64 devices can be connected, and up to 16 favourite scenarios can be set. Radio frequency devices can also be added to the system.

### TEMPERATURE CONTROL

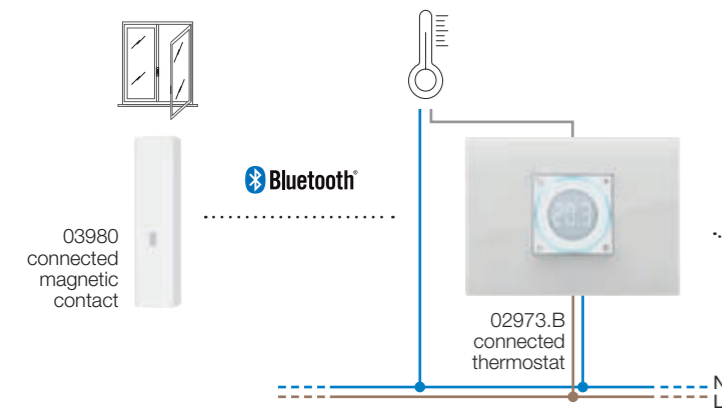

### INTEGRATION WITH RADIO FREQUENCY CONTROLS



### LIGHT CONTROL

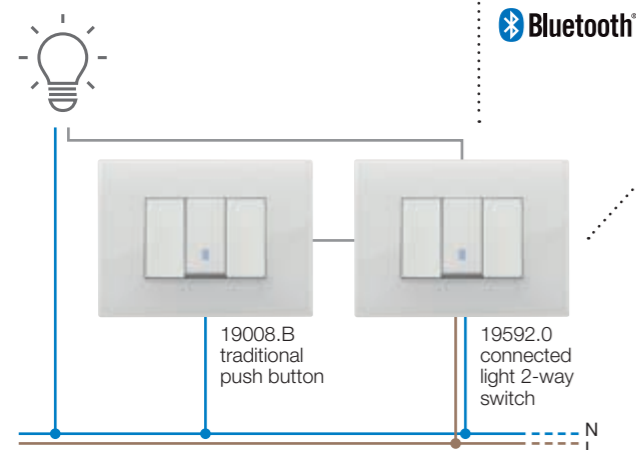

### VOCAL CONTROL

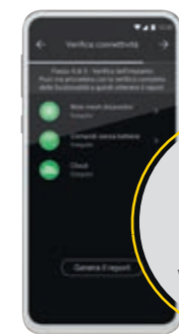
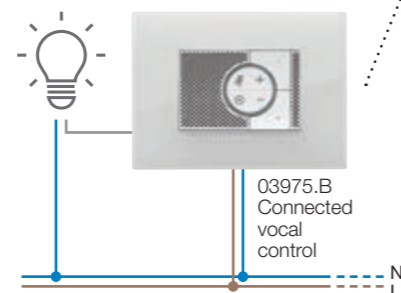

Configuration

Bluetooth

Bluetooth

Bluetooth

Bluetooth

Bluetooth

Bluetooth

Bluetooth

19597.B gateway

WiFi



Use

Works with IFTTT

### ROLLER SHUTTER CONTROL

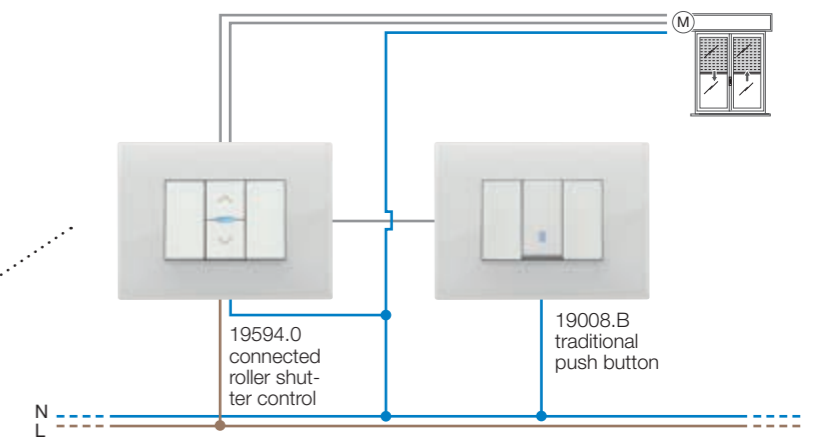

### CONSUMPTION CONTROL

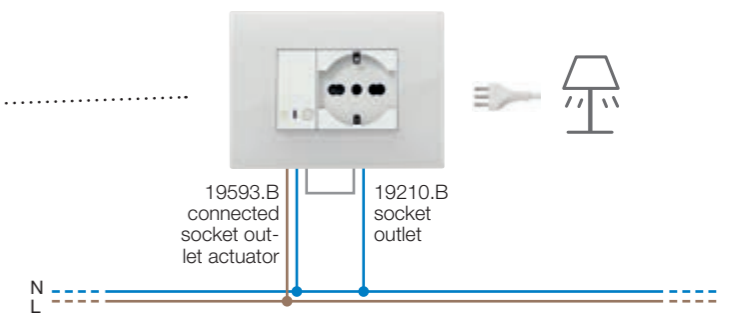

### ACCESS CONTROL

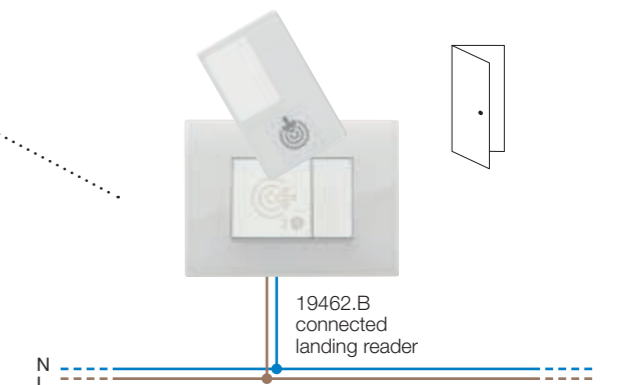

The wiring of connected devices requires a power supply (L, N) and connection to the related loads and/or electro-mechanical control devices (2-way switches, 1-way switches, push buttons). The presence of Wi-Fi Internet connection is always required, to allow the connection to the Cloud for supervision (local and remote) and for integrations with the Alexa, Google Assistant and Siri smart speakers. The system is compatible with IFTTT. By integrating IFTTT compatible third-party devices, recipes/applets can be created, involving climate control, the use of periodic timers, astronomical clocks, the weather and information about energy production or consumption. For instance, on reaching a specific internal temperature, you can turn on the air conditioning using a third-party IR interface, or turn on a light at sunset.

### Connected system based on app and Vimar cloud.

Connected system for lights, roller shutters and socket outlet with flush-mounted Wi-Fi gateway, supervision with **View** app and integration with radio frequency control with Bluetooth® Low Energy battery-free standard. Complete control with Siri, Amazon Alexa and Google Home through the Vimar Cloud and simplified configuration with the **View Wireless** app.

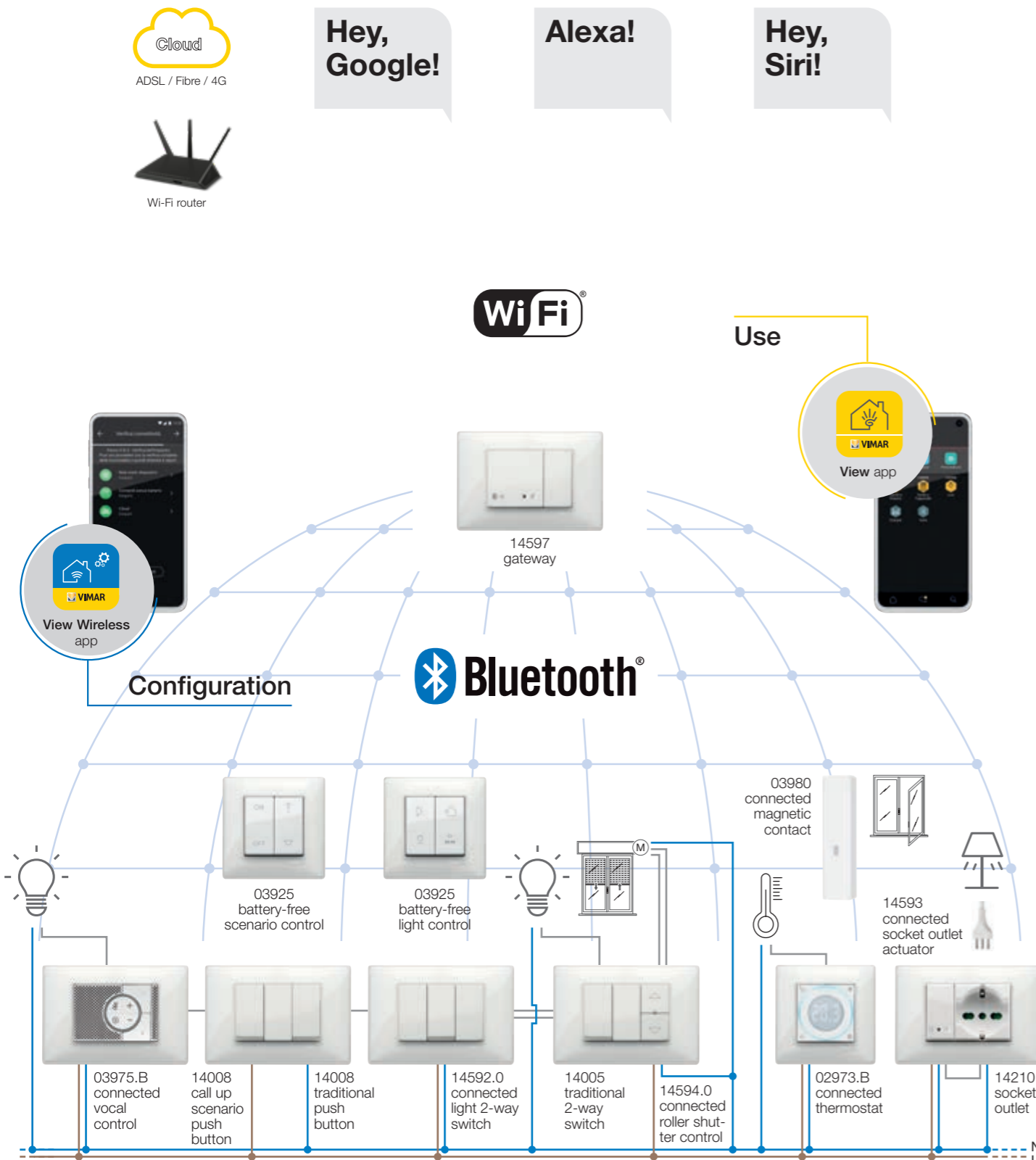

### Integration of the connected products in a smart system based on Zigbee hub, app and third-party cloud.

The **Zigbee technology** standard makes it possible to use devices directly in combination with a third-party Zigbee gateway, such as Amazon Echo (4<sup>th</sup> generation) or Show; in this mode, **configuration** takes place **by the Alexa app** and integration with vocal control is native.

The **View Wireless** app is only required to upload the Zigbee 3.0 protocol onto each individual connected device, guaranteeing use in an Alexa Smart Home without requiring additional gateways (the network HUB is Alexa).

The wiring of connected devices requires a power supply (L, N) and connection to the related loads and/or electro-mechanical control devices (2-way switches, 1-way switches, push buttons). The presence of Wi-Fi Internet connection is always required, to allow the connection to the Cloud for supervision (local and remote) and for integrations with the Alexa voice assistant.

#### System with integration of connected devices in a smart system with Amazon Echo.

Control lights, roller shutters and generic loads directly from the Alexa app with Amazon devices featuring ZigBee connectivity. The **View wireless** app is only required to upload the ZigBee firmware onto each individual connected device. Configuration is done natively via the Amazon app. The functions that can be configured and controlled depend on the third-party ZigBee Hub (in this example, the Amazon Echo smart speaker).

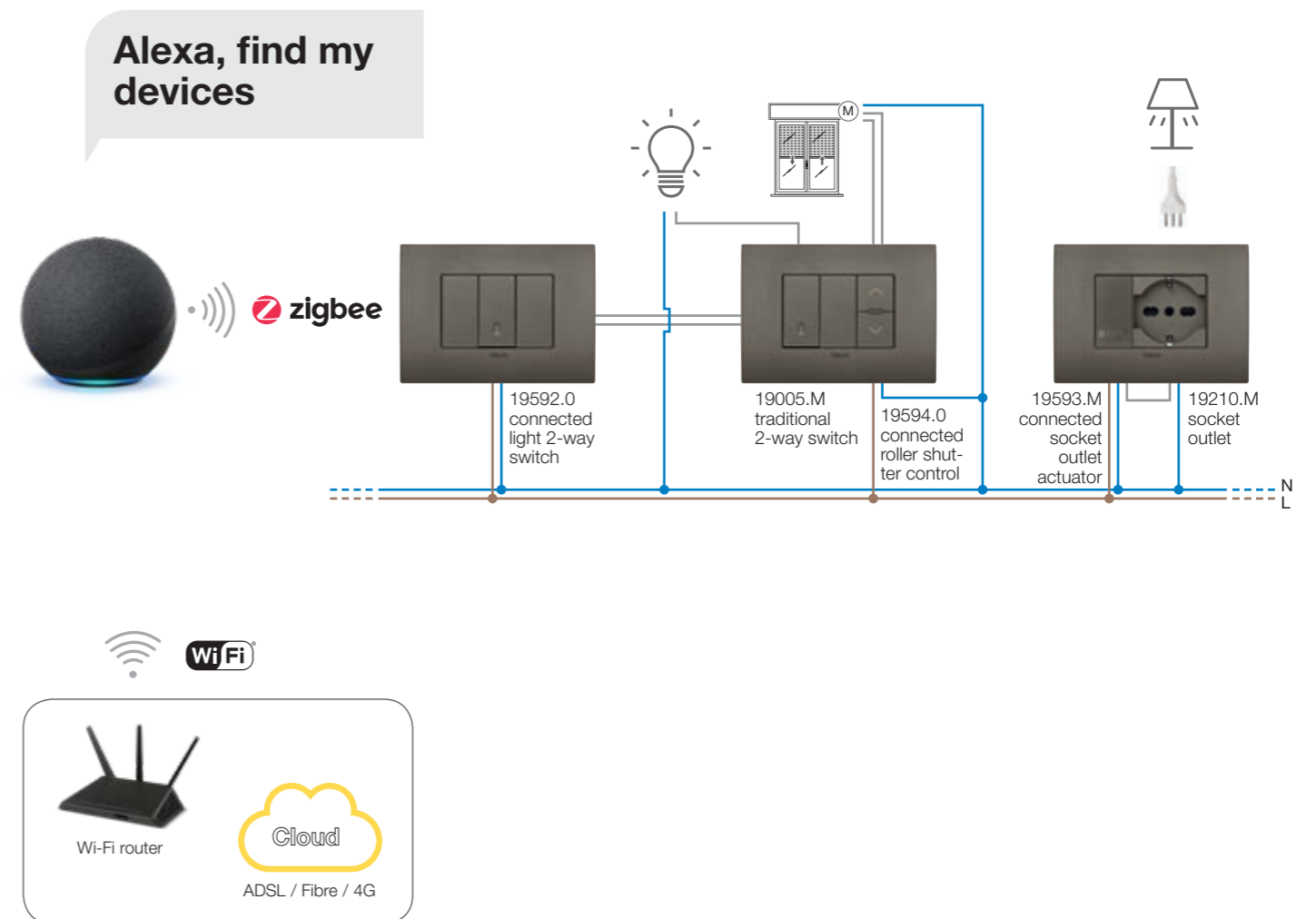

**Typical system: 160 m<sup>2</sup> villa with connected system for controlling lights, roller shutter, climate control, energy management, video door entry system, burglar alarm system, IP cameras and vocal control.**

The example shows a residential system built in a 160 m<sup>2</sup> villa, comprising a View Wireless smart home for managing lights, roller shutters, climate control and energy, a Due Fili Plus video door entry system and a By-alarm burglar alarm system, combined with some IP cameras for video check. All the functions can be managed from a smartphone and tablet both locally and remotely using the View app. In detail, the following is possible:

- control lights via connected 2-way switches 20592.0 and one light via vocal control 03975;
- control the roller shutters with slat orientation via connected controls 20594.0;

- manage the heating system, in this case consisting of 4 independent zones, via connected dial thermostats 02973;
- view the amount of energy consumed and the energy produced by the photovoltaic system via connected energy meters 02963;
- receive video calls from the Due Fili Plus entrance panel;
- manage the By-alarm burglar alarm system also via the keyboard, thanks to the connection between the burglar alarm system control unit (art. 01700) and the Internet via the gateway (art. 01712.1);
- view the images of the IP cameras, also concurrently with a burglar detection by the alarm system (video check).



Tablet or smartphone for video door entry functions, burglar alarm system management and IP camera viewing



Connected controls for managing lights and roller shutters



Connected dial thermostat for climate control



Typical system: 160 m<sup>2</sup> villa with connected system for controlling lights, roller shutter, climate control, energy management, video door entry system, burglar alarm system, IP cameras and vocal control.

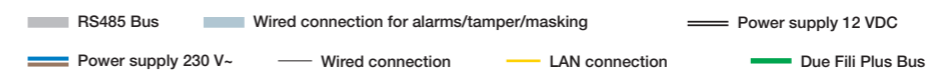
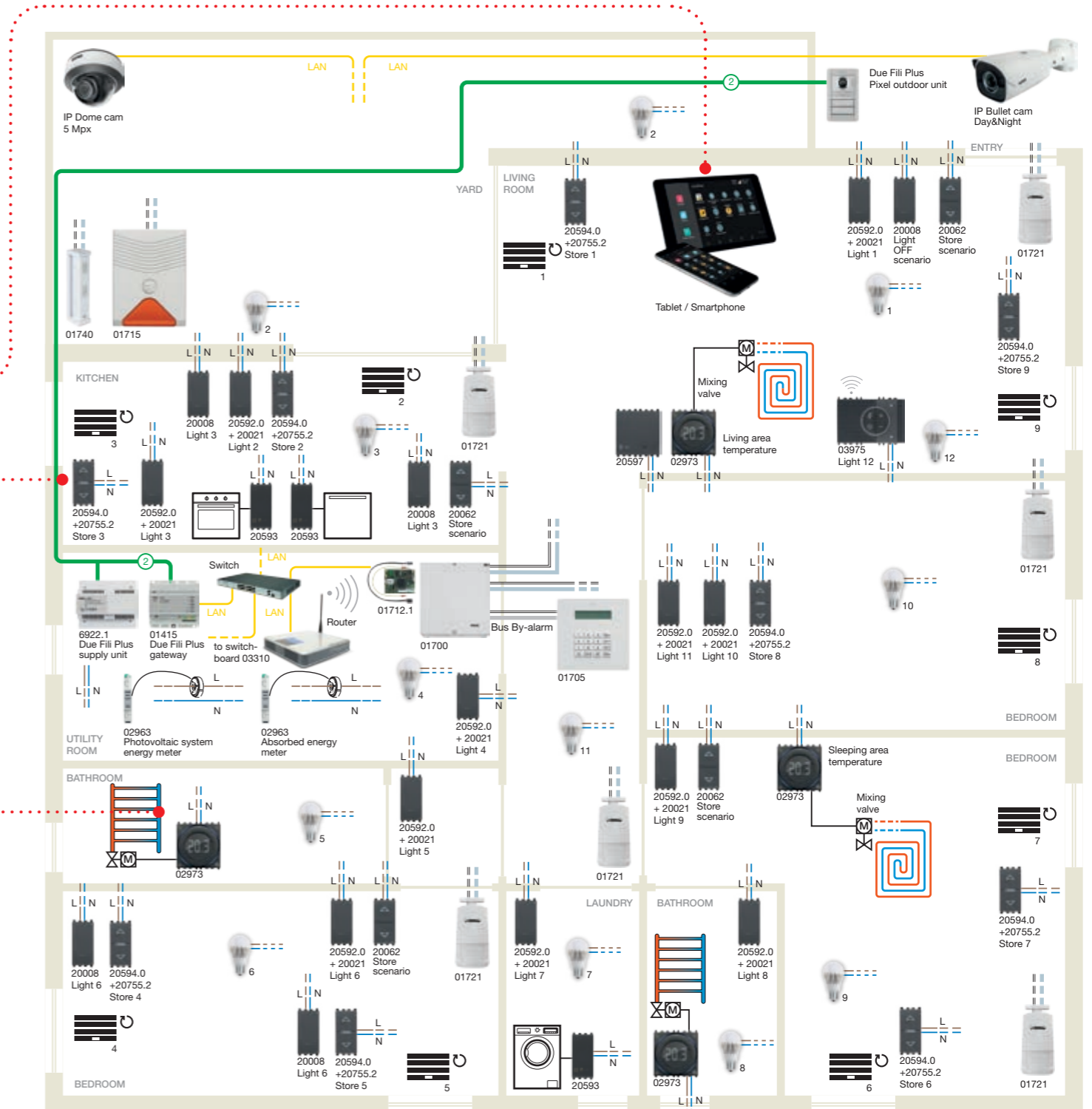

**Typical system: 90 m<sup>2</sup> apartment with connected system for controlling lights, roller shutter, climate control in zones and vocal control.**

The example illustrates a View Wireless connected system which can be managed locally or remotely via the View App, built inside a 90 m<sup>2</sup> apartment where the following is possible:

- controlling lights via connected 2-way switches 14592.0 and 1 light via vocal control 03975.B;
- controlling 6 roller shutters with slat orientation via connected controls 14594.0;

- managing the heating system, in this case consisting of 3 independent zones, via connected dial thermostats 02973.B. The presence of the gateway (art. 14597), via **Bluetooth® wireless technology** allows system supervision both locally and remotely via the View app.

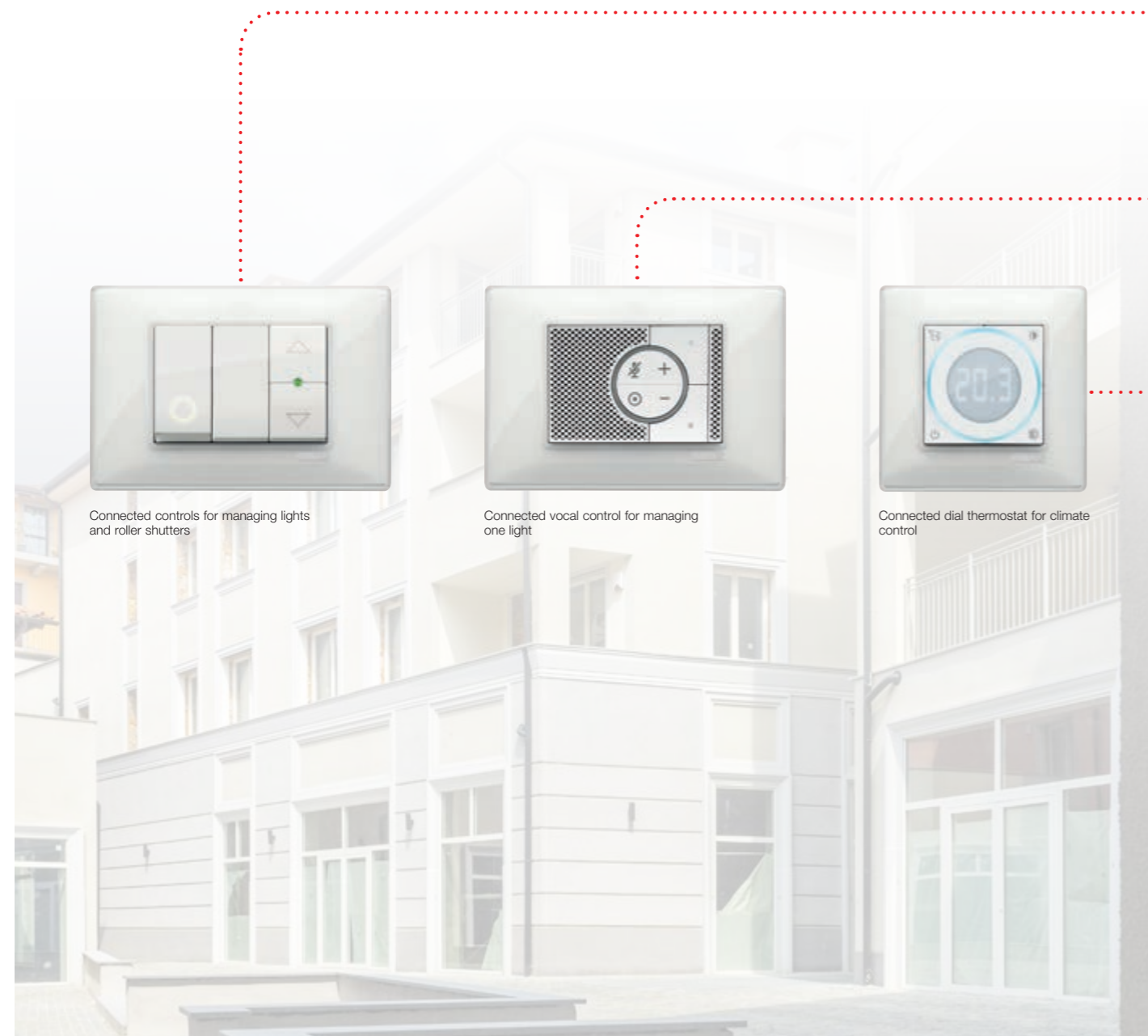

Typical system: 90 m<sup>2</sup> apartment with connected system for controlling lights, roller shutter, climate control in zones and vocal control.

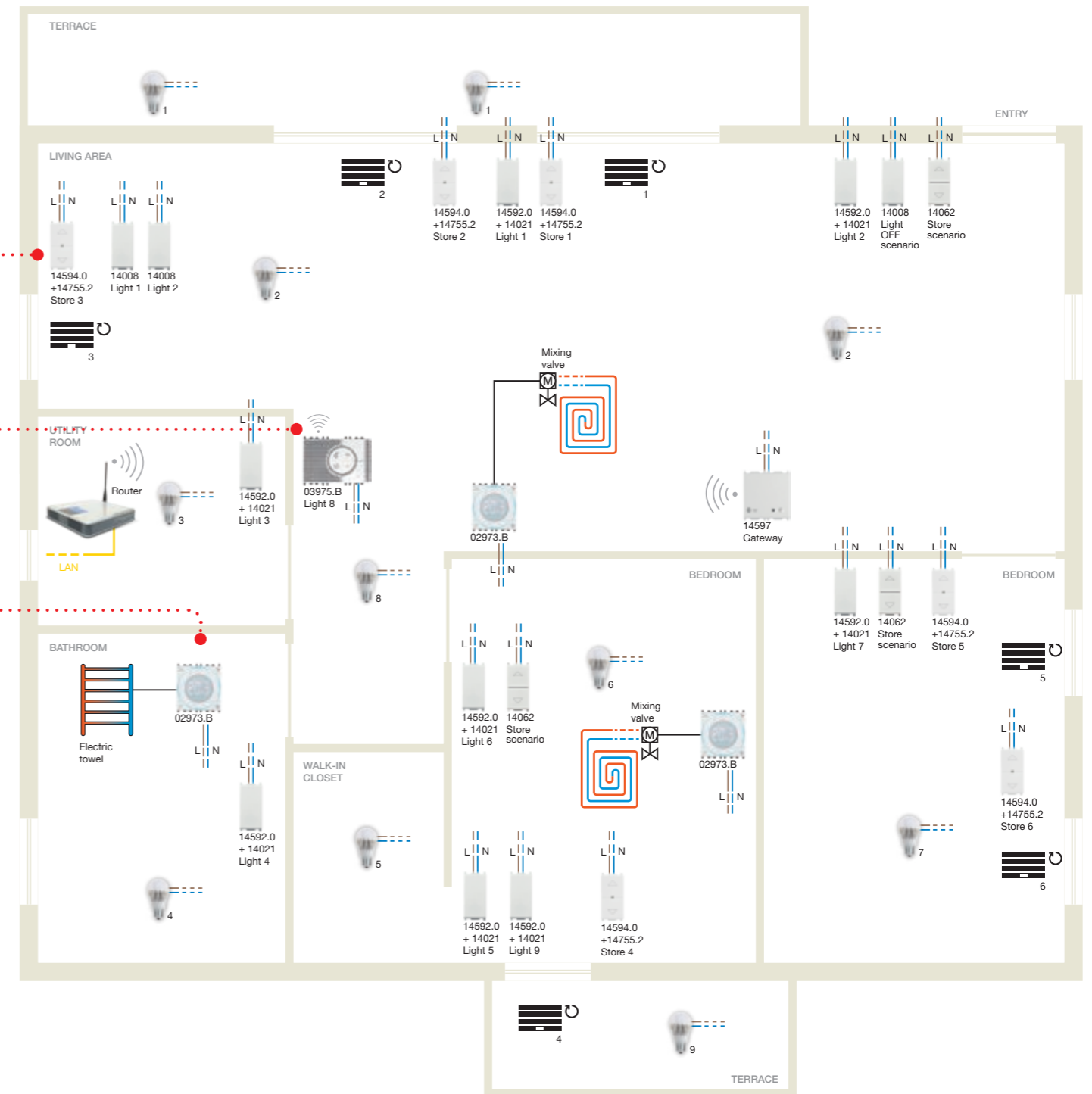

**Typical system: B&B with four bedrooms with roller shutter management, climate control, access control and Wi-Fi Internet network.**

An access control system for small tertiary contexts (such as Bed&Breakfasts, country houses, etc.), based on **Bluetooth® wireless technology**. Thanks to gateway 19597.B, the system can be integrated with other connected devices and also allow the remote opening of the door and the room status control. Moreover, customised scenarios can be created to manage roller shutters and climate control in the rooms via the View app.

The example illustrates a standard solution for a B&B with four guest rooms.

- Outside the rooms, transponder card readers 19462.B have

been installed, fitted with a "do not disturb" signal LED which can be activated from the inside.

- Inside the rooms, the "energy saver" transponder pocket 19467.B is installed, which activates the utilities (lights and power socket outlets) when the transponder card is inserted.
- A connected thermostat 02973.B is installed in each room, to control the temperature, not just from the front dial, but also remotely via the View App.
- Wi-Fi access points 19195.B are installed in all the rooms and in the corridor to guarantee the web connection via mobile devices (PC, tablet or smartphone) to guests.



Typical system: B&B with four bedrooms with roller shutter management, climate control, access control and Wi-Fi Internet network.

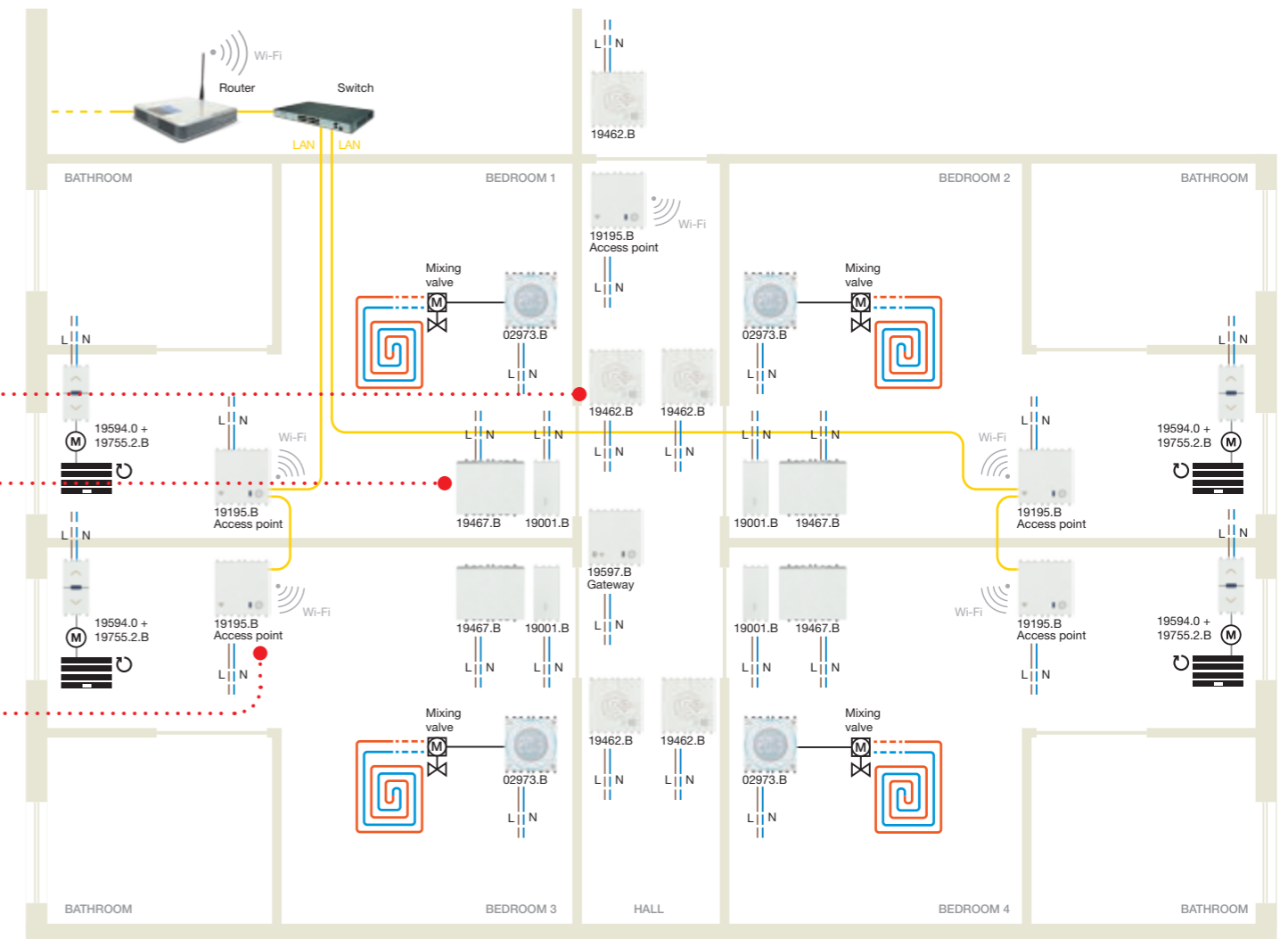

— Power supply 230 V~ — LAN connection

Typical system: B&B with three rooms and access control system.

An access control system for small tertiary contexts (such as Bed&Breakfasts, country houses, etc.), based on **Bluetooth® wireless technology**. The devices are programmed via the View Wireless App, which associates the transponder cards with each device, to grant access and permit the use of the services in the room safely and securely.

The system can work in **stand-alone** mode; via the **View Wireless App**, the installer **configures** the system, the facility manager then programmes the **accesses** and lastly, the customer with the transponder card can access his or her room and other communal rooms, if authorised to do so. By adding the **gateway**, the system can be integrated with other connected

devices and also allow **the remote opening of the door and the room state control**.

The system consists of:

- **transponder reader** to be installed on the landing, fitted with "do not disturb" signal LED activated from the insider;
- "energy saver" transponder pocket to activate the services in the room.

The two devices can use the "relay change-over" (reader-pocket) function, which allows the door to be opened via the pocket contact and the room loads to be activated via the reader relay, to achieve a higher level of **safety**. This function is available in both the stand-alone mode and with the gateway.



Typical system: B&B with three rooms and access control system.

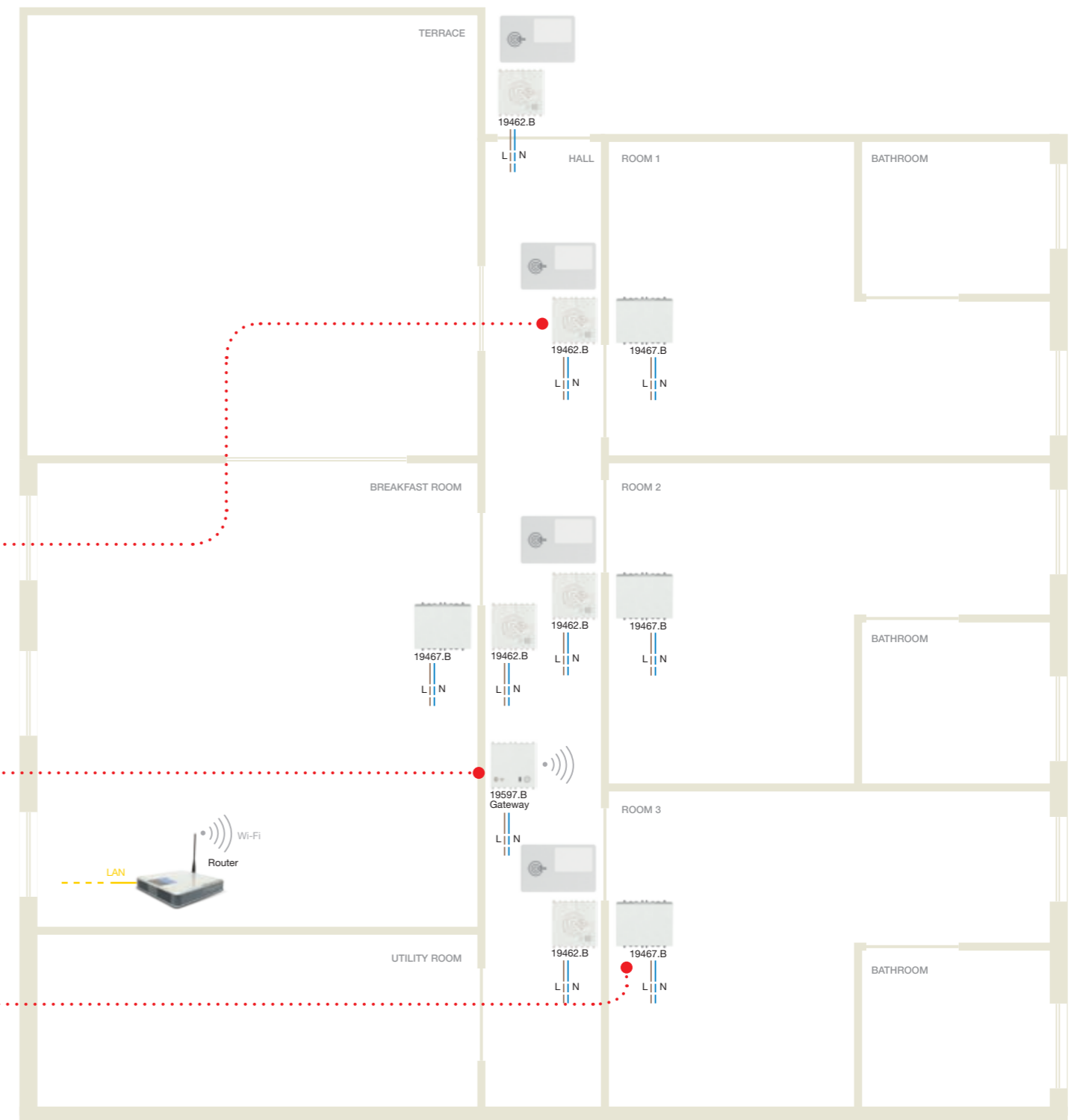

EIKON ARKÉ IDEA PLANA

Gateway



**20597**  
View Wireless gateway, Bluetooth® wireless technology 4.2 Wi-Fi, 100-240 V 50/60 Hz power supply, grey - 2 modules. Depth: 37 mm



**19597**  
View Wireless gateway, Bluetooth® wireless technology 4.2 Wi-Fi, 100-240 V 50/60 Hz power supply, grey - 2 modules. Depth: 36,7 mm



**16497**  
View Wireless gateway, Bluetooth® wireless technology 4.2 Wi-Fi, 100-240 V 50/60 Hz power supply, grey - 2 modules. Depth: 36,9 mm



**14597**  
View Wireless gateway, Bluetooth® wireless technology 4.2 Wi-Fi, 100-240 V 50/60 Hz power supply, white - 2 modules. Depth: 36 mm



**20597.B**  
View Wireless gateway, Bluetooth® wireless technology 4.2 Wi-Fi, 100-240 V 50/60 Hz power supply, white - 2 modules. Depth: 37 mm



**19597.B**  
View Wireless gateway, Bluetooth® wireless technology 4.2 Wi-Fi, 100-240 V 50/60 Hz power supply, white - 2 modules. Depth: 36,7 mm



**16497.B**  
View Wireless gateway, Bluetooth® wireless technology 4.2 Wi-Fi, 100-240 V 50/60 Hz power supply, white - 2 modules. Depth: 36,9 mm



**14597.SL**  
View Wireless gateway, Bluetooth® wireless technology 4.2 Wi-Fi, 100-240 V 50/60 Hz power supply, Silver - 2 modules. Depth: 36 mm



**20597.N**  
View Wireless gateway, Bluetooth® wireless technology 4.2 Wi-Fi, 100-240 V 50/60 Hz power supply, Next - 2 modules. Depth: 37 mm



**19597.M**  
View Wireless gateway, Bluetooth® wireless technology 4.2 Wi-Fi, 100-240 V 50/60 Hz power supply, Metal - 2 modules. Depth: 36,7 mm

Neve Up - Gateway



**OK14597.01**  
View Wireless gateway, Bluetooth® wireless technology 4.2 Wi-Fi, 100-240 V 50/60 Hz power supply, installation on DIN rail (60715 TH35), occupies 2 17,5 mm modules



View Wireless connected voice controls



**▲03975**  
Alexa built-in with built-in Wi-Fi, 2 frontal buttons, RGB LED backlighting, 1 input for wired push button, 1 NO 100-240 V 50/60 Hz relay output for 500 W incandescent lamps, 100 W LED lamps, 250 VA electronic transformers, 120 W fluorescent lamps, local or remote control, for View Wireless mesh system Bluetooth® wireless technology 5.0 or By-me Plus, 100-240 V 50/60 Hz power supply, grey - 3 modules. Depth: 35 mm To be completed with Eikon, Arké and Plana cover plates, for Idea with dedicated mounting frame 16723



**▲03975.B**  
Alexa built-in with built-in Wi-Fi, 2 frontal buttons, RGB LED backlighting, 1 input for wired push button, 1 NO 100-240 V 50/60 Hz relay output for 500 W incandescent lamps, 100 W LED lamps, 250 VA electronic transformers, 120 W fluorescent lamps, local or remote control, for View Wireless mesh system Bluetooth® wireless technology 5.0 or By-me Plus, 100-240 V 50/60 Hz power supply, white - 3 modules. Depth: 35 mm To be completed with Eikon, Arké and Plana cover plates, for Idea with dedicated mounting frame 16723



**▲03975.N**  
Alexa built-in with built-in Wi-Fi, 2 frontal buttons, RGB LED backlighting, 1 input for wired push button, 1 NO 100-240 V 50/60 Hz relay output for 500 W incandescent lamps, 100 W LED lamps, 250 VA electronic transformers, 120 W fluorescent lamps, local or remote control, for View Wireless mesh system Bluetooth® wireless technology 5.0 or By-me Plus, 100-240 V 50/60 Hz power supply, white - 3 modules. Depth: 35 mm To be completed with Eikon, Arké and Plana cover plates, for Idea with dedicated mounting frame 16723



**▲03975.M**  
Alexa built-in with built-in Wi-Fi, 2 frontal buttons, RGB LED backlighting, 1 input for wired push button, 1 NO 100-240 V 50/60 Hz relay output for 500 W incandescent lamps, 100 W LED lamps, 250 VA electronic transformers, 120 W fluorescent lamps, local or remote control, for View Wireless mesh system Bluetooth® wireless technology 5.0 or By-me Plus, 100-240 V 50/60 Hz power supply, Metal - 3 modules. Depth: 35 mm To be completed with Eikon, Arké and Plana cover plates, for Idea with dedicated mounting frame 16723



EIKON ARKÉ IDEA PLANA

Arké - View Wireless connected 2-way switches kits



**0K19592.01**  
Kit with:  
• 1 19592.0 2-way switch mechanism (Zigbee pre-configured)  
• 1 19022.B 2-module interchangeable button, white  
• 1 19607 2-module British standard mounting frame  
• 1 19603 2-module mounting frame without screws  
• 1 19642.74 2-module technopolymer Classic cover plate, white



**0K19592.02**  
Kit with:  
• 1 19592.0 2-way switch mechanism (Zigbee pre-configured)  
• 1 19022 2-module interchangeable button, grey  
• 1 19607 2-module British standard mounting frame  
• 1 19603 2-module mounting frame without screws  
• 1 19642.71 2-module technopolymer Classic cover plate, black

View Wireless connected 2-way switches



**20592.0**  
Mechanism, 100-240 V 50/60 Hz relay output for 500 W incandescent lamps, 100 W LED lamps, 250 VA electronic transformers, 120 W fluorescent lamps, Bluetooth® wireless technology 5.0 for View Wireless mesh system and Zigbee 3.0, 1 input for actuator push button or recall a scenario. To complete with 1-, 2- or 3-module buttons. Depth: 37,5 mm



**19592.0**  
Mechanism, 100-240 V 50/60 Hz relay output for 500 W incandescent lamps, 100 W LED lamps, 250 VA electronic transformers, 120 W fluorescent lamps, Bluetooth® wireless technology 5.0 for View Wireless mesh system and Zigbee 3.0, 1 input for actuator push button or recall a scenario. To complete with 1-, 2- or 3-module buttons. Depth: 36,5 mm



**16492**  
View Wireless electronic 2-way switch, 100-240 V 50/60 Hz relay output for 500 W incandescent lamps, 100 W LED lamps, 250 VA electronic transformers, 120 W fluorescent lamps, Bluetooth® wireless technology 5.0 for View Wireless mesh system and Zigbee 3.0, 1 input for actuator push button or recall a scenario, grey. Depth: 37,6 mm



**14592.0**  
Mechanism, 100-240 V 50/60 Hz relay output for 500 W incandescent lamps, 100 W LED lamps, 250 VA electronic transformers, 120 W fluorescent lamps, Bluetooth® wireless technology 5.0 for View Wireless mesh system and Zigbee 3.0, 1 input for actuator push button or recall a scenario. To complete with 1-, 2- or 3-module buttons. Depth: 36,5 mm



**16492.B**  
View Wireless electronic 2-way switch, 100-240 V 50/60 Hz relay output for 500 W incandescent lamps, 100 W LED lamps, 250 VA electronic transformers, 120 W fluorescent lamps, Bluetooth® wireless technology 5.0 for View Wireless mesh system and Zigbee 3.0, 1 input for actuator push button or recall a scenario, white. Depth: 37,6 mm

EIKON ARKÉ PLANA

1-module interchangeable buttons for connected switch mechanism (lightable)

20021 No symbol, grey	20021.B No symbol, white	20021.N No symbol, Next	19021 No symbol, grey	19021.B No symbol, white	19021.M No symbol, Metal	14021 No symbol, white	14021.SL No symbol, Silver
20021.L Light symbol, grey	20021.L.B Light symbol, white	20021.L.N Light symbol, Next	19021.L Light symbol, grey	19021.L.B Light symbol, white	19021.L.M Light symbol, Metal	14021.L Light symbol, white	14021.L.SL Light symbol, Silver
20021.P Key symbol, grey	20021.P.B Key symbol, white	20021.P.N Key symbol, Next	19021.P Key symbol, grey	19021.P.B Key symbol, white	19021.P.M Key symbol, Metal	14021.P Key symbol, white	14021.P.SL Key symbol, Silver
20026 With diffuser, grey	20026.B With diffuser, white	20026.N With diffuser, Next	19026 With diffuser, grey	19026.B With diffuser, white	19026.M With diffuser, Metal	14026 With diffuser, white	14026.SL With diffuser, Silver
20026.PLS Please Clean with diffuser, grey	20026.PLS.B Please Clean with diffuser, white	20026.PLS.N Please Clean with diffuser, Next	19026.PLS Please Clean with diffuser, grey	19026.PLS.B Please Clean with diffuser, white	19026.PLS.M Please Clean with diffuser, Metal	14026.PLS Please Clean with diffuser, white	14026.PLS.SL Please Clean with diffuser, Silver
20026.DND Do Not Disturb with diffuser, grey	20026.DND.B Do Not Disturb with diffuser, white	20026.DND.N Do Not Disturb with diffuser, Next	19026.DND Do Not Disturb with diffuser, grey	19026.DND.B Do Not Disturb with diffuser, white	19026.DND.M Do Not Disturb with diffuser, Metal	14026.DND Do Not Disturb with diffuser, white	14026.DND.SL Do Not Disturb with diffuser, Silver
20031 Customizable, grey	20031.B Customizable, white	20031.N Customizable, Next	19031 Customizable, grey	19031.B Customizable, white	19031.M Customizable, Metal	14021.G Customizable, white	14021.G.SL Customizable, Silver

EIKON ARKÉ PLANA

1-module interchangeable buttons for connected switch mechanism (lightable)

19038 Smooth, non-lightable, grey	19038.B Smooth, non-lightable, white	19038.M Smooth, non-lightable, Metal	14029 With name plate, white	14029.SL With name plate, Silver

2-module interchangeable buttons for connected switch mechanism (lightable)

20022 No symbol, grey	20022.B No symbol, white	20022.N No symbol, Next	19022 No symbol, grey	19022.B No symbol, white	19022.M No symbol, Metal	14022 No symbol, white	14022.AB No symbol, with antibacterial treatment, white	14022.SL No symbol, Silver
20022.L Light symbol, grey	20022.L.B Light symbol, white	20022.L.N Light symbol, Next	19022.L Light symbol, grey	19022.L.B Light symbol, white	19022.L.M Light symbol, Metal	14022.L Light symbol, white	14022.L.SL Light symbol, Silver	
20022.P Key symbol, grey	20022.P.B Key symbol, white	20022.P.N Key symbol, Next	19022.P Key symbol, grey	19022.P.B Key symbol, white	19022.P.M Key symbol, Metal	14022.P Key symbol, white	14022.P.SL Key symbol, Silver	
20027 With diffuser, grey	20027.B With diffuser, white	20027.N With diffuser, Next	19027 With diffuser, grey	19027.B With diffuser, white	19027.M With diffuser, Metal	14027 With diffuser, white	14027.SL With diffuser, Silver	
20032 Customizable, grey	20032.B Customizable, white	20032.N Customizable, Next	19032 Customizable, grey	19032.B Customizable, white	19032.M Customizable, Metal	14022.G Customizable, white	14022.G.SL Customizable, Silver	



EIKON ARKÉ PLANA

3-module interchangeable buttons for connected switch mechanism (lightable)

<b>20023</b> No symbol, grey	<b>20023.B</b> No symbol, white	<b>19023</b> No symbol, grey	<b>19023.B</b> No symbol, white	<b>14023</b> No symbol, white	<b>14023.SL</b> No symbol, Silver
<b>20023.N</b> No symbol, Next		<b>19023.M</b> No symbol, Metal			
<b>20028</b> With diffuser, grey	<b>20028.B</b> With diffuser, white	<b>19028</b> With diffuser, grey	<b>19028.B</b> With diffuser, white	<b>14028</b> With diffuser, white	<b>14028.SL</b> With diffuser, Silver
<b>20028.N</b> With diffuser, Next		<b>19028.M</b> With diffuser, Metal			
<b>20033</b> Customizable, grey	<b>20033.B</b> Customizable, white	<b>19033</b> Customizable, grey	<b>19033.B</b> Customizable, white	<b>14023.G</b> Customizable, white	<b>14023.G.SL</b> Customizable, Silver
<b>20033.N</b> Customizable, Next		<b>19033.M</b> Customizable, Metal			

EIKON ARKÉ IDEA PLANA

View Wireless connected device for 1 roller shutter



<b>20594.0</b> With slat orientation and change-over relay output for cosφ 0,6 motor 2 A 100-240 V~50/60 Hz, Bluetooth® wireless technology 5.0 for View Wireless mesh system and Zigbee 3.0, 1 input for external push button to recall a scenario, favourite position recall function. To complete with 2 1-module half-button. Depth: 37,5 mm	<b>19594.0</b> With slat orientation and change-over relay output for cosφ 0,6 motor 2 A 100-240 V~50/60 Hz, Bluetooth® wireless technology 5.0 for View Wireless mesh system and Zigbee 3.0, 1 input for external push button to recall a scenario, favourite position recall function. To complete with 2 1-module half-button. Depth: 36,5 mm	<b>16494</b> With slat orientation and change-over relay output for cosφ 0,6 motor 2 A 100-240 V~50/60 Hz, Bluetooth® wireless technology 5.0 for View Wireless mesh system and Zigbee 3.0, 1 input for external push button to recall a scenario, favourite position recall function, grey. Depth: 37,5 mm	<b>14594.0</b> With slat orientation and change-over relay output for cosφ 0,6 motor 2 A 100-240 V~50/60 Hz, Bluetooth® wireless technology 5.0 for View Wireless mesh system and Zigbee 3.0, 1 input for external push button to recall a scenario, favourite position recall function. To complete with 2 1-module half-button. Depth: 36,5 mm
		<b>16494.B</b> With slat orientation and change-over relay output for cosφ 0,6 motor 2 A 100-240 V~50/60 Hz, Bluetooth® wireless technology 5.0 for View Wireless mesh system and Zigbee 3.0, 1 input for external push button to recall a scenario, favourite position recall function, white. Depth: 37,5 mm	

Interchangeable 1-module half-buttons for View Wireless devices

<b>20755.2</b> Arrows symbol, grey	<b>20755.2.B</b> Arrows symbol, white	<b>19755.2</b> Arrows symbol, grey	<b>19755.2.B</b> Arrows symbol, white	<b>14755.2</b> Arrows symbol, white	<b>14755.2.SL</b> Arrows symbol, Silver
<b>20755.2.N</b> Arrows symbol, Next		<b>19755.2.M</b> Arrows symbol, Metal			

View Wireless connected actuator for 1 roller shutter - backside installation



**03982**  
Actuator for 1 roller shutter with slat orientation and change-over relay output for cosφ 0,6 motor 2 A 100-240 V~ 50/60 Hz, remote control, Bluetooth® wireless technology 5.0 for View Wireless mesh system and Zigbee 3.0, flush mounting (retrofit)

EIKON	ARKÉ	IDEA	PLANA
-------	------	------	-------

Radiofrequency device



**03925<sup>1</sup>**  
4-button flat device with RF transmission, 2.4 GHz, Bluetooth® Low Energy wireless technology standard, energy harvesting supply powered by built-in electrodynamic generator, to complete with 20506 or 20506.2, 19506 or 19506.2, 16526 or 16526.2, 14506 or 14506.2 buttons - 2 modules

View Wireless connected control device for socket outlet



**20593**  
Control device with NO 16 A 100-240 V-50/60 Hz relay output, local control with push button or remote control, Bluetooth® wireless technology 5.0 for View Wireless mesh system and Zigbee 3.0, function for measuring the instant power and load cut-off threshold, grey.  
Depth: 39,5 mm



**19593**  
Control device with NO 16 A 100-240 V-50/60 Hz relay output, local control with push button or remote control, Bluetooth® wireless technology 5.0 for View Wireless mesh system and Zigbee 3.0, function for measuring the instant power and load cut-off threshold, grey.  
Depth: 39 mm



**16493**  
Control device with NO 16 A 100-240 V-50/60 Hz relay output, local control with push button or remote control, Bluetooth® wireless technology 5.0 for View Wireless mesh system and Zigbee 3.0, function for measuring the instant power and load cut-off threshold, grey.  
Depth: 39,5 mm



**14593**  
Control device with NO 16 A 100-240 V-50/60 Hz relay output, local control with push button or remote control, Bluetooth® wireless technology 5.0 for View Wireless mesh system and Zigbee 3.0, function for measuring the instant power and load cut-off threshold, white.  
Depth: 38,5 mm



**20593.B**  
Control device with NO 16 A 100-240 V-50/60 Hz relay output, local control with push button or remote control, Bluetooth® wireless technology 5.0 for View Wireless mesh system and Zigbee 3.0, function for measuring the instant power and load cut-off threshold, white.  
Depth: 39,5 mm



**19593.B**  
Control device with NO 16 A 100-240 V-50/60 Hz relay output, local control with push button or remote control, Bluetooth® wireless technology 5.0 for View Wireless mesh system and Zigbee 3.0, function for measuring the instant power and load cut-off threshold, white.  
Depth: 39 mm



**16493.B**  
Control device with NO 16 A 100-240 V-50/60 Hz relay output, local control with push button or remote control, Bluetooth® wireless technology 5.0 for View Wireless mesh system and Zigbee 3.0, function for measuring the instant power and load cut-off threshold, white.  
Depth: 39,5 mm



**14593.SL**  
Control device with NO 16 A 100-240 V-50/60 Hz relay output, local control with push button or remote control, Bluetooth® wireless technology 5.0 for View Wireless mesh system and Zigbee 3.0, function for measuring the instant power and load cut-off threshold, Silver.  
Depth: 38,5 mm



**20593.N**  
Control device with NO 16 A 100-240 V-50/60 Hz relay output, local control with push button or remote control, Bluetooth® wireless technology 5.0 for View Wireless mesh system and Zigbee 3.0, function for measuring the instant power and load cut-off threshold, Next.  
Depth: 39,5 mm



**19593.M**  
Control device with NO 16 A 100-240 V-50/60 Hz relay output, local control with push button or remote control, Bluetooth® wireless technology 5.0 for View Wireless mesh system and Zigbee 3.0, function for measuring the instant power and load cut-off threshold, Metal.  
Depth: 39 mm

EIKON	ARKÉ	PLANA
-------	------	-------

View Wireless connected actuator - backside installation



**03981**  
Control device with NO 100-240 V 50/60 Hz relay output for 500 W incandescent lamps, 100 W LED lamps, 250 VA electronic transformers, 120 W fluorescent lamps, remote control, 1 input for wired control to recall a scenario, Bluetooth® wireless technology 5.0 for View Wireless mesh system and Zigbee 3.0, flush mounting (retrofit)

View Wireless connected thermostat



**02973**  
Rotary dial thermostat for ambient temperature control, 5(2) A 240 V- relay output, View Wireless technology on Bluetooth® wireless technology 5.0 for mesh View Wireless system realization, 1 input for outer temperature sensor, supply voltage 100-240 V- 50/60 Hz, heating and air-conditioning ON/OFF and PID, class I temperature control device (contribution 1%) in ON/OFF mode, class IV (contribution 2%) in PID mode, white LED backlighting and brightness regulation, supply voltage 100-240 V 50/60 Hz, grey - 2 modules. To be completed with Eikon, Arké and Plana cover plates. For Idea with dedicated mounting frame 16723.  
Depth: 28,5 mm



**02973.B**  
Rotary dial thermostat for ambient temperature control, 5(2) A 240 V- relay output, View Wireless technology on Bluetooth® wireless technology 5.0 for mesh View Wireless system realization, 1 input for outer temperature sensor, supply voltage 100-240 V- 50/60 Hz, heating and air-conditioning ON/OFF and PID, class I temperature control device (contribution 1%) in ON/OFF mode, class IV (contribution 2%) in PID mode, white LED backlighting and brightness regulation, supply voltage 100-240 V 50/60 Hz, white - 2 modules. To be completed with Eikon, Arké and Plana cover plates. For Idea with dedicated mounting frame 16723.  
Depth: 28,5 mm



**▲09473.CM**  
Rotary dial thermostat for ambient temperature control, 5(2) A 240 V- relay output, View Wireless technology on Bluetooth® wireless technology 5.0 for mesh View Wireless system realization, 1 input for outer temperature sensor, supply voltage 100-240 V- 50/60 Hz, heating and air-conditioning ON/OFF and PID, class I temperature control device (contribution 1%) in ON/OFF mode, class IV (contribution 2%) in PID mode, white LED backlighting and brightness regulation, supply voltage 100-240 V 50/60 Hz, Carbon Matt - 2 modules. To be completed with Neve Up cover plates.  
Depth: 28,5 mm



**▲09473**  
Rotary dial thermostat for ambient temperature control, 5(2) A 240 V- relay output, View Wireless technology on Bluetooth® wireless technology 5.0 for mesh View Wireless system realization, 1 input for outer temperature sensor, supply voltage 100-240 V- 50/60 Hz, heating and air-conditioning ON/OFF and PID, class I temperature control device (contribution 1%) in ON/OFF mode, class IV (contribution 2%) in PID mode, white LED backlighting and brightness regulation, supply voltage 100-240 V 50/60 Hz, white - 2 modules. To be completed with Neve Up cover plates.  
Depth: 28,5 mm

View Wireless connected magnetic contact



**03980**  
Connected magnetic contact for windows and doors, View Wireless, Bluetooth® wireless technology 5.0 standard technology for mesh system realization, 1 clean-contact input, powered with AA LR6 1,5 V batteries (not supplied), white. To use as accessory of connected thermostat or with gateway as sensor for notification of magnetic contact open/close

View Wireless connected energy meter



**02963**  
Energy meter for measuring of consumption/production of instant and historical electric energy (hourly, daily, monthly and in the year mode), 1 input for supplied toroidal current sensor, detectable power 25 W-100 kW, single-phase power supply 100-240 V 50/60 Hz, Bluetooth® wireless technology 5.0 for View Wireless mesh system, occupies 1 17,5 mm module

View Wireless connected access control system



**20462**  
NFC/RFID smart card outdoor reader, card configuration using View Wireless app, Bluetooth technology standard, IoT technology on Bluetooth® wireless technology 5.0 standard for the creation of View Wireless mesh system, 1 relay output NO 16 A 100-240 V~ 50/60 Hz, 1 DND input, LED with brightness control, 100-240 V~ 50/60 Hz power supply, grey - 2 modules. Depth: 32 mm



**19462**  
NFC/RFID smart card outdoor reader, card configuration using View Wireless app, Bluetooth technology standard, IoT technology on Bluetooth® wireless technology 5.0 standard for the creation of View Wireless mesh system, 1 relay output NO 16 A 100-240 V~ 50/60 Hz, 1 DND input, LED with brightness control, 100-240 V~ 50/60 Hz power supply, grey - 2 modules. Depth: 31,7 mm



**14462**  
NFC/RFID smart card outdoor reader, card configuration using View Wireless app, Bluetooth technology standard, IoT technology on Bluetooth® wireless technology 5.0 standard for the creation of View Wireless mesh system, 1 relay output NO 16 A 100-240 V~ 50/60 Hz, 1 DND input, LED with brightness control, 100-240 V~ 50/60 Hz power supply, white - 2 modules. Depth: 31 mm



**20462.B**  
NFC/RFID smart card outdoor reader, card configuration using View Wireless app, Bluetooth technology standard, IoT technology on Bluetooth® wireless technology 5.0 standard for the creation of View Wireless mesh system, 1 relay output NO 16 A 100-240 V~ 50/60 Hz, 1 DND input, LED with brightness control, 100-240 V~ 50/60 Hz power supply, white - 2 modules. Depth: 32 mm



**19462.B**  
NFC/RFID smart card outdoor reader, card configuration using View Wireless app, Bluetooth technology standard, IoT technology on Bluetooth® wireless technology 5.0 standard for the creation of View Wireless mesh system, 1 relay output NO 16 A 100-240 V~ 50/60 Hz, 1 DND input, LED with brightness control, 100-240 V~ 50/60 Hz power supply, white - 2 modules. Depth: 31,7 mm



**14462.SL**  
NFC/RFID smart card outdoor reader, card configuration using View Wireless app, Bluetooth technology standard, IoT technology on Bluetooth® wireless technology 5.0 standard for the creation of View Wireless mesh system, 1 relay output NO 16 A 100-240 V~ 50/60 Hz, 1 DND input, LED with brightness control, 100-240 V~ 50/60 Hz power supply, Silver - 2 modules. Depth: 31 mm



**20462.N**  
NFC/RFID smart card outdoor reader, card configuration using View Wireless app, Bluetooth technology standard, IoT technology on Bluetooth® wireless technology 5.0 standard for the creation of View Wireless mesh system, 1 relay output NO 16 A 100-240 V~ 50/60 Hz, 1 DND input, LED with brightness control, 100-240 V~ 50/60 Hz power supply, Next - 2 modules. Depth: 32 mm



**19462.M**  
NFC/RFID smart card outdoor reader, card configuration using View Wireless app, Bluetooth technology standard, IoT technology on Bluetooth® wireless technology 5.0 standard for the creation of View Wireless mesh system, 1 relay output NO 16 A 100-240 V~ 50/60 Hz, 1 DND input, LED with brightness control, 100-240 V~ 50/60 Hz power supply, Metal - 2 modules. Depth: 31,7 mm

View Wireless connected access control system



**20467**  
NFC/RFID energy saver card switch for installation inside the room, IoT technology on Bluetooth® wireless technology 5.0 standard for the creation of View Wireless mesh system, 1 relay output NO 16 A 100-240 V~ 50/60 Hz, 1 configurable input, 100-240 V~ 50/60 Hz power supply, grey - 2 modules. Depth: 31 mm



**19467**  
NFC/RFID energy saver card switch for installation inside the room, IoT technology on Bluetooth® wireless technology 5.0 standard for the creation of View Wireless mesh system, 1 relay output NO 16 A 100-240 V~ 50/60 Hz, 1 configurable input, 100-240 V~ 50/60 Hz power supply, grey - 2 modules. Depth: 31 mm



**14467**  
NFC/RFID energy saver card switch for installation inside the room, IoT technology on Bluetooth® wireless technology 5.0 standard for the creation of View Wireless mesh system, 1 relay output NO 16 A 100-240 V~ 50/60 Hz, 1 configurable input, 100-240 V~ 50/60 Hz power supply, white - 2 modules. Depth: 31 mm



**20467.B**  
NFC/RFID energy saver card switch for installation inside the room, IoT technology on Bluetooth® wireless technology 5.0 standard for the creation of View Wireless mesh system, 1 relay output NO 16 A 100-240 V~ 50/60 Hz, 1 configurable input, 100-240 V~ 50/60 Hz power supply, white - 2 modules. Depth: 31 mm



**19467.B**  
NFC/RFID energy saver card switch for installation inside the room, IoT technology on Bluetooth® wireless technology 5.0 standard for the creation of View Wireless mesh system, 1 relay output NO 16 A 100-240 V~ 50/60 Hz, 1 configurable input, 100-240 V~ 50/60 Hz power supply, white - 2 modules. Depth: 31 mm



**14467.SL**  
NFC/RFID energy saver card switch for installation inside the room, IoT technology on Bluetooth® wireless technology 5.0 standard for the creation of View Wireless mesh system, 1 relay output NO 16 A 100-240 V~ 50/60 Hz, 1 configurable input, 100-240 V~ 50/60 Hz power supply, Silver - 2 modules. Depth: 31 mm



**20467.N**  
NFC/RFID energy saver card switch for installation inside the room, IoT technology on Bluetooth® wireless technology 5.0 standard for the creation of View Wireless mesh system, 1 relay output NO 16 A 100-240 V~ 50/60 Hz, 1 configurable input, 100-240 V~ 50/60 Hz power supply, Next - 2 modules. Depth: 31 mm



**19467.M**  
NFC/RFID energy saver card switch for installation inside the room, IoT technology on Bluetooth® wireless technology 5.0 standard for the creation of View Wireless mesh system, 1 relay output NO 16 A 100-240 V~ 50/60 Hz, 1 configurable input, 100-240 V~ 50/60 Hz power supply, Metal - 2 modules. Depth: 31 mm



**01817**  
Mifare transponder card

Index

General introduction

Smart products

View Wireless

**By-me Plus**

Well-contact Plus

Call-way and antibacterial solutions

**By-me Plus**



Introduction	86
System architecture	92
Typical systems	108
Supervision	120
IP gateway and infrastructure devices	121
Control and functions	122
Sound system	130
Temperature control	133
Energy management	135



## By-me Plus: home automation has become smart.

By-me Plus is the connected automation system based on twisted pair cabling and distributed logic, dedicated to providing **full control over lighting, temperature, sound system, curtain and roller shutter automation, the sprinkler system, energy management and multi-zone temperature control**; giving buildings the maximum comfort and energy efficiency.

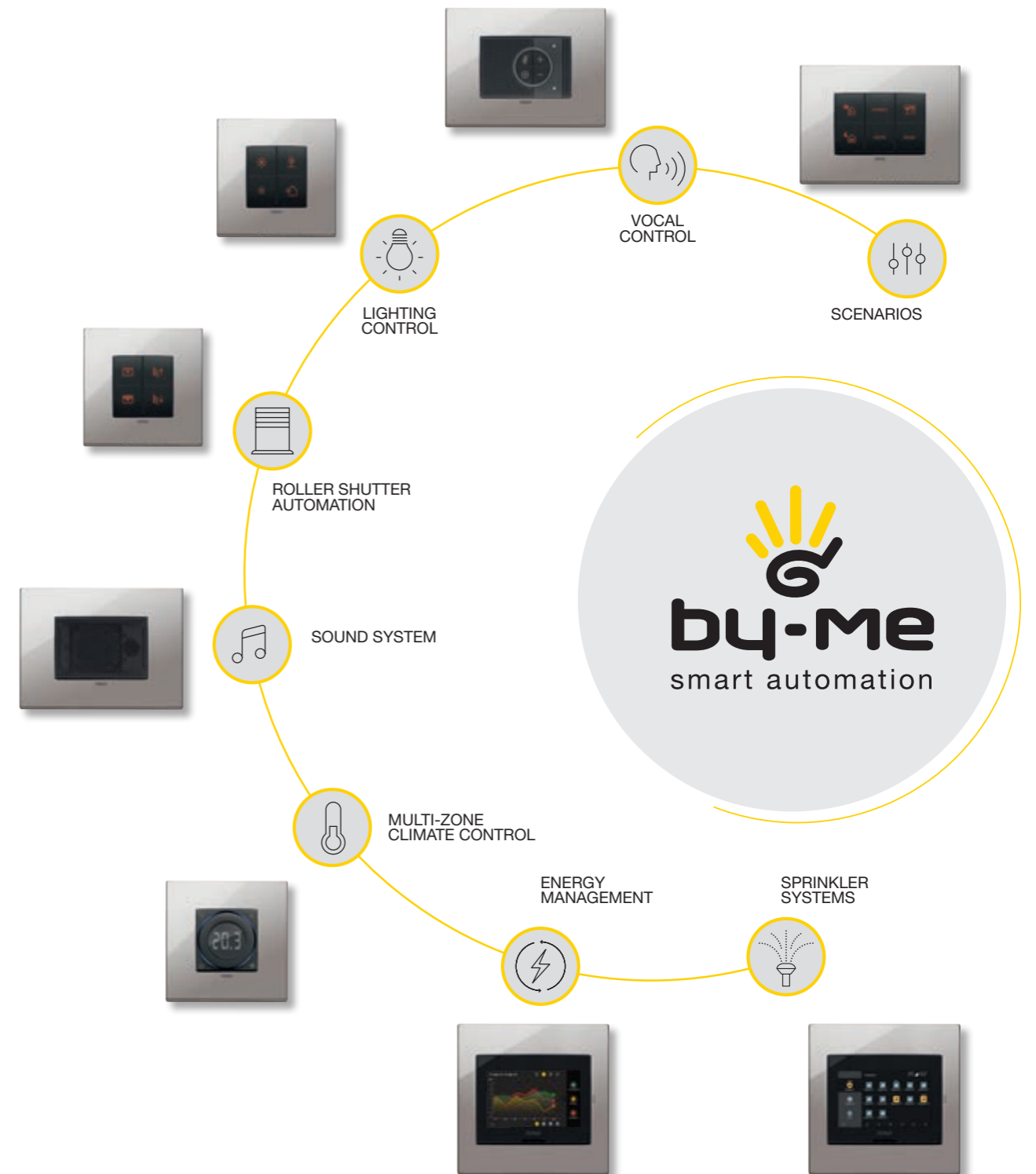

Easier to **install** and **use**.

With **By-me Plus**, the evolution of By-me home automation, the connected system becomes easy to install and maintain, **even remotely thanks to the Vimar Cloud service**.



FOR THE INSTALLER



**THE VIEW PRO APP MAKES YOUR JOB EASIER.**

With the View Pro app, you can programme systems both locally and remotely using a tablet or PC. Indeed, the Cloud service ensures that the devices can be maintained without physically reaching the installation, guaranteeing a service to your customers with the utmost safety and respect for their privacy.



**SMART, FROM INSTALLATION TO MAINTENANCE.**

All the functions and parameters of the By-me Plus system can be configured and customised in a few simple steps. It is then delivered to the end users for their daily supervision and use.

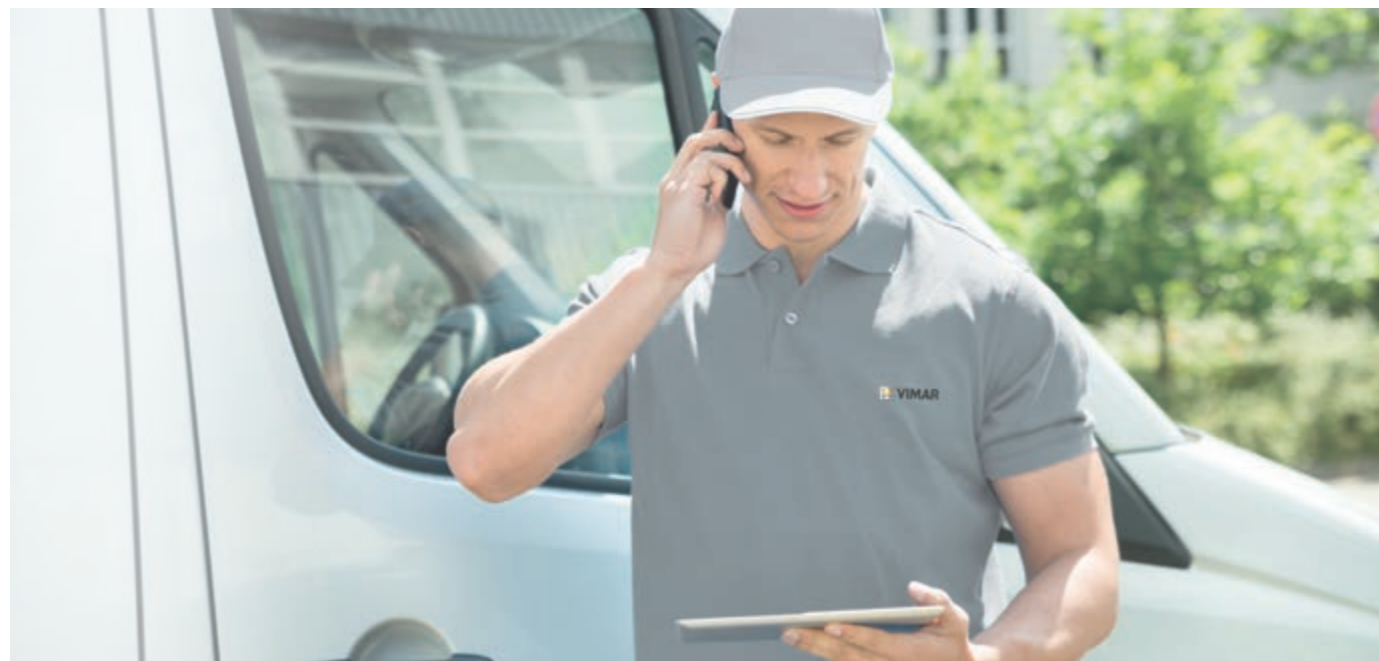

FOR THE USER



**VIEW APP, A SINGLE SUPERVISION APP.**

Routines and scenarios, centralised lighting and roller shutter control, multi-room sound system, burglar alarm system and video door entry control. All accessible through the various digital system interfaces specially developed to guarantee the maximum ergonomic comfort and user-friendliness, even remotely with the View app.



**MORE EFFICIENT ENERGY USE.**

The smart functions of the system exploit renewable sources to cool down or heat the house without affecting consumptions, thus reducing bills by up to 50%.



## Easier, **more functional.**

Compared to a traditional system, connected automation systems give you more functions to control by hand or **with your voice**. A connected home thus guarantees **greater comfort, more efficiency** and **security** both when you are inside the environments as well as when you are out of doors, enhancing the value of the property and **improving life for those who live there.**

### THE OPPORTUNITY OF CONTROL VIAL APP OR VOICE

Controlling your home with touch screen, smartphone, tablet or with your voice makes technology accessible to everyone, including the elderly or the disabled.

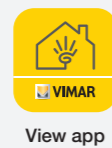

View app

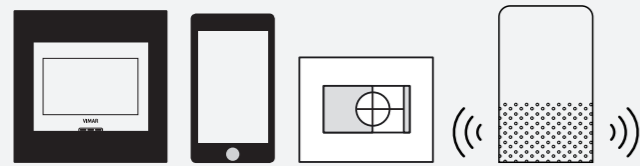

### ALL FUNCTIONS INTEGRATED IN ONE ONLY SYSTEM

Supervising the alarms, opening the access gate by home automation controls, switching on the lighting with sensors, controlling Philips HUE lamps, cooking with IFTTT.

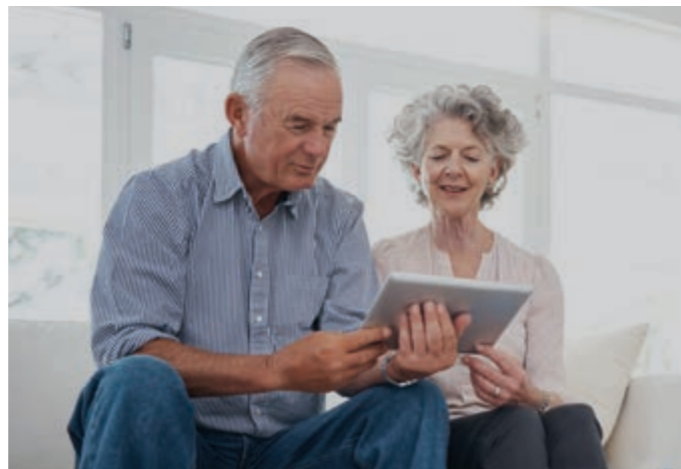
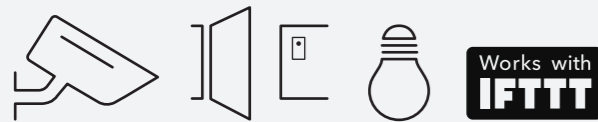

### EXPLOIT PHOTOVOLTAIC SYSTEMS FOR SELF-CONSUMPTION

The system offers smart management of the energy produced by a photovoltaic system, transferring it to previously selected appliances to reduce the amount of power drawn from the mains and support the greatest self-consumption.



### YOUR FAVOURITE SCENARIOS WITH JUST ONE TOUCH

Centralised control to activate one of the customisable scenarios makes the building truly smart. Up to 300 devices can be connected: from turning off lights to managing the temperature and the sprinkler system.

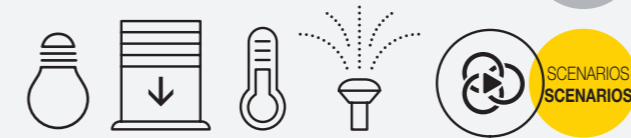

### TEMPERATURE CONTROL, COMFORT AND ENERGY SAVING

Smart thermostats for heating control and climate control for maximum comfort throughout your home, as well as to avoid energy wastage. Many solutions for temperature control system (4-pipe, proportional valves and damp control) and integrated with Mitsubishi, Daikin and LG technologies.

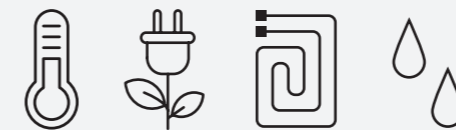

### SOUND SYSTEM

The system offers high-quality management of various sound sources, with different tracks playing in each room (multi-room). Moreover, the Bluetooth receiver can distribute the digital signal from a smartphone or tablet to all environments.

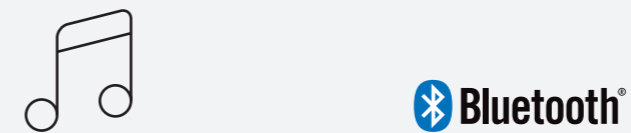

### REDUCE CONSUMPTION TO PREVENT BLACKOUTS

If the contractual draw threshold is exceeded, the system automatically cuts off certain loads according to pre-set priorities in order to prevent a blackout due to overloading.



## System architecture.

By-me Plus is one of the main systems of the VIEW IoT Smart Systems platform. Focused on **comfort** and **energy efficiency**, it enables the user to control and perform the integrated management of the lighting, curtains and roller shutters, temperature and energy control of the building and the multi-room sound system. By-me Plus is easier to programme and maintain thanks to the IP gateway and **View Pro** app. By-me Plus can be programmed both locally and remotely thanks to the support of the Vimar Cloud.

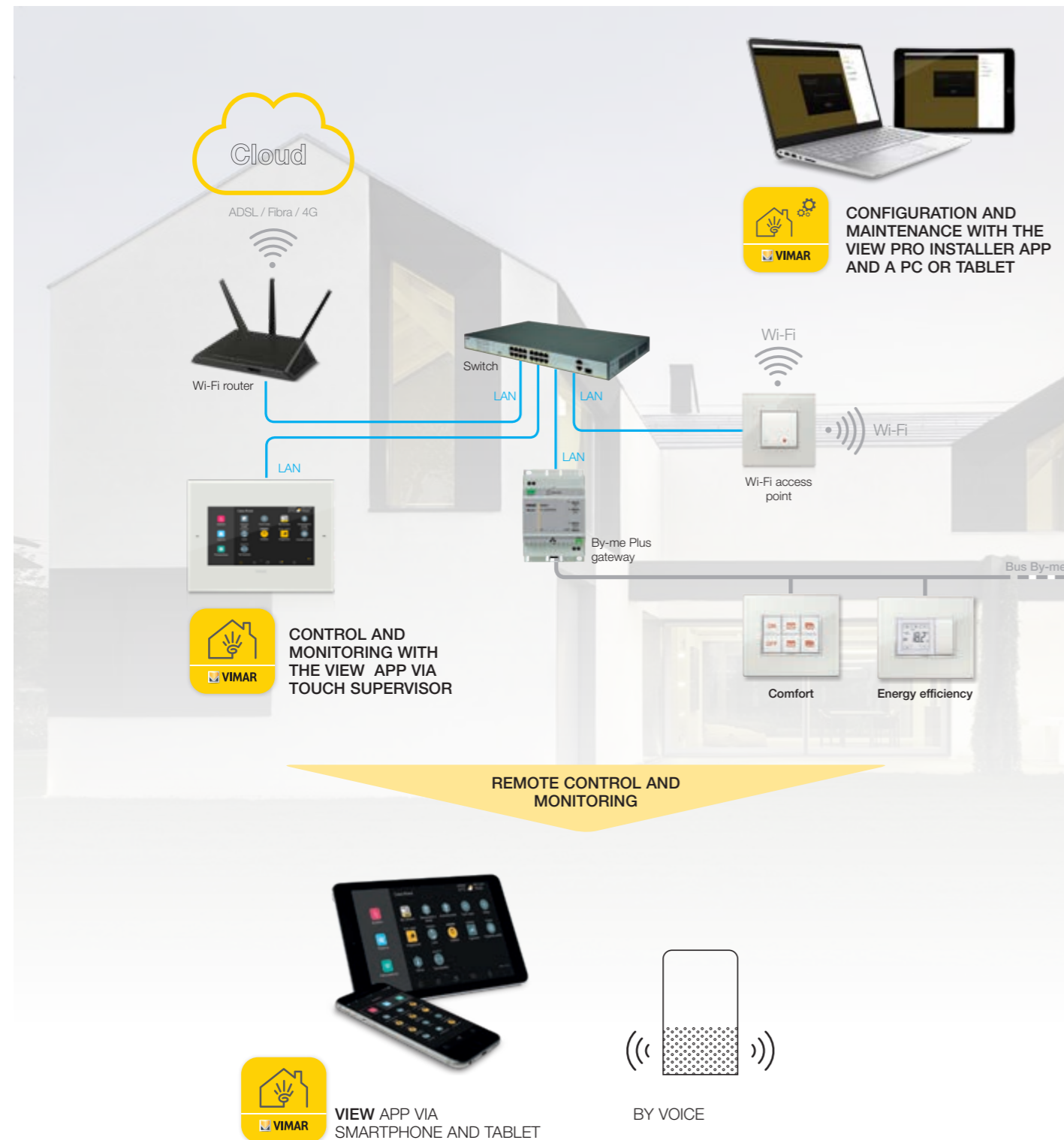

## Devices pre-configured for lights and roller shutters.



**Pre-configured Plug&Play devices** make it easy to create basic home automation systems for roller shutters (supplied in pre-configured kits) and lights (supplied as single devices), and to create dedicated scenarios, ensuring a functional upgrade with little effort and minimal expense for the end customer.



Home automation controls for lighting and roller shutter control, retrofit controls and for DIN rail mounting.

### MORE COMFORT.

Managing the **lighting** and the **sound system**, moving **curtains or roller shutters**, dimming the light of the **various traditional and energy-saving lamps**, or creating games of coloured light. All through **scenarios** pre-set based on the user's requirements. In this way, every space of the home becomes an oasis of wellness in which you can always find your favourite environmental conditions.



Home automation controls for roller shutter control

### CURTAIN AND ROLLER SHUTTER AUTOMATION.

It only takes a small gesture to raise or lower roller shutters and curtains of a room or of the whole home and to handle other automatic functions such as opening or closing the slats. All also within customised **scenarios** that can easily be recalled using a single switch.





**LIGHT DIMMING.**

Dim the lighting to suit your own personal preferences by managing any type of lamp: incandescent, fluorescent, LED, energy saving, Philips Hue and DALI/DALI2 with the option of decorating environments with coloured light effects.

The laser-engraved symbols clearly identify the function and all the lights throughout the home can be turned off with a single control.



Home automation controls for light control

**SOUND SYSTEM.**

The system manages up to four different sound sources and enables users to set different listening experiences for each environment: classical music in the living room, the latest pop hit in the kitchen or the radio in the bedroom. This means that each environment can have its own music – including from a smartphone via Bluetooth streaming – with excellent sound reproduction quality due to the digital carrier signal and high speaker quality. Single or multi-channel sound systems capable of emitting a high quality sound signal can be created using up to 4 sound sources simultaneously in several environments. The sound system functions can be included in (programmed) scenarios and events of the By-me Plus system (for example radio clock alarm function).



3-Module flush mounting speaker.

**ENERGY EFFICIENCY.**

Managing energy more responsibly with evolved solutions capable of optimising the consumptions without losing out on quality, generating **savings of up to 50%** (according to a study performed by Milan Polytechnic University, IoT Observatory and in line with the EN15232 standard).

**Management of the loads** to prevent blackouts due to overloading and smart distribution of solar energy.

Thanks to the possibility of viewing the consumptions, also remotely using the App, the user will always and promptly be aware of the energy profile of the home.

**Comfortable climate control**, home energy supervision with measurement and viewing of consumptions (including non-digital ones).



IP touch screen. 4.3" PoE with "energy management" function.



IP 10" PoE touch screen with simplified and intuitive "Climate control programming" function.

**ENERGY MANAGEMENT AND OPTIMISATION.**

Smart management of the energy produced by a photovoltaic system that is automatically carried on the appliances already selected, thus reducing the amount of power used from the network and favouring maximum self-consumption.

In case the contractual withdrawal threshold is exceeded the system automatically cuts off certain loads, based on pre-set priorities, preventing the occurrence of a blackout due to overloading.

**TEMPERATURE CONTROL AND COMFORTABLE CLIMATE CONTROL.**

Home automation heating and cooling systems which can be controlled either for each individual room, by way of elegant thermostats or flush mounting electronic probes, and/or from a single point.

Ideal for any type of temperature control system (floor, with radiators, fan-coil or split systems), enable optimum climate control management, reducing waste, notifying when the optimum consumption values are exceeded and guaranteeing maximum environmental comfort also using pre-set scenarios that can easily be recalled.



Load control



Dial thermostat



Electronic temperature and humidity sensors

**BY-ME PLUS IS EASY INSTALLATION.**

The main characteristic of the By-me Plus system is that all the devices are interconnected by a **wire for Bus systems** (double pair - Fig. 1) which sends both the power supply and the signal with digital command and control messages to these.

A **Bus line** must be powered with 1 or 2 power supply units (according to the absorption of the installed devices and the length of the power cable - Fig. 2) and can be composed of a maximum of 128 devices. The devices can be connected in any order: **linear, star or combined topologies** (Fig. 3).

The system enables a structure composed of **16 lines**, each with a maximum of **128 devices** (Fig. 4). The lines are connected with one another by way of couplers (routers) that only allow the passage of the messages established at the time of programming the system.

**Devices and distances by line**

Dimension of logic of By-me Plus gateway (number of devices)	32 for item 01410, 300 for item 01411
Max distance between power supply unit and last device	350 m
Max total distance of the Bus line	1.000 m
Max distance between two devices	700 m
Minimum distance between two power supply units	40 m (the loads must be balanced between the two power supply units)
Optimum position of a single power supply unit	In the centre of the Bus line
Optimum position of two power supply units	At the ends of the Bus line
Minimum voltage on the furthest device	23 Vdc (in stand-by mode)

**NOTE:** The optimum configuration is that with the power supply units placed as far away as possible from one another to have a positive effect on the minimum voltage present on the Bus.

Fig. 2 - Max Bus line length

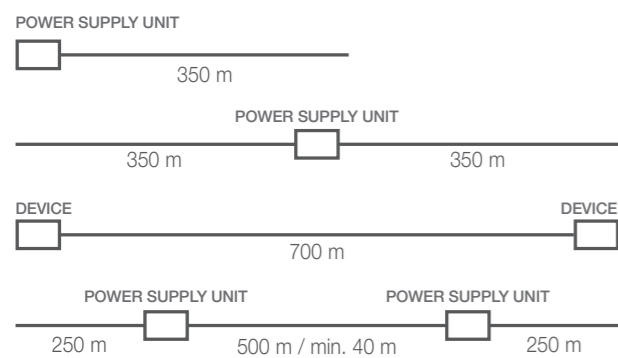

Fig. 3 - Installation topologies of a line

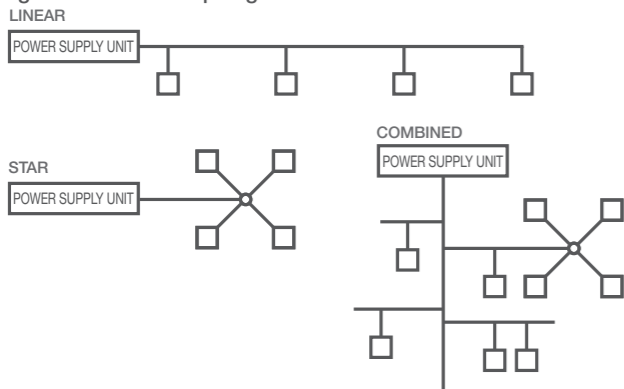

Fig. 1 - Connection of the Bus wire

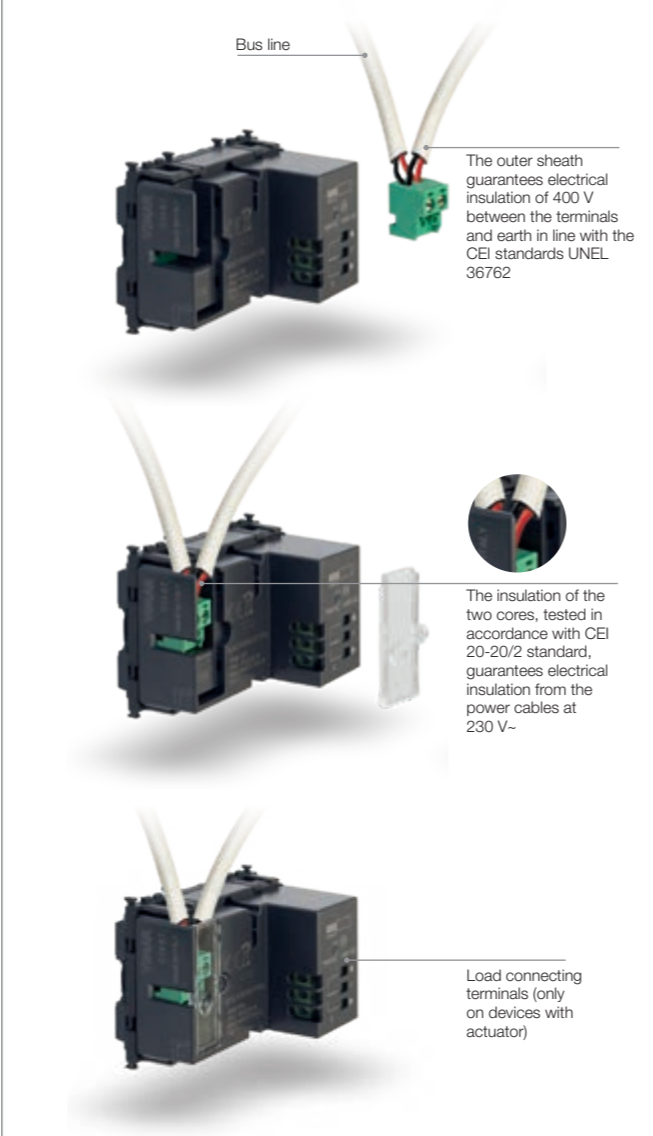
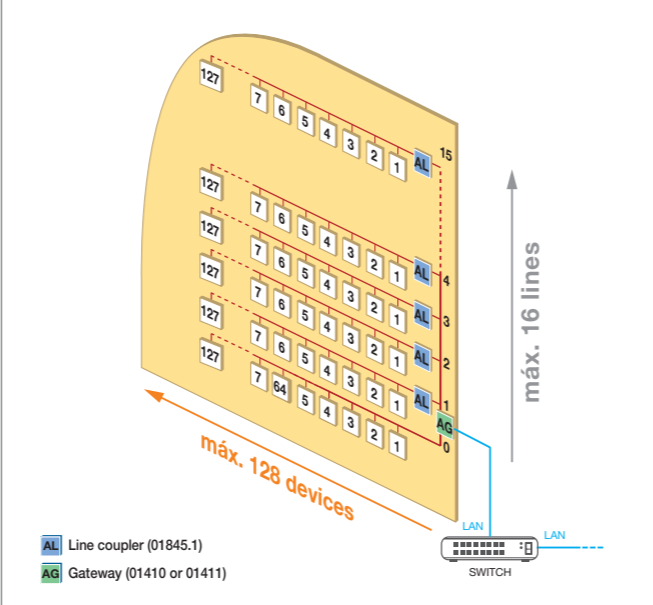

Fig. 4 - Division into Areas and Lines



**Max number of configurable gateway and touch screens for single system**

Home automation gateway art. 01410 or 01411	max 1
Burglar alarm system gateway art. 01712.1	max 1
Video entry system gateway art. 01415 or 01416	max 1
Touch screen art. 01420, 01422 or 01425	max 20 of which 10 can be enabled to manage video door entry system calls

**NOTE:** The remote control of video door entry system calls can be realized by max 3 mobile devices. The list of matchable devices with home automation gateway is available on [www.vimar.com](http://www.vimar.com), section Download/AppMobile/VIEW Pro.

The By-me Plus system works based on the **distributed logic** dividing its intelligence among all the devices of the system and configuring its functional links. These links are obtained by creating "**applications**" containing the **functional units** of the various devices.

**Functional unit:** this is part of a physical device that can be managed as an independent device (Fig. 5-8).

**Application:** a set of interconnected homogeneous functional units (only lighting control or only roller shutter control) that carry out a function in the system (for example three different buttons that control a single actuator and therefore the same load - see Fig. 7). **The devices of which an application is composed are interconnected logically and not in line with a traditional wiring system.**

During the design phase, every functional unit of every device must be considered as an independent function. Therefore, in the design phase, the functions to be created are envisaged in advance and the list of the devices that will have to activate these will only be prepared subsequently.

For example, during installation, the actuator could be used to control load A via the key of another device, the left, central and right hand buttons to control loads B, C and D via the actuator for rail mounting (Fig. 8).

There are no constraints on the functional units of a physical device. When a load has to be controlled, a device (switch or IP PoE touch screen) and an actuator connected to the load must be envisaged.

Fig. 7 - Example of Application

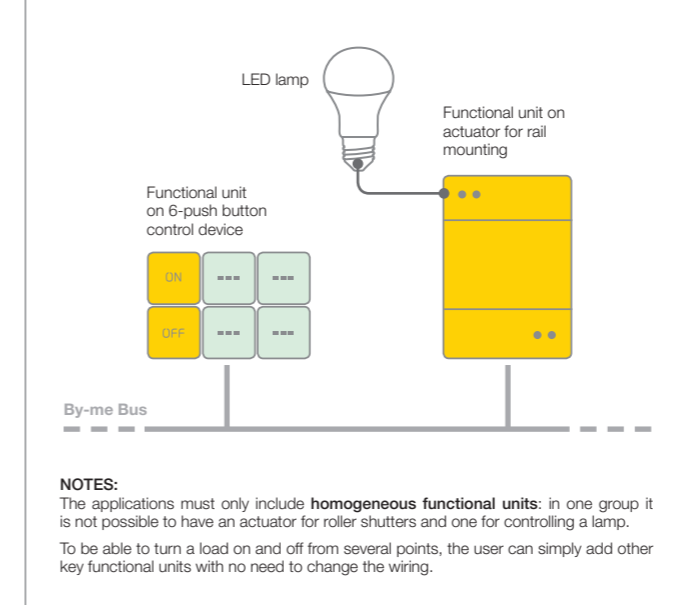

**NOTES:** The applications must only include **homogeneous functional units**: in one group it is not possible to have an actuator for roller shutters and one for controlling a lamp. To be able to turn a load on and off from several points, the user can simply add other key functional units with no need to change the wiring.

Fig. 5 - Example of 10 functional units on 6-push button control device and on-board actuator.

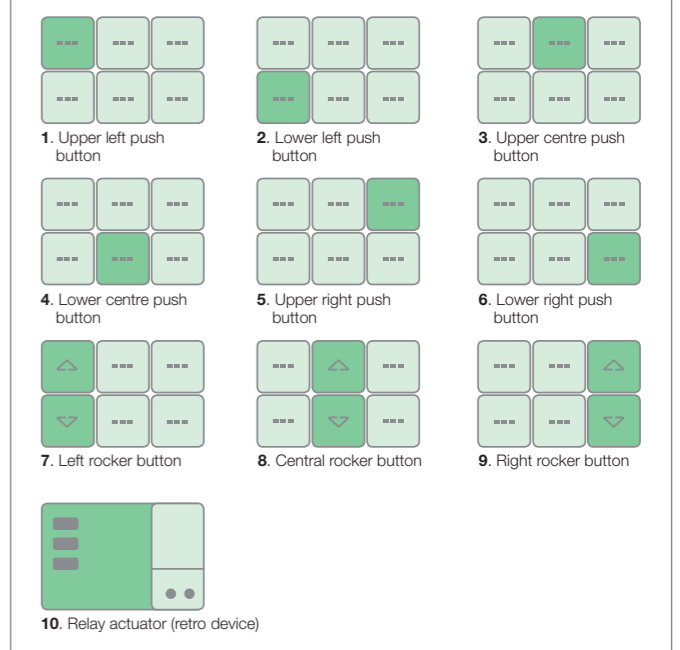

Fig. 6 - 2 and 3-module control devices to be completed with 1 and 2-module keys. Every key is a functional unit

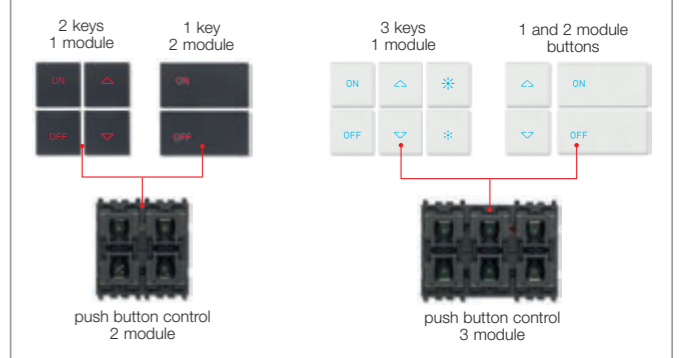
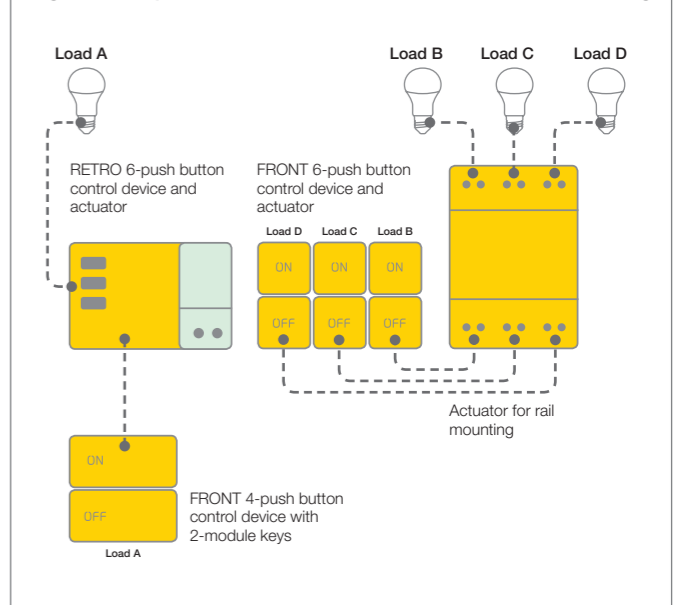

Fig. 8 - Example of Functional units with actuator for rail mounting



**BY-ME PLUS IS SIMPLE CONFIGURATION.**

The By-me Plus system is configured using the **VIEW Pro** app, by connecting to the home automation gateways (items 01410 or 01411) via LAN network or Wi-Fi.

Via the **VIEW Pro app** users can:

- create the topology of the building;
- list the devices of the By-me Bus;
- configure the applications of the system;
- integrate the different subsystems;
- enable the integration with third party systems.

The devices can be configured **On-line**, directly connected to the wired and installed system.

The **VIEW Pro** app also enables the maintenance of the gateways and the diagnostics of the Bus devices.

In relation to the commissioning of the system, bear in mind that:

- **building topology**: the plan of how the environments are divided which will then be used for viewing the user interface on the IP PoE touch screens or on the **VIEW** app;

- **device listing**: the operation that entails pressing once on the configurations of the Bus devices, so that they can be assigned with an unequivocal physical address;
- **application configuration**: the definition and the configuration of the parameters of the logical connection between controls, thermostats, probes, sensors and actuators;
- **integration between subsystems**: enables a relationship to be created between different system devices, for example a sensor of the alarm system turns on a light or activates the video camera associated with the alarmed area, or a home automation control opens the gate using the output of the Due Fili Plus external entrance panel;
- **integration with third party systems** : enables the resources provided by other systems to be configured in the applications for the end user, such as Philips Hue, the Google and Alexa smart speakers or KNX systems.

**NOTE.** *The gateway does not require an Internet connection for the configuration process. The only action that requires the installer to be connected is the first Login in the VIEW Pro app.*

Programming of the **logic programmes with Editor** (this requires connection to the Cloud): this tool enables the logic programmes that typically receive one or more pieces of information from the By-me Bus to be created (= **inputs**), develops them using logic units (= **logics**), and sends the results in the form of controls on to the Bus (= **outputs**).

**Input.** These can be:

- the statuses of the devices listed in the system, with no restrictions;
- instants or time intervals (day, week, etc.);
- Boolean or numerical variables.

**Logics.** These can be:

- combinatory logics (**and, or, not, xor**);
- sequential performers (**sequencer, binary scenario, numeric scenario**);
- status logs (**T type, or RS type flip flop**);
- comparison operators (**more than, more than or equal to, less than, less than or equal to, equal to, different from**);
- operations (**maximum, minimum, average, sum, subtraction, multiplication, division, absolute value**);
- time delays and hourly programming.

**Outputs.** These can be:

- the status of the devices enrolled in the system, without any limitation;
- Boolean or numerical variables.

The programming occurs via the **VIEW Pro** app, using **the editor of the logics only via Cloud** as they are faster, always updated and with sufficient space to save the copies of the programmes. The home automation gateways (items 01410 - 01411) are also equipped with the *Logic Unit function* with the possibility of also using non By-me and/or KNX products in the logics (while **item 01468 only manages By-me and/or KNX objects**).

The logics contained in the gateways can be managed from the user interface, whereas those of Logical Unit 01468 cannot.

The By-me units are depicted graphically as per the example in Fig. 5 and are characterised by their yellow background colour. In the case of the By-me units, the input nodes enable controls to be sent to the Bus following the processing carried out in the logic programmes; the output nodes receive the statuses from the Bus and use them in the logic programmes; the available nodes depend on the type of By-me group.

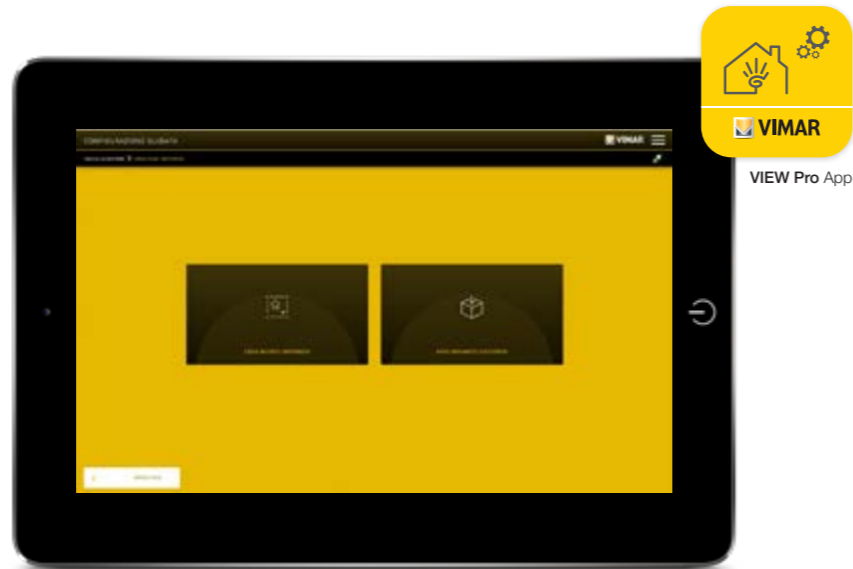

"Guided configuration" screen of the **VIEW Pro** app for creating a new system.



"Device listing" screen of the **VIEW Pro** app



"Application details" screen of the **VIEW Pro** app

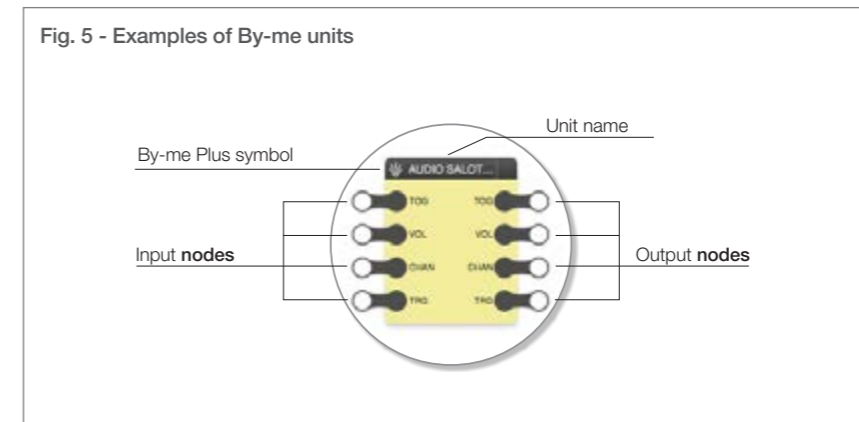
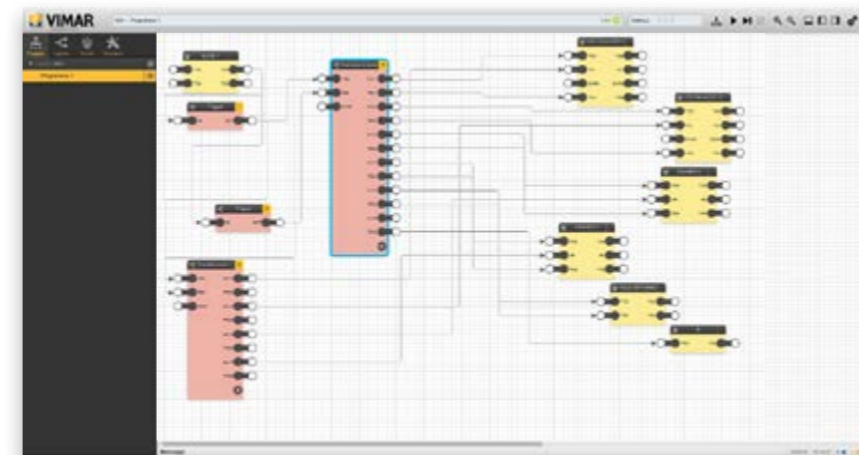

Fig. 5 - Examples of By-me units



"Logic program editors" screen of the **VIEW Pro** app.

**BY-ME PLUS IS SIMPLE MAINTENANCE.**

The installer can access the system remotely by connecting to the Vimar Cloud in order to make **changes to the configuration, firmware updates, diagnostics** on the individual devices and to **backup** the settings on Cloud.

It is easy to access the list of the installed systems and manage them, receiving notifications about particular established conditions (breakdowns, availability of updates).

The maintenance activity is supported by useful functions, including:

**Diagnostics:** this verifies whether the data present on the various devices corresponds with those set in the applications, comparing the configuration of the devices present on the Bus and the contents of the database.

**Bus monitor:** this views the data that transit on the By-me Bus to monitor their activity and analyse particular device configuration conditions. It helps resolve the problems detected during the diagnostic scan and enables the configuration to be corrected.

**System log:** this memorises all the operations performed on the system via the gateway; this view can be filtered by level and category by selecting those desired with a tick.

**Device reset:** this restores the factory settings of the device without removing them from the system.

All the maintenance operations of the By-me Plus system are performed using the **VIEW Pro** app.

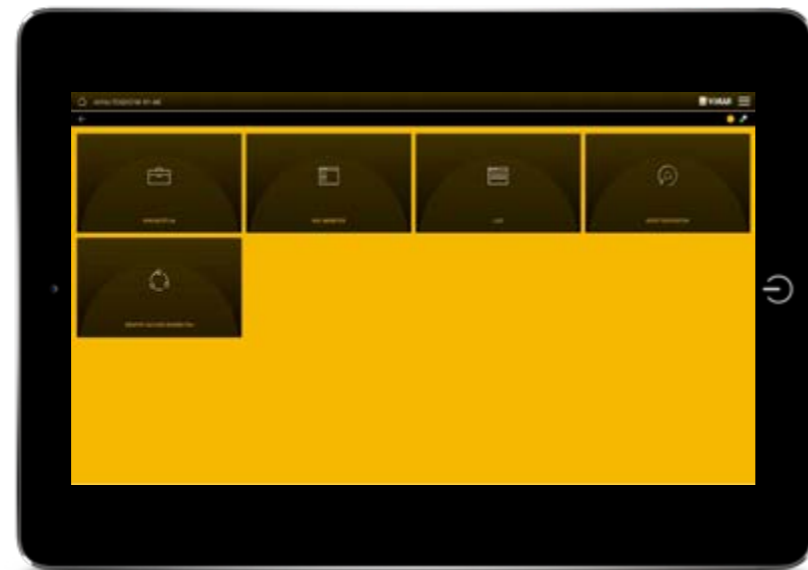

"Maintenance" screen of the **VIEW Pro** app.



**VIEW Pro** app for the installer

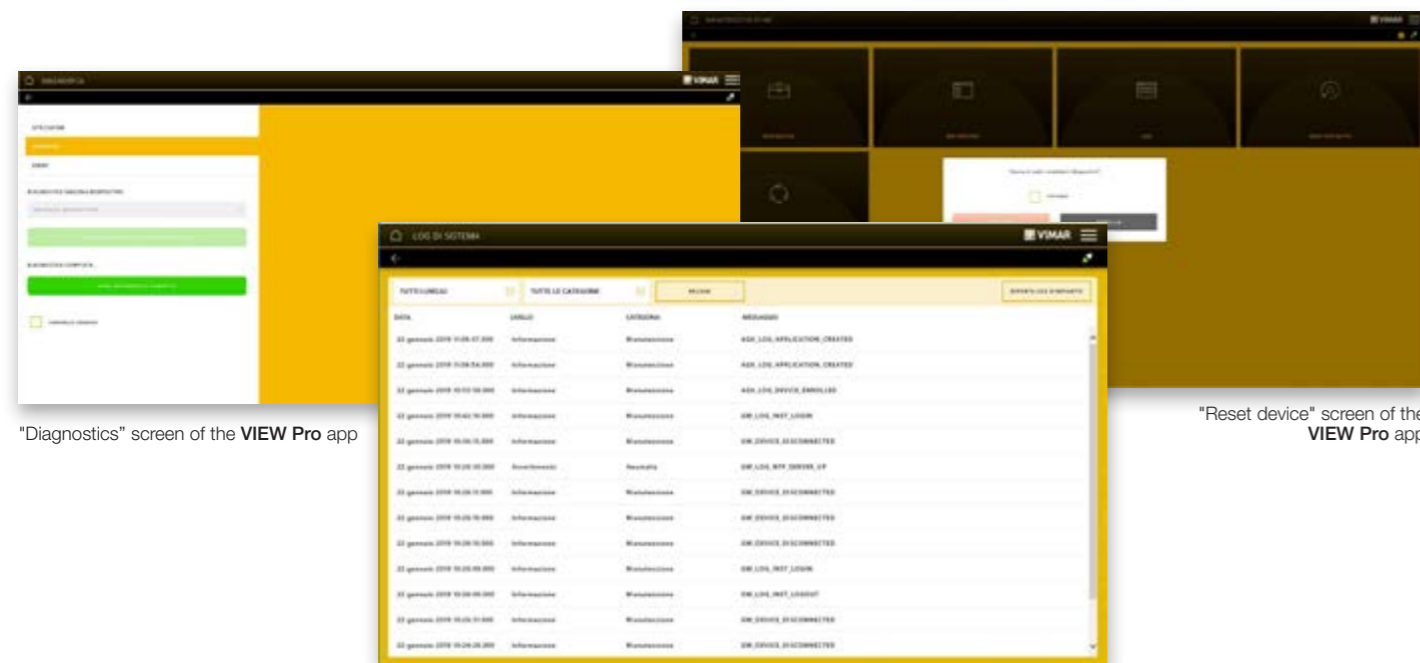

"Diagnostics" screen of the **VIEW Pro** app

"Reset device" screen of the **VIEW Pro** app

"System log" screen of the **VIEW Pro** app

**BY-ME PLUS IS USER-FRIENDLINESS.**

Once the By-me Plus system has been appropriately organised and programmed, it is ready for to be used by the end user, who can control the system using the **VIEW** app.

The app, which can be downloaded free from the Google, Apple and Windows stores and, thanks to a simple user experience, makes all the information about the By-me Plus system readily available.

Whether you use a smartphone, a tablet or the IP touch screens, the interfaces and the icons viewed are always the same.

Additionally, by way of the "drag&drop" function, the Home screen can be customised with the most frequently used functions and elements so that these can be selected directly without accessing the menus. The background can also be changed to display images already present on the device or with newly uploaded ones.

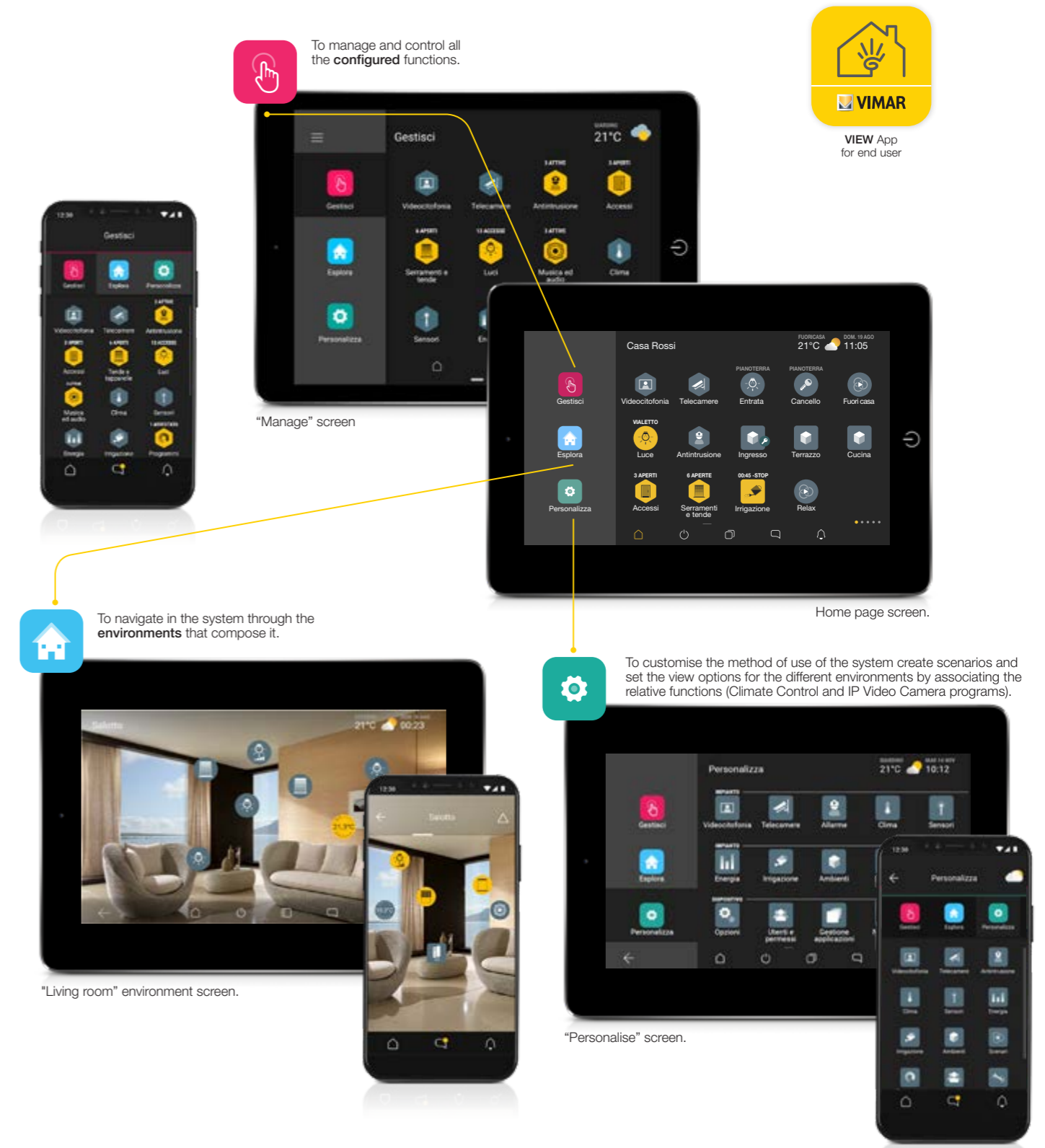

To manage and control all the **configured** functions.

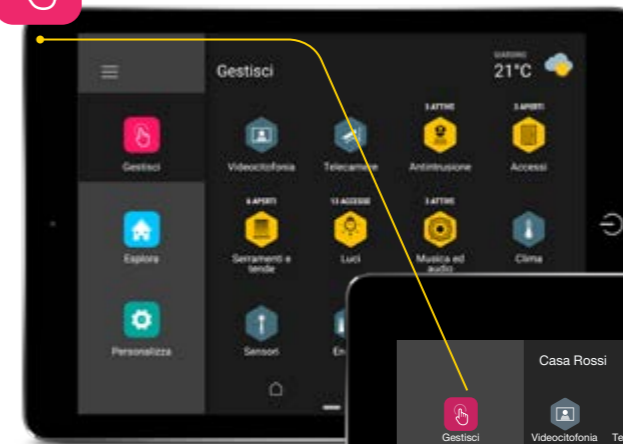

"Manage" screen



**VIEW** App for end user

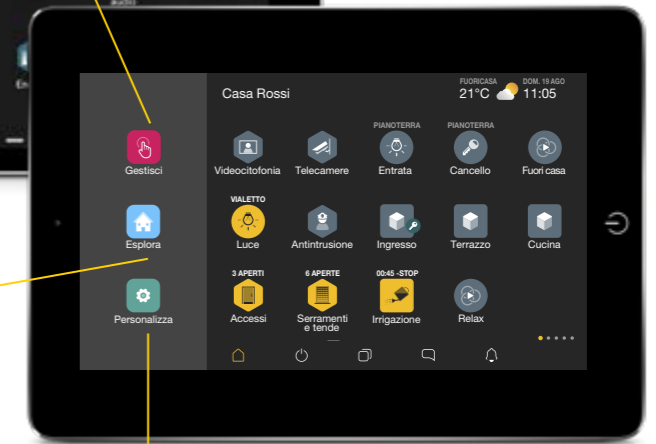

Home page screen.

To navigate in the system through the **environments** that compose it.

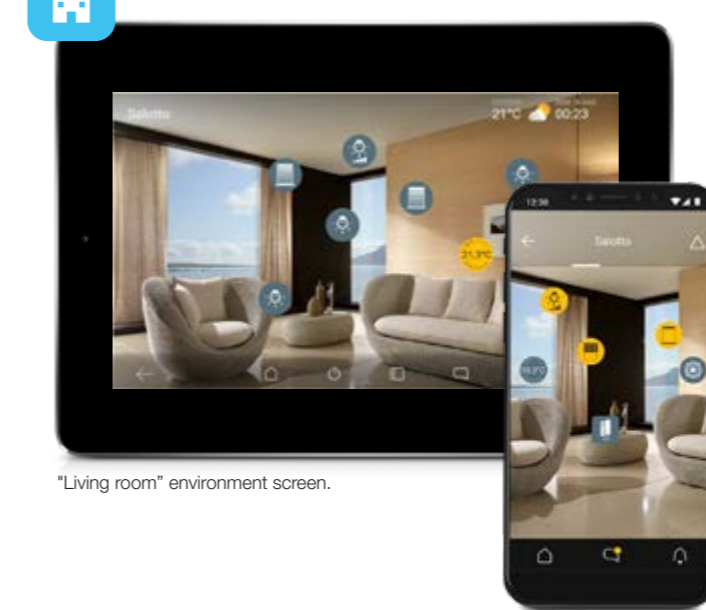

"Living room" environment screen.

To customise the method of use of the system create scenarios and set the view options for the different environments by associating the relative functions (Climate Control and IP Video Camera programs).

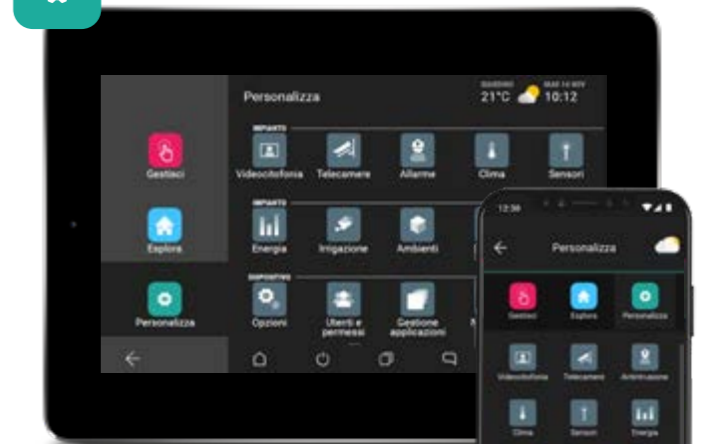

"Personalise" screen.

The system enables the user to create **scenarios**, and when these are activated a number of pre-established conditions (lights on/off, dimmed lights, roller shutters up/down, climate control on/off, etc.); the sequential activation of these creates a particular environment or meets a specific condition.

By creating **events**, the system enables the user to manage automated functions at a certain time or when specific conditions come into play.

**Scenario:** this is the function that enables the user to “recall” a desired condition using a single control or event; creating a scenario is very simple and the user can do so using the guided **Wizard** of the **VIEW** app.

The user can also link a scenario to a physical control present in the system, specifically pre-configured by the installer using **VIEW Pro**.

**Event:** this is a program that activates/deactivates applications and/or scenarios in certain conditions and/or at programmed times according to certain logics.

It is **configured by the installer**, whereas any **time settings** are **managed directly by the user**.

**Logic programme:** this is a programme configured by the installer that aggregates various devices to create more complex

functions, also by using logical operators (AND/OR), comparison operators (<,>) and other usable resources, such as time settings (which can be changed directly by the user).

The logic program can be resident in the home automation gateways or downloaded in the **Logic Unit** (item 01468).

By-me Plus has not limit to the scenarios number; as regards the **simplified logics** (e.g. irrigation and periodical timing) the max number of applications is **16**, while the **logic programs** for each device (home automation gateway or Logic Unit) are **64**.

Accordingly, multiple actions can be programmed to take place at a given time, for example: when getting up in the morning, the light switches on at a selected dimmer setting, the sound system comes on, the roller shutter is raised and the towel rail warms up in the bathroom.

Using the Logical Unit, the user can:

- create variously organized relationships between blocks of the By-me system, setting them in relation via logic gates, delay blocks and mathematical functions;
- define **virtual scenarios**;
- define action plans (“timelines”), with different types of frequency, duration, validity periods, etc.

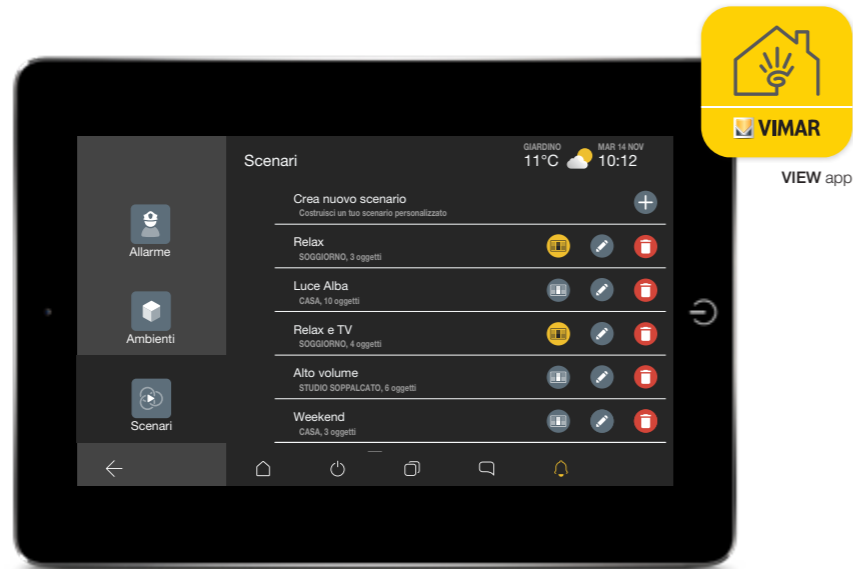

“Scenario” VIEW app screen.

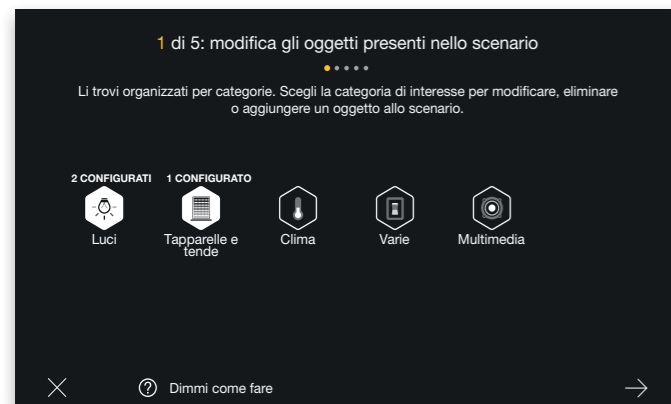

“Change objects in the scenario” VIEW app screen.



“Summary of Relax scenario” VIEW app screen.

**BY-ME PLUS INTEGRATION WITH DUE FILI PLUS AND IP ELVOX DOOR ENTRY.**

The video door entry system, both with Due Fili Plus and IP technology, is intrinsically integrated into the **VIEW IoT Smart Systems** platform of Vimar, thanks to the presence of certain specific gateways (item 01415 for Due Fili Plus technology and item 01416 for IP technology).

On new systems the integration consists in using the new IP 4.3”, 7” and 10” touch screens as internal video door entry systems and as supervisors of all the function installed in the View system. At the same time, the mobile devices also become “virtual” indoor stations capable of making intercom calls and of establishing a dialogue with the video entrance panel both locally and remotely, for all the functions envisaged also by the fixed stations (video streaming, gate opening, turning on, activating the answering machine etc.).

The connectivity with the **Cloud**, as well as supervising the system remotely, also allows the user to use the push notifications providing information about specific events, and the installer to update firmware/software and diagnostics also remotely.

The integration does not only involve sharing the user interface but is deeply rooted in the various devices of the subsystems,

enabling functions that would otherwise not be usable to be created for a situation based on all-round comfort.

Below are some integration examples:

- the cameras of the video door entry system can be associated with areas of the By-alarm burglar alarm system (if present) to enable a video check to be performed if the alarm goes off;
- the controls of the By-me Plus system can be used to activate the relays of the video door entry system, to open locks or control external lighting;
- from a video door entry call, the user can activate a scenario involving the devices of the By-me Plus system, for example to turn on an outside light or turn off the sound system for a few seconds until the call is active.

The use of the video door entry gateways on the existing systems means that the latter can be used, simply adding the function that enables the user to manage the call remotely on mobile devices and all the services connected to the Cloud.

Example of integration of the By-me Plus system with Elvox Due Fili Plus or IP video door entry system.

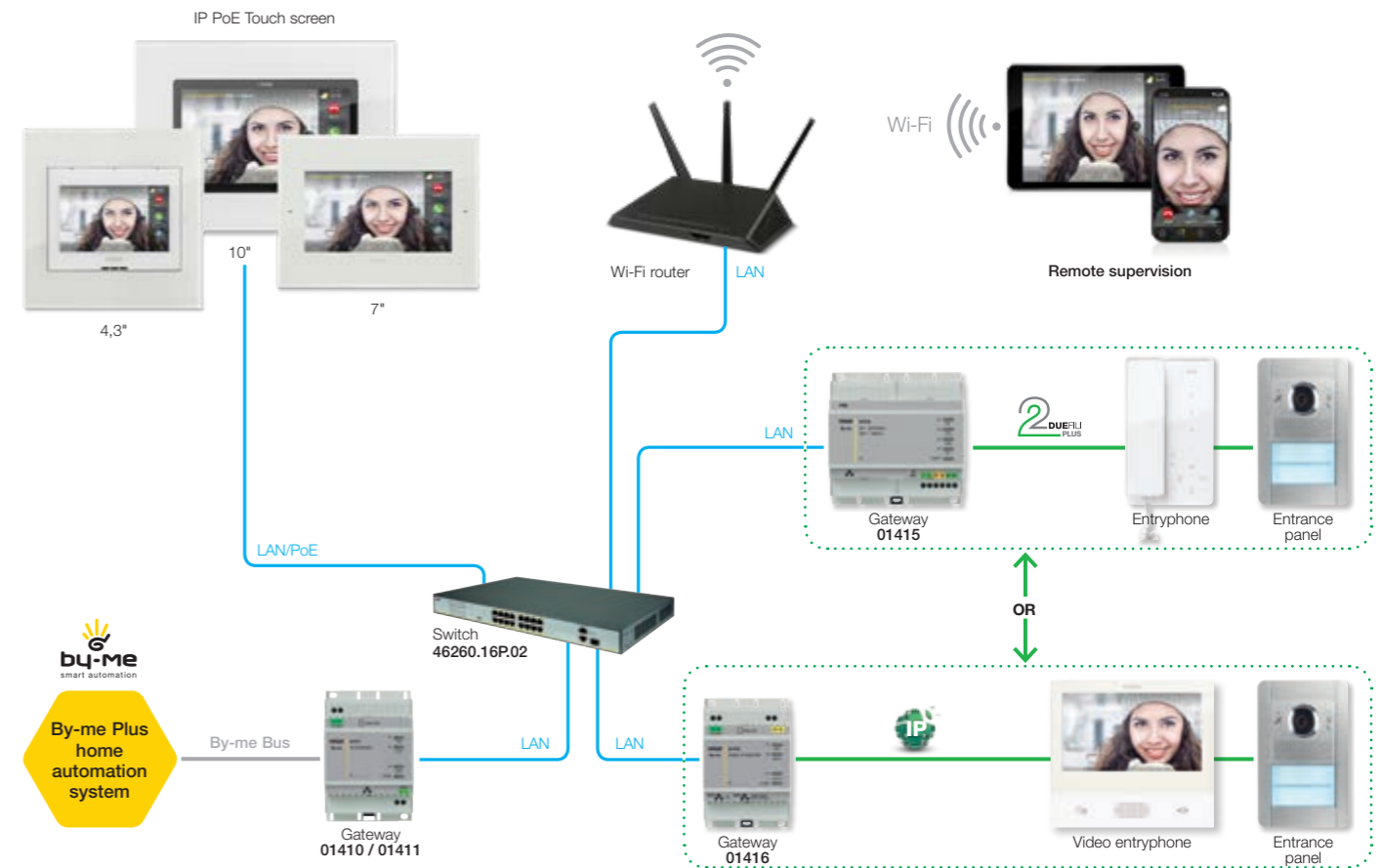

**BY-ALARM BURGLAR ALARM SYSTEM.**

The By-alarm burglar alarm system is integrated by connecting the burglar alarm system control units (items 01700 - 01703) to the IP network via the gateway (item 01712.1) which uses an encrypted communication protocol with an extra-high security level.

The gateway allows the installer to access the system (also remotely) through a secure communication channel, using the **By-alarm Manager software** version 2.0.

The **integration functions** are:

- control and management of the By-alarm system from IP PoE touch screens (01425, 01422, 01420) to see the system status (connection/disconnection of the areas based on the rights of the user PIN entered and see events/alarms, etc.);
- light control: using the dual technology sensors, you can control the By-me light sets when the relative zones are disconnected;
- use of window sensors to send the stand-by command to the By-me thermostats;
- activation of a By-me scenario upon the occurrence of an event (connection, disconnection, alarms, etc.) in the burglar alarm system;
- use of logic programs linked to the status of the areas (full connection, partial connection, alarm);
- videocheck with view of all the analogue and IP cameras and those installed on the video door entry risers by the supervisors or mobile devices.



4,3 "IP PoE touch screen

**VIDEO SURVEILLANCE WITH ELVOX CCTV.**

The **CCTV** video surveillance system, **analog AHD or digital IP technology**, natively integrates into the VIEW IoT Smart Systems platform, without using specific gateway (if uses DVR for AHD cams, required Firmware 1.2.6 or next).

The integration enables, for IP stand-alone cams (not connected to DVR/NVR) and for IP/AHD cams connected to NVR/DVR, the visualization of streaming live. These functions are available both local and remote by means the View app. In order to manage by the touch screens all the control functions of DVR/NVR, it is possible to activate on the Customise/Application management menu of View app the By-camera "L" (landscape) function that is the same of By-camera app, available only for mobile devices.

The integration is not only the sharing of the same user interface but also sharing between the different systems, for ex. the cams of CCTV system can be associated to the By-alarm burglar alarm system zones to enable the **videocontrol in case of activated alarm**. This is thanks to a complete comfort.



IP 10" PoE touch screen

**BY-ME PLUS IS INTEGRATION WITH THIRD-PARTY SYSTEMS.**

**INTEGRATION WITH DALI SYSTEM.**

DALI technology natively integrated into By-me Plus by means DALI actuator (art. 01419.1) and home automation gateway (art. 01410 or 01411), which supervises scenarios and controls of By-me Plus.

The DALI gateway, working as "controller", self-addresses the control of the DALI lamps without using special tool.

It is possible managing **until to 64 DALI lamps**, controllable directly from By-me Plus devices and in lighting scenarios.

The **compatibility with new DALI 2.0 standard** enables to manage the light temperature and the dynamic white, this functions are enjoyed for realizing comfort during the day or for calibrate the light temperature of different lighting fittings to harmonise the lighting in the environments.

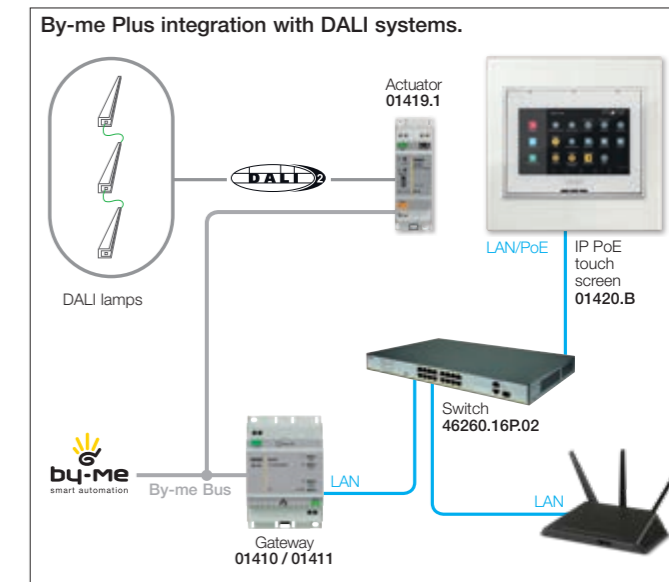

**ENOCEAN® STANDARD RADIOFREQUENCY EXTENSION.**

The radiofrequency controls work without a battery and do not require wiring making them particularly useful in renovations and the functional extensions of an existing system. The technological heart of the controls is an electronic module capable of exploiting the energy generated by the pressure of the keys to send the commands in wireless mode using the EnOcean® protocol used in the IoT environment.

The **EnOcean® technology** can also be perfectly integrated with the By-me Plus home automation system, since the system can be extended to all areas where it is not convenient or it is impossible to carry out masonry work, thus reducing installation and maintenance costs and saving a considerable amount of energy.



**Example of integration of the By-me Plus system with radiofrequency controls.**

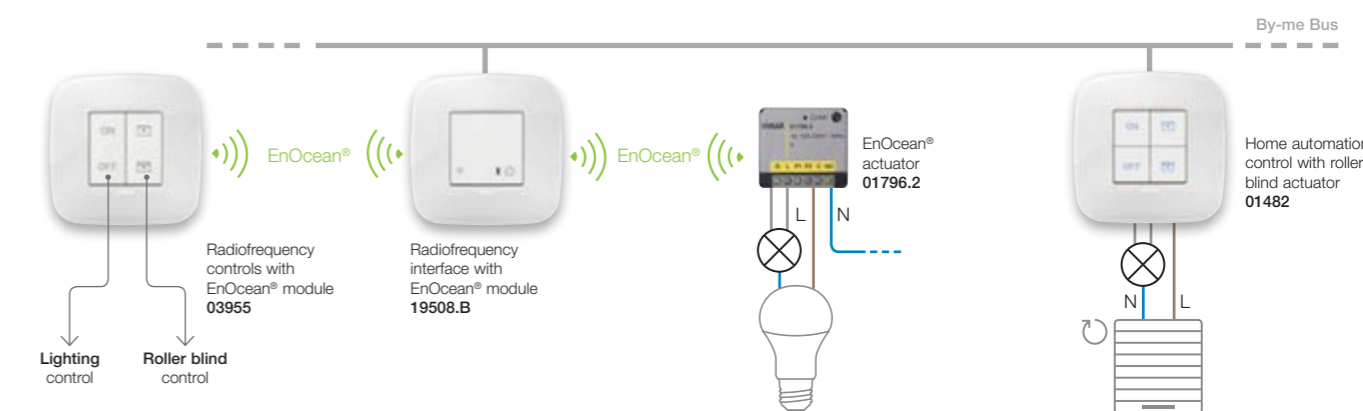

**INTEGRATION WITH PHILIPS HUE.**

By-me Plus natively integrates into with Philips Hue for the **control of the Signify products** matchable with Hue system and controllable from the touch screen, home automation and mobile devices by means the VIEW app.

The home automation controls enable the control the Hue lamps in a timely or aggregate manner, as well as to recall more complex scenarios created with the VIEW app that involve both Hue lamps and other traditional lighting or other functions of the VIEW system (e.g. shutters, music / audio , etc.).

The integration can be performed directly by the end user, without any difficulty using the touch screens or the VIEW app.

The only operation to be made by the installer or in remote control with the VIEW Pro app, is the logical association between the Hue lamps and the wired home automation control.

The **available functions** for Hue lamps control are:

- colour and brightness control (RGBW);
- dynamic white control (change of the light temperature);
- scenarios recall.

In addition, the wireless controls without batteries, based on **Energy Harvesting technological engine** and developed conform to the Friends of Hue program, enable to expand the Hue lighting control functions in total freedom, maintaining the aesthetic coordination and functional integration with the wired home automation system (wireless controls must be configured with the Philips Hue app and can only be used to control the associated lamps).



IP 7" PoE touch screen

Example of integration of By-me Plus system with Philips Hue and with Friends of HUE controls for radiofrequency extension.

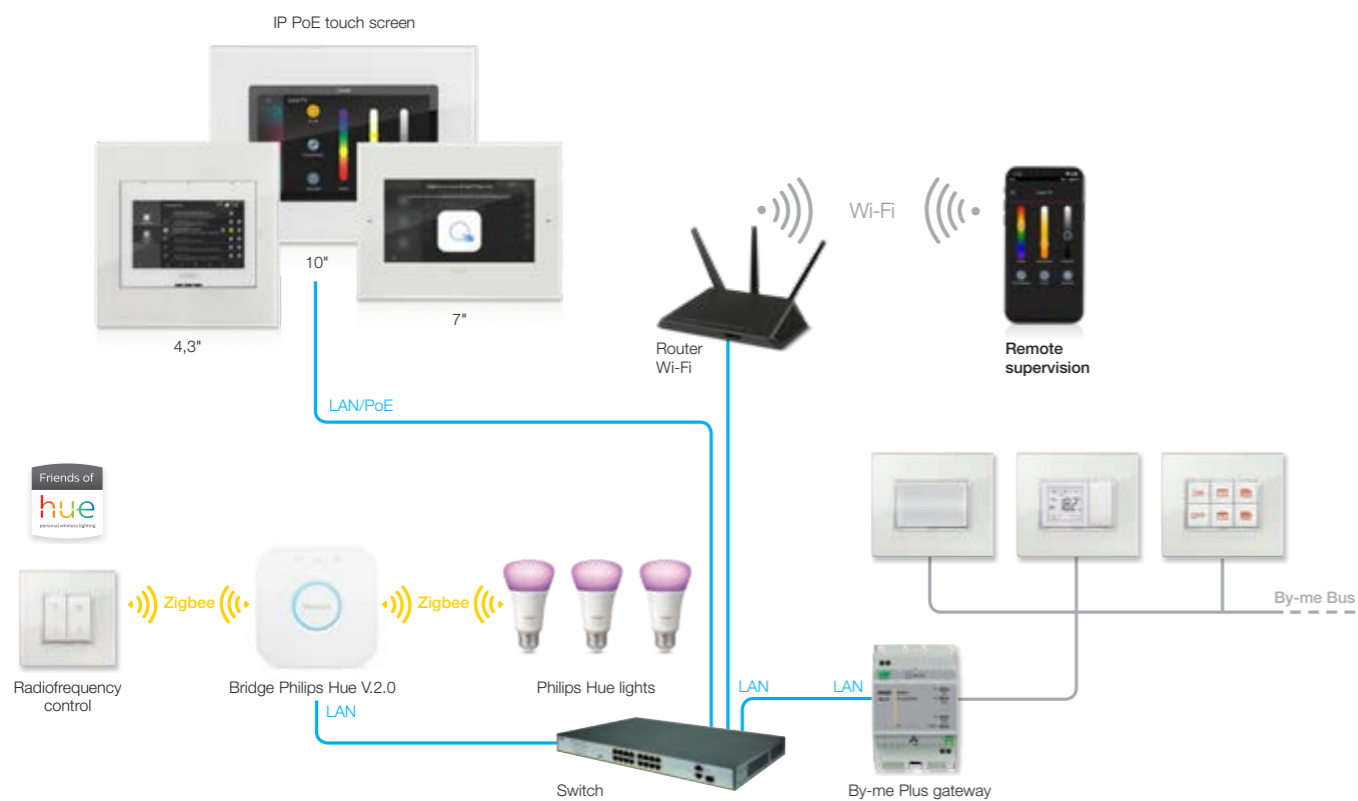

**BY-ME PLUS, OPEN TO DIFFERENT STANDARD.**

The interoperability of the Vimar systems, achieved by the implementation of international standards, always ensures the utmost in terms of synergy and partnership with the main brands operating in similar markets to that of electrical systems. To offer a comprehensive service, based on integration.

**OPEN TO KNX STANDARD.**

By-me Plus is a system is based on the same principles as the KNX, this system is in fact "open", and can therefore be integrated physically (with the same Bus), as well as with KNX systems through **datapoints(DPT)** (protocol defined by the "Interworking" model of the KNX standard), also with third party systems using the wide range of interfaces and gateways available on the market. The datapoints are implemented in the By-me system as *Group Objects* in line with what defined in the KNX architecture.

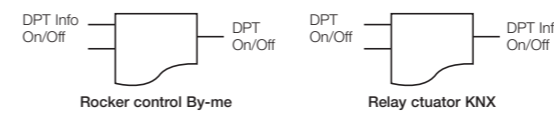

It is possible to use By-me devices to cooperate with devices conforming to the KNX standard, and select them from the list of **datapoints** and **functional units** implemented by the individual devices. To be able to use the *objects* made available by the By-me devices we need to be able to link them to the *objects* of other devices. The link between the *Vimar objects* and other KNX devices is defined via the ETS software, defining the groups on which the KNX devices work to ensure that they are the same as those used by the By-me Plus devices.

**By-me Plus integration with other systems via KNX.**

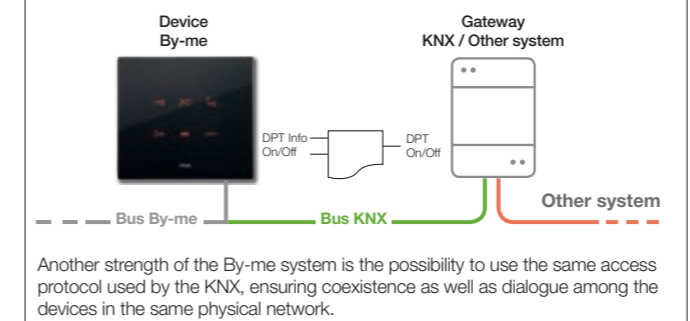

**By-me Plus with KNX standard.**

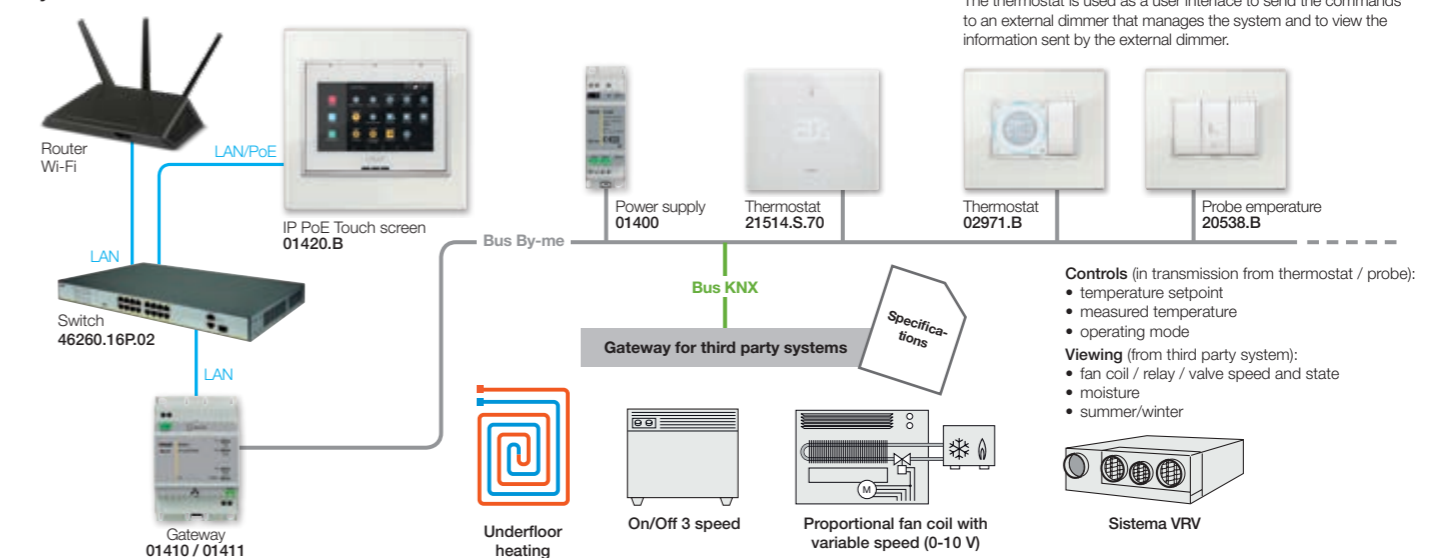

**OPEN TO IP.**

Thanks to the IP-based supervisors and gateway, By-me Plus can be integrated into third-party systems, locally or remotely, by Cloud services availability.

**Locally (LAN network):**

- into By-me Plus supervisors (01420, 01422, 01425) it is possible to open a **webview** (web page) placed on a specific IP address (for ex. third-party webserver);
- through **IP** on the gateway (01410/01411), the By-me Plus system is integrated through a client (for ex. supervisors).

**By-me Plus local integration via IP.**

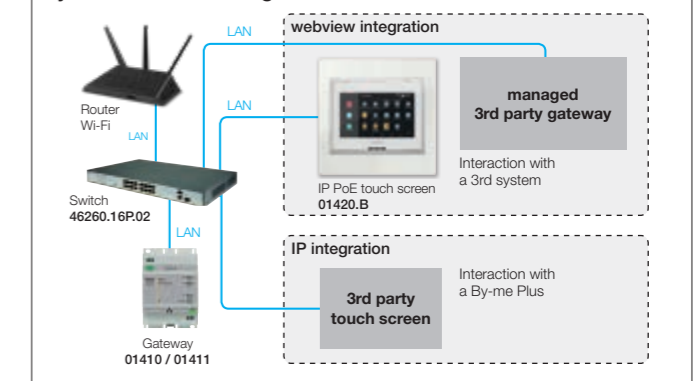

**Remotely (via cloud):**

- it is possible to set functions/interactions on **IFTTT** protocol and manage through the Alexa/Google/Siri smart speakers.

**INTEGRATED SYSTEM REALIZATION.**

The correct operation of the **integrated system** is the responsibility of the installer. Vimar makes available the documents required for integration, clearly indicating which datapoints are usable, from and to the system, and the limits of these integrations. Therefore **Vimar does not guarantee a priori the correct operation of the implemented solution.**

For integration specifications contact the Sales Network.

**Typical system: 160 m<sup>2</sup> house with a system for controlling lights, roller shutters, video door entry system and vocal control.**

The example shows a By-me system specified with **flush mounting actuators** in a house measuring 160 m<sup>2</sup>, which allows:

- control of 11 lights (on-off control) using home automation system switches with built-in actuator 01481 and rocker buttons 01480, and control of 1 light in the living room by means of vocal control 03975;
- control of 9 roller shutters with slat orientation using rocker buttons with built-in actuator 01482 and rocker buttons 01480;
- management of the heating system, in this case consisting of

4 independent zones, via connected dial thermostats 02971, and a thermostat 21514.S.76 in the living room;

- video door entry function with 7" IP touch screen communicating with a Due Fili Plus entrance panel;
- management of the By-me Plus system (for controlling functions and calling up scenarios) from a 7" IP touch screen;
- the home automation system gateway (art. 01410) and flush mounting Wi-Fi access points (art. 19195) allow the automation system to be supervised from a local Wi-Fi network or remotely from a smartphone with the View app.



7" IP touch screen for home automation system supervision



Home automation controls to manage On/OFF scenarios for lights and Up/Down scenarios for roller shutters



Vocal control to manage one light



Home automation controls for controlling lights and roller shutters

Typical system: 160 m<sup>2</sup> house with a system for controlling lights, roller shutters, video door entry system and vocal control.

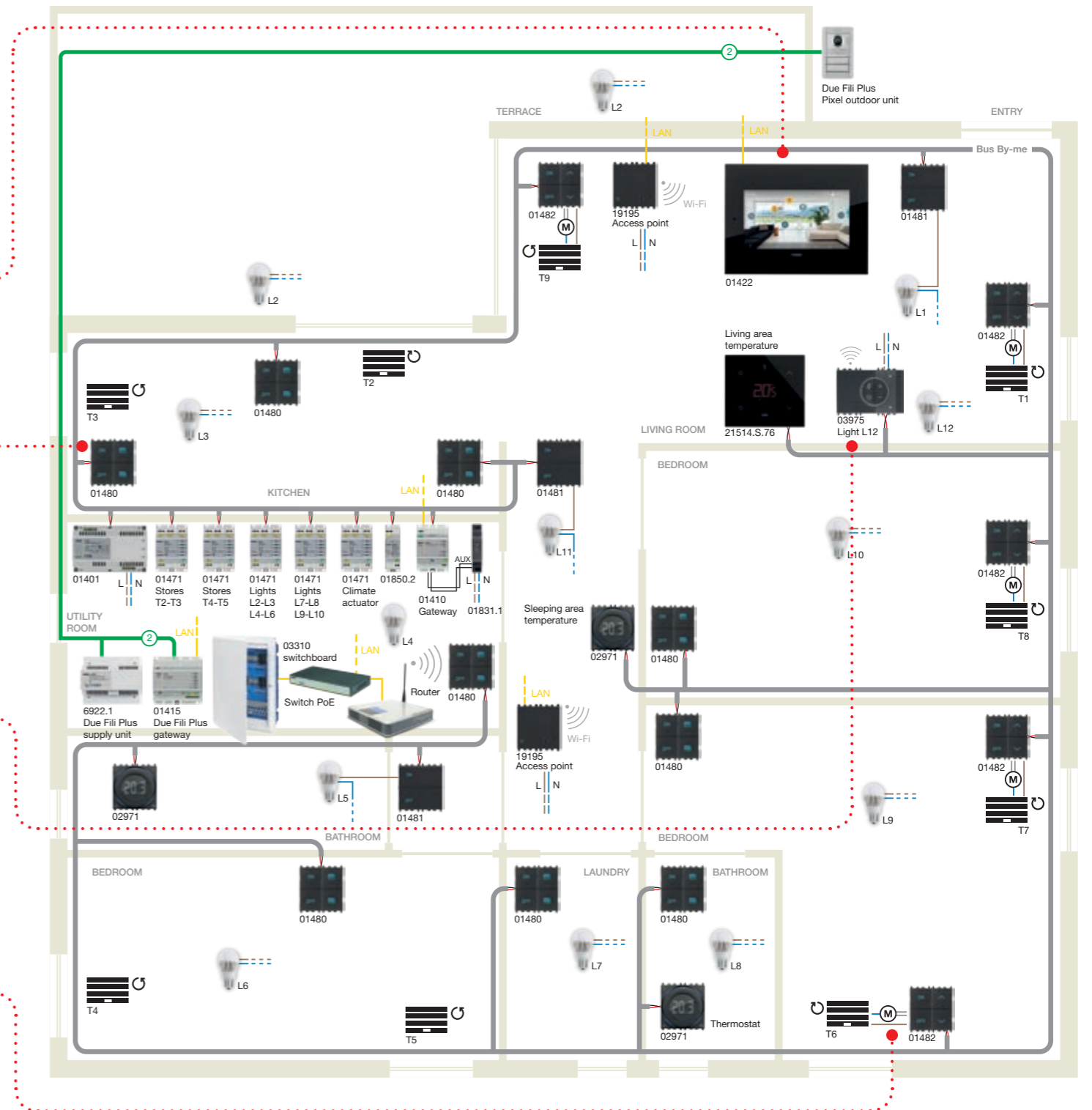

Power supply 230 V- By-me bus LAN connection Due Fili Plus Bus



Typical system: 160 m<sup>2</sup> villa with sound system.

The example shows a sound system in a 160 m<sup>2</sup> villa, with **6 audio inputs** (3 stand alone amplifiers with Bluetooth<sup>®</sup> connected to the four-button home automation controls, a Bluetooth<sup>®</sup> interface, an RCA input and an FM radio tuner) and **6 audio zones** (lounge, kitchen, bathroom and three bedrooms), which allows:

- connection of a CD/DVD player to the RCA 20582 input located in the lounge;
- operation and control of the entire system (audio inputs, volume, change source and change track) from the PoE 4.3" IP touch screen in the living room;
- transmission of playlists on the smartphone to the stand alone

- amplifiers with Bluetooth<sup>®</sup> installed in the three bedrooms;
- management of audio sources and volume from flush mounting controls 01483 and 01484, installed in the kitchen and in the three bedrooms;
- listening to music broadcasts played by FM tuner with RDS 01900, mounted on DIN rail (60715 TH35);
- creation of a Wi-Fi data network, using a router and the flush mounting access points (art. 20195) installed in the lounge and in the hallway, to connect to the Internet from a PC, tablet or smartphone and listen to your favourite music in streaming;
- local or remote supervision of the system via the gateway (art. 01410) and View app.



IP 4.3" PoE Touch screen



Home automation controls and stand-alone amplifier with Bluetooth<sup>®</sup>



Access point



Typical system: 160 m<sup>2</sup> villa with sound system.

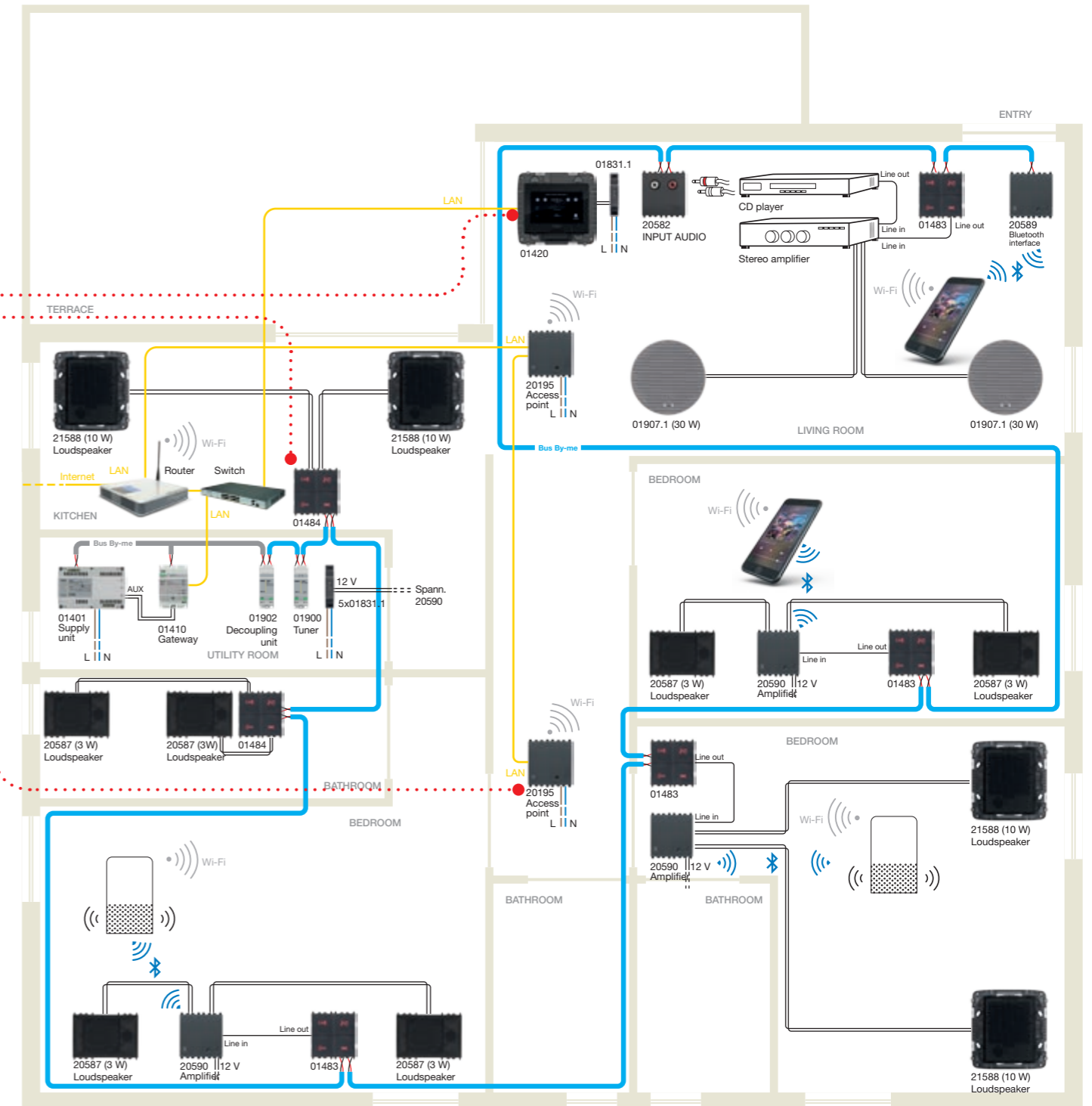

— Bus sound system    — Wired connection    — Power supply 230 V-    — IP connection    - - - 12 V power supply (power supply units 01831.1)

### Typical system: 160 m<sup>2</sup> villa with energy management system (monitoring, photovoltaic production, consumption of single loads and anti blackout system).

The example shows a By-me home automation system integrated with a photovoltaic system, in a 160 m<sup>2</sup> villa, which allows:

- control of **4 single phase loads** (up to 33 kW) using load control module 01455 mounted on DIN rail (60715 TH35) and current sensors 01457;
- display of energy consumed by the 4 single loads on 7" IP colour touch screen 01422 installed in the living room;
- measurement of the energy produced by the photovoltaic system and the energy drawn from the mains using the load control module 01455 mounted on DIN rail (60715 TH35), and a current sensor mounted on a dedicated control unit;

- display of energy produced by the photovoltaic system on 7" IP colour touch screen 01422 installed in the living room;
- water and gas consumption displayed via impulse counters 01452 connected to meters with pulse outputs;
- the supervision of the whole system from a smartphone using the View App and gateway (art. 01410) mounted on DIN rail, and connected to the By-me Bus and a Wi-Fi router.



7" IP colour touch screen with display of energy consumption



Load control module for DIN rail mounting



Actuator with relay output for DIN rail mounting



Typical system: 160 m<sup>2</sup> villa with energy management system (monitoring, photovoltaic production, consumption of single loads and anti blackout system).

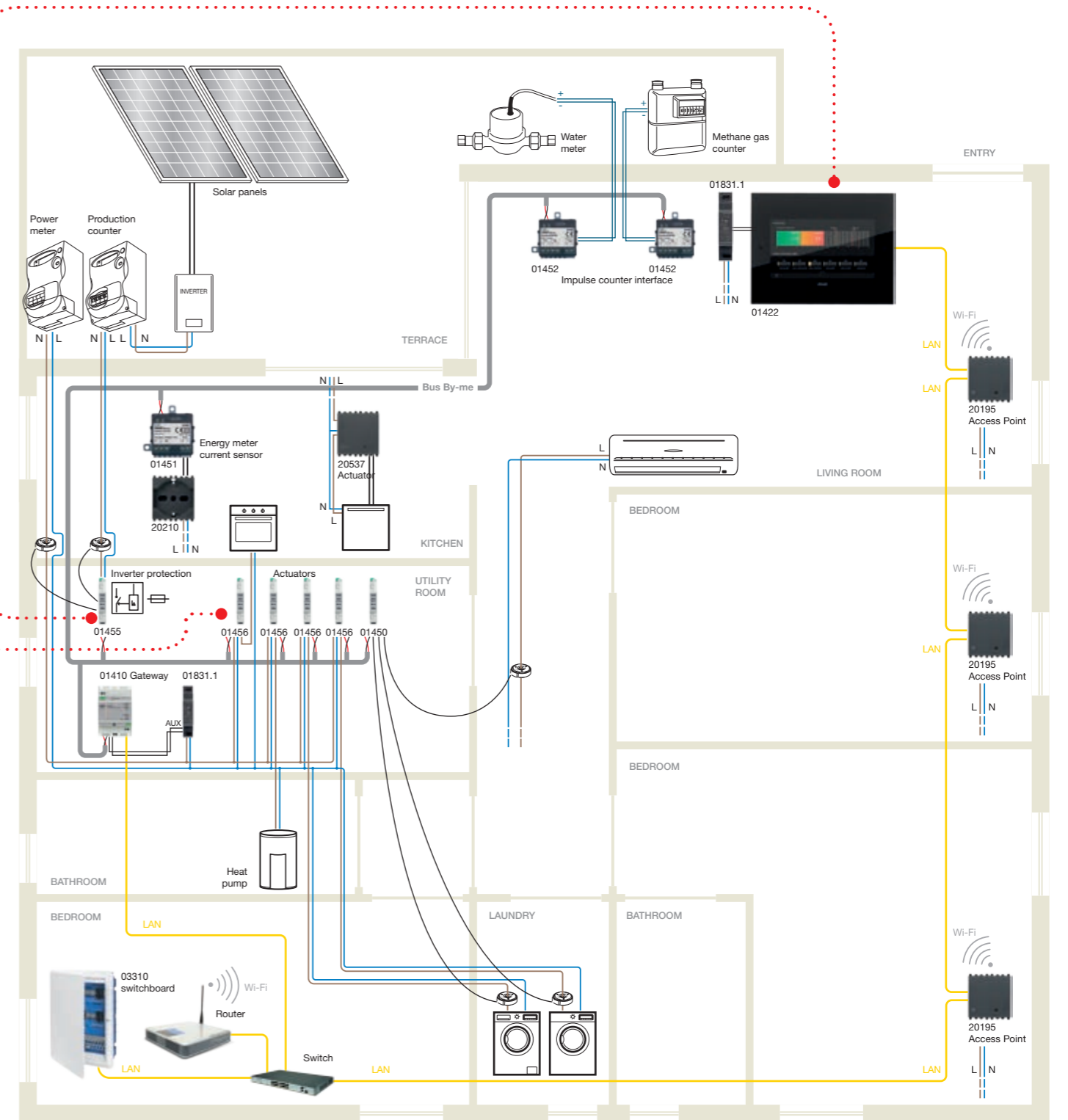

— By-me bus    — Auxiliary power supply    — Wired connection    — Probes connection    — Power supply 230 V-

**Typical system: 160 m<sup>2</sup> house with CCTV, local and remote supervision, and By-alarm burglar alarm system.**

The example shows a typical CCTV system with IP cameras connected to an AHD DVR and to a Wi-Fi router via a switch in a 160 m<sup>2</sup> villa. The 10" IP touch screen, on which the By-camera App is installed, is used to view and control the connected IP cameras.

The images captured by the IP cameras can be transmitted via the router to mobile devices (smartphone or tablet) provided that they have the By-camera App, or to a PC with an Internet browser.

It also has a By-alarm control unit (01703) with an Outputs expansion module (01710) to which the DVR is connected.

With this configuration, when the By-alarm system identifies, for example, an intrusion in zone 2, it sends a signal via the output to which the DVR is connected and this activates recording by the camera installed in zone 2.

The View App can exploit the integration between the CCTV and burglar alarm system to provide local and remote control with alarm notification and video-check streaming.



10" IP touch screen for viewing the images captured by the cameras.



IP cameras



Typical system: 160 m<sup>2</sup> house with CCTV, local and remote supervision, and By-alarm burglar alarm system.

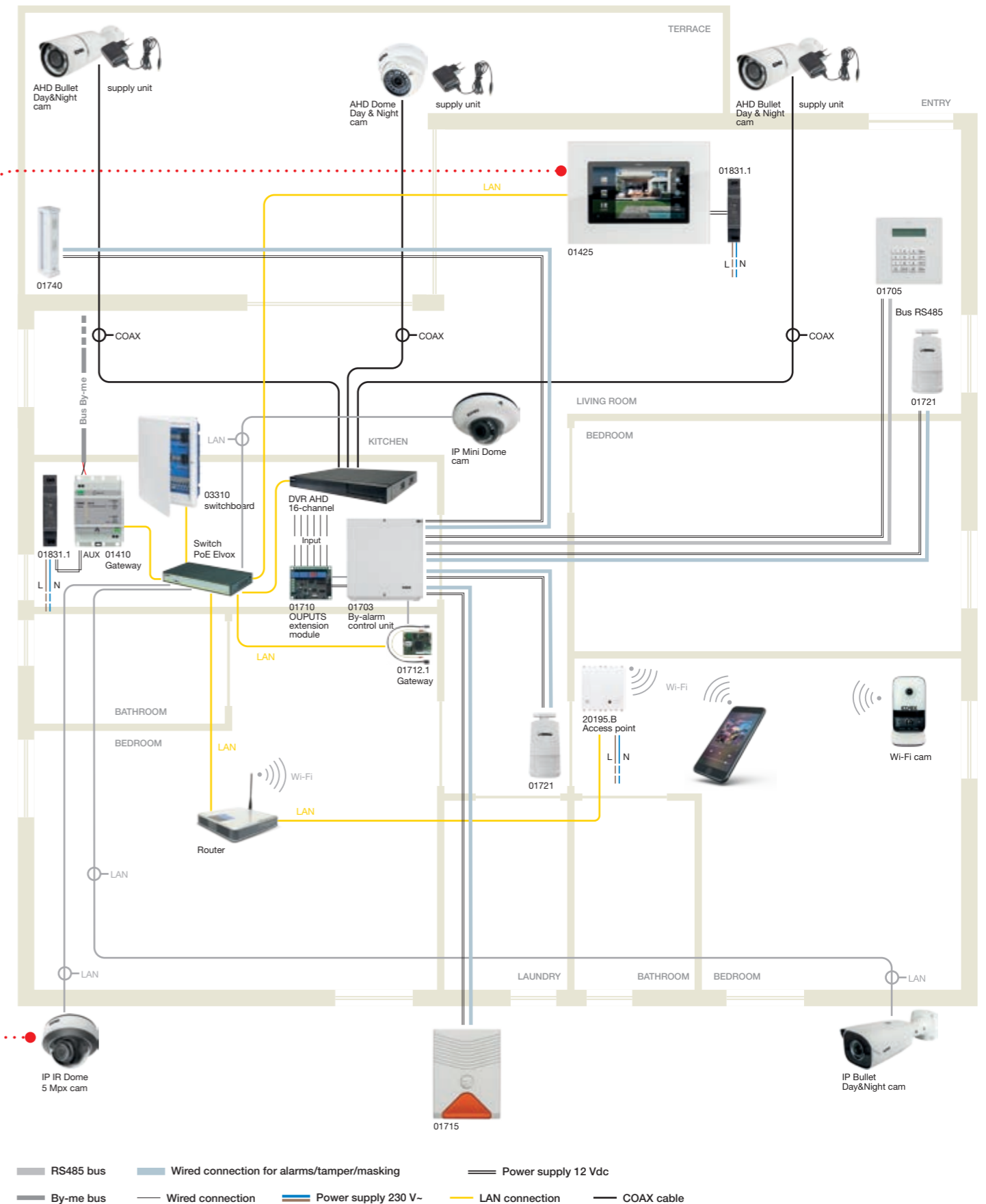

— RS485 bus   
 — Wired connection for alarms/tamper/masking   
 — Power supply 12 Vdc  
— By-me bus   
 — Wired connection   
 — Power supply 230 V-   
 — LAN connection   
 — COAX cable



Typical system: 80 m<sup>2</sup> shop with DALI lights and climate control.

The example shows a By-me system in a shop measuring 80 m<sup>2</sup>, which allows:

- control of the lights via a DALI driver installed in the lamps, and an actuator for DALI/DALI-2 lamps with integrated power supply unit (art. 01419.1) mounted on DIN rail (60715 TH35);
- management of the heating system via a dial thermostat 02971;

- management of the By-me system from a 7" IP touch screen to control functions and call up scenarios (possibility of creating custom scenarios with dimmable RGB lights);
- the home automation system gateway (art. 01410) and flush mounting Wi-Fi access points (art. 14195) allow the automation system to be supervised from a local Wi-Fi network or remotely from a smartphone with the View app.



Home automation controls for light control.

Connected dial thermostat for climate control.

Wi-Fi access point



Typical system: 80 m<sup>2</sup> shop with DALI lights and climate control.

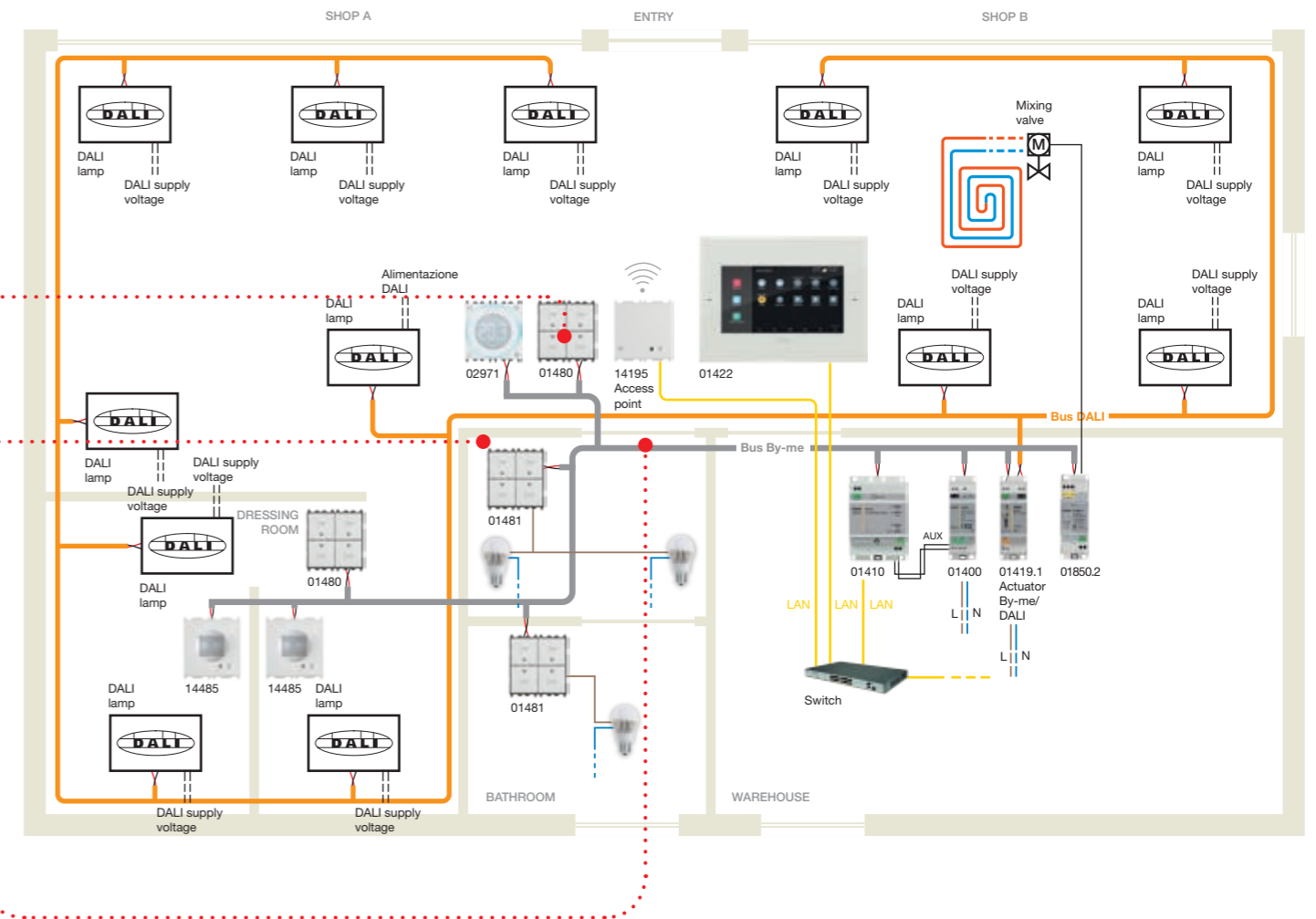

— Power supply 230 V~ — By-me bus — DALI Bus

### Typical system: yacht with system to control lights, blinds and a stand-alone sound system.

The example shows a By-me system implemented with **DIN rail mounted actuators** in a yacht, which allows:

- light control via home automation system controls 01480 and 01485;
- control of the blinds in cabin portholes and living room windows via home automation system controls 01480 and 01485;
- management of the By-me Plus system (for controlling

functions and calling up scenarios) from a 7" IP touch screens in the cabins and living room;

- the home automation system gateway (art. 01411) allows the automation system to be supervised from a local network via a smartphone with the View app.

Moreover, the cabins have a stand-alone sound system, which can transmit the playlist loaded on your smartphone to the Bluetooth® receivers with built-in amplifiers.



### Typical system: yacht with system to control lights, blinds and a stand-alone sound system.

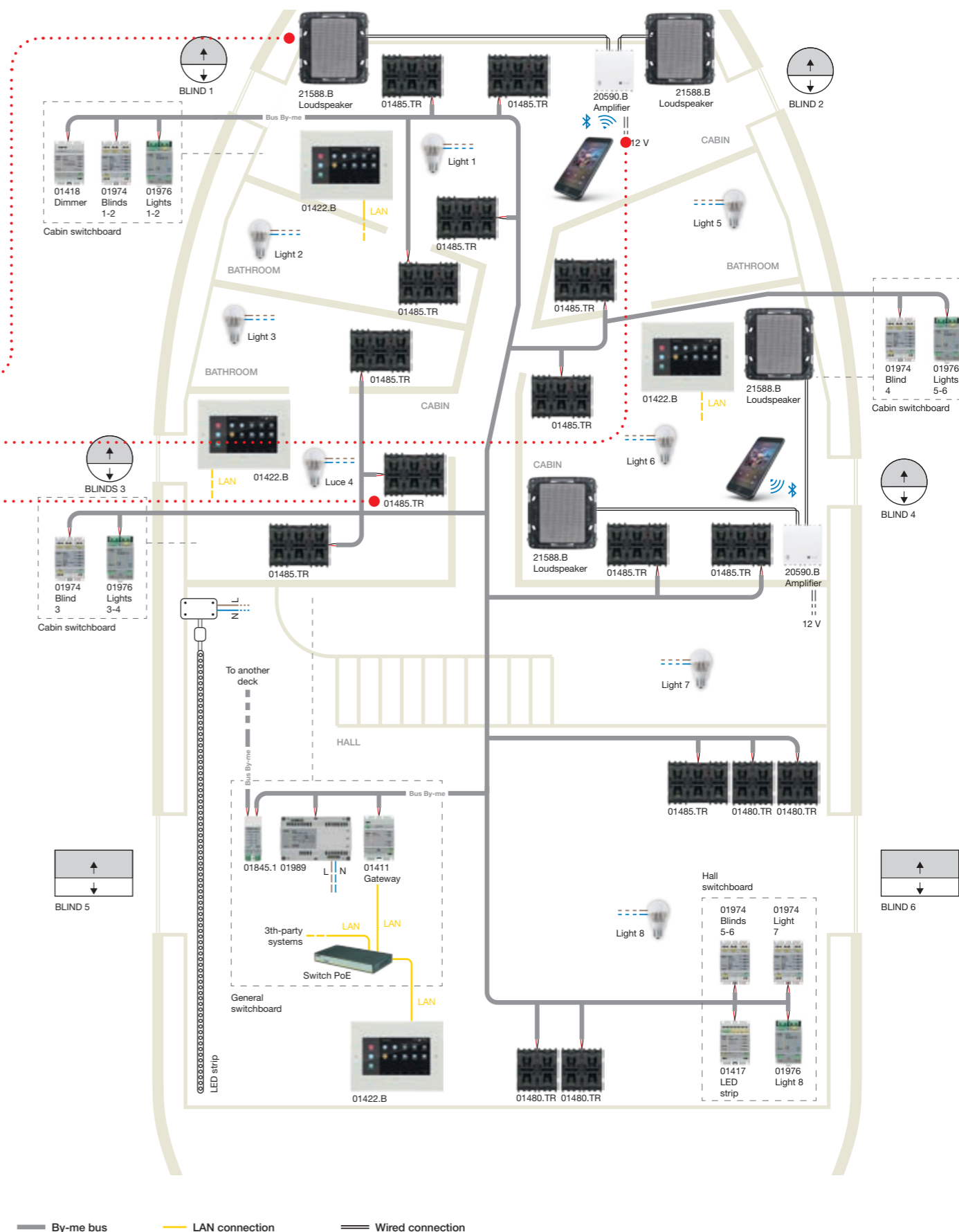

Supervision



**01425**  
10" IP colour touch screen, used as a home automation system supervisor, IP/Due Fili Plus internal video entryphone, IP video camera and CCTV system manager, power supply PoE or 12-30 Vdc, surface mounting with bracket on round, 3-module (horizontal or vertical), 8-module (4+4) or British standard square mounting box, black. To be completed with one of the cover plates shown beside



**21665.11**  
Aluminium cover plate.  
Dimensions: 345x250 mm



**21665.70**  
Crystal cover plate, white diamond.  
Dimensions: 345x250 mm



**21665.76**  
Crystal cover plate, black diamond.  
Dimensions: 345x250 mm



**01422**  
Touch screen with 7" IP capacitive colour display, used as a home automation system supervisor, IP/Due Fili Plus internal video entryphone, IP video camera and CCTV system manager, power supply PoE or 12-30 Vdc, surface mounting with bracket on round, 3-module (horizontal or vertical), 8-module (4+4) or British standard square mounting box, black. Cover plate supplied



**01422.B**  
Touch screen with 7" IP capacitive colour display, used as a home automation system supervisor, IP/Due Fili Plus internal video entryphone, IP video camera and CCTV system manager, power supply PoE or 12-30 Vdc, surface mounting with bracket on round, 3-module (horizontal or vertical), 8-module (4+4) or British standard square mounting box, white. Cover plate supplied



**01420**  
Touch screen with 4,3" IP capacitive colour display, used as a home automation system supervisor, IP/Due Fili Plus internal video entryphone, IP video camera and CCTV system manager, power supply PoE or 12-30 Vdc, with built-in 8 (4+4)-module mounting frame, to be completed with Eikon, Arké or Plana cover plate, black



**01420.B**  
Touch screen with 4,3" IP capacitive colour display, used as a home automation system supervisor, IP/Due Fili Plus internal video entryphone, IP video camera and CCTV system manager, power supply PoE or 12-30 Vdc, with built-in 8 (4+4)-module mounting frame, to be completed with Eikon, Arké or Plana cover plate, white



**01420.BN**  
Touch screen with 4,3" IP capacitive colour display, used as a home automation system supervisor, IP/Due Fili Plus internal video entryphone, IP video camera and CCTV system manager, power supply PoE or 12-30 Vdc, with built-in 8 (4+4)-module mounting frame, to be completed with Eikon, Arké or Plana cover plate, neutral

IP gateway and infrastructure devices



**01410**  
IoT gateway for By-me Plus home automation system, via IP/LAN network, Cloud and app for smartphone, tablet, PC or IP supervision touch screens, **light version** for max 32 devices, 4 x 17,5 mm modules



**01411**  
IoT gateway for By-me Plus home automation system, via IP/LAN network, Cloud and app for smartphone, tablet, PC or IP supervision touch screens, 4 x 17,5 mm modules



**01415**  
IoT gateway for Due Fili Plus video door entry system with IP/LAN network, Cloud and App for smartphone, tablet, PC or supervision touch screens, 6 x 17,5 mm modules

EIKON

ARKÉ

IDEA

PLANA

IP gateway and infrastructure devices



**01416**  
IoT router for IP video door entry system with IP/LAN network, Cloud and App for smartphone, tablet, PC or IP supervision touch screens, 4 x 17,5 mm modules



**01712.1**  
IoT gateway for By-alarm burglar alarm system with IP/LAN, Cloud and App for smartphone, tablet, PC or touch screen supervisor

Wi-Fi access point



**20195**  
Wi-Fi 72,2 Mb/s access point with 2 10-100 Mb/s LAN ports, input for remote Wi-Fi radio on/off push button, supply voltage 230 V-50/60 Hz, grey - 2 modules. Depth: 41 mm



**19195**  
Wi-Fi 72,2 Mb/s access point with 2 10-100 Mb/s LAN ports, input for remote Wi-Fi radio on/off push button, supply voltage 230 V-50/60 Hz, grey - 2 modules. Depth: 40,7 mm



**14195**  
Wi-Fi 72,2 Mb/s access point with 2 10-100 Mb/s LAN ports, input for remote Wi-Fi radio on/off push button, supply voltage 230 V-50/60 Hz, white - 2 modules. Depth: 40 mm



**20195.B**  
Wi-Fi 72,2 Mb/s access point with 2 10-100 Mb/s LAN ports, input for remote Wi-Fi radio on/off push button, supply voltage 230 V-50/60 Hz, white - 2 modules. Depth: 41 mm



**19195.B**  
Wi-Fi 72,2 Mb/s access point with 2 10-100 Mb/s LAN ports, input for remote Wi-Fi radio on/off push button, supply voltage 230 V-50/60 Hz, white - 2 modules. Depth: 40,7 mm



**14195.SL**  
Wi-Fi 72,2 Mb/s access point with 2 10-100 Mb/s LAN ports, input for remote Wi-Fi radio on/off push button, supply voltage 230 V-50/60 Hz, Silver - 2 modules. Depth: 40 mm



**20195.N**  
Wi-Fi 72,2 Mb/s access point with 2 10-100 Mb/s LAN ports, input for remote Wi-Fi radio on/off push button, supply voltage 230 V-50/60 Hz, Metal - 2 modules. Depth: 41 mm



**19195.M**  
Wi-Fi 72,2 Mb/s access point with 2 10-100 Mb/s LAN ports, input for remote Wi-Fi radio on/off push button, supply voltage 230 V-50/60 Hz, Metal - 2 modules. Depth: 40,7 mm

RJ11 jack



**20329**  
RJ11 special jack for Bus connection, screw terminals, grey. Depth: 33,6 mm



**20329.B**  
RJ11 special jack for Bus connection, screw terminals, white. Depth: 33,6 mm



**20329.N**  
RJ11 special jack for Bus connection, screw terminals, Next. Depth: 33,6 mm



**19329**  
RJ11 special jack for Bus connection, screw terminals, grey. Depth: 33,6 mm



**19329.B**  
RJ11 special jack for Bus connection, screw terminals, white. Depth: 33,6 mm



**19329.M**  
RJ11 special jack for Bus connection, screw terminals, Metal. Depth: 33,6 mm



**16339**  
RJ11 special jack for Bus connection, screw terminals, grey. Depth: 33,2 mm



**16339.B**  
RJ11 special jack for Bus connection, screw terminals, white. Depth: 33,2 mm









**14329**  
RJ11 special jack for Bus connection, screw terminals, white. Depth: 32,6 mm



**14329.SL**  
RJ11 special jack for Bus connection, screw terminals, Silver. Depth: 32,6 mm

EIKON ARKÉ PLANA









Infrastructure devices

 <b>01468</b> Logic unit for logic, mathematical, timing and messaging functions, 1 x 17,5 mm modules	 <b>01400</b> Supply unit, 29 Vdc 400 mA output, 230 V~ 50/60 Hz, 2 x 17,5 mm modules	 <b>01401</b> Supply unit, 29 Vdc 1280 mA output, 120-230 V~ 50/60 Hz, 8 x 17,5 mm modules	 <b>01830</b> Supply unit 12 Vdc output, 120-230 V~ 50/60 Hz, 4 x 17,5 mm modules	 <b>01831.1</b> Supply unit 12 Vdc 1250 mA output, 100-240 V~ 50/60 Hz, 1 x 17,5 mm module	 <b>01845.1</b> Line coupler, 2 x 17,5 mm modules
---	--	---	--	---	--

Cables and accessories





 <b>01840.C</b> Bus system cable, 2x0,50 mm <sup>2</sup> , with LSZH sheath, CPR Cca s1b d1 a1 class, suitable for I category cables (U0 = 400 V), yellow - 100 m	 <b>01840.E</b> Bus system cable, 2x0,50 mm <sup>2</sup> , with LSZH sheath, CPR Eca class, suitable for I category cables (U0 = 400 V), white - 100 m	 <b>01841.E</b> Bus system cable, 2x0,50 mm <sup>2</sup> , shielded, with LSZH sheath, CPR Eca class, suitable for I category cables (U0 = 400 V), for marine application, white - 100 m	 <b>01839</b> Removable 2 screw terminals, for Bus system
---	---	---	--

Flush mounting supply units

 <b>20580</b> Supply unit, 32 Vdc 100 mA output, 110-230 V~ 50/60 Hz, grey. Depth: 40 mm	 <b>20580.B</b> Supply unit, 32 Vdc 100 mA output, 110-230 V~ 50/60 Hz, white. Depth: 40 mm	 <b>20580.N</b> Supply unit, 32 Vdc 100 mA output, 110-230 V~ 50/60 Hz, Next. Depth: 40 mm	 <b>19580</b> Supply unit, 32 Vdc 100 mA output, 110-230 V~ 50/60 Hz, grey. Depth: 40 mm	 <b>19580.B</b> Supply unit, 32 Vdc 100 mA output, 110-230 V~ 50/60 Hz, white. Depth: 40 mm	 <b>19580.M</b> Supply unit, 32 Vdc 100 mA output, 110-230 V~ 50/60 Hz, Metal. Depth: 40 mm	 <b>14580</b> Supply unit, 32 Vdc 100 mA output, 110-230 V~ 50/60 Hz, white. Depth: 39 mm	 <b>14580.SL</b> Supply unit, 32 Vdc 100 mA output, 110-230 V~ 50/60 Hz, Silver. Depth: 39 mm
--	--	---	---	--	--	---	--

Control and functions



Voice controls

 <b>▲03975</b> Alexa built-in with built-in Wi-Fi, 2 frontal buttons, RGB LED backlighting, 1 input for wired push button, 1 NO 100-240 V 50/60 Hz relay output for 500 W incandescent lamps, 100 W LED lamps, 250 VA electronic transformers, 120 W fluorescent lamps, local or remote control, for View Wireless mesh system Bluetooth® wireless technology 5.0 or By-me Plus, 100-240 V 50/60 Hz power supply, grey - 3 modules. Depth: 35 mm To be completed with Eikon, Arké and Plana cover plates, for Idea with dedicated mounting frame 16723	 <b>▲03975.B</b> Alexa built-in with built-in Wi-Fi, 2 frontal buttons, RGB LED backlighting, 1 input for wired push button, 1 NO 100-240 V 50/60 Hz relay output for 500 W incandescent lamps, 100 W LED lamps, 250 VA electronic transformers, 120 W fluorescent lamps, local or remote control, for View Wireless mesh system Bluetooth® wireless technology 5.0 or By-me Plus, 100-240 V 50/60 Hz power supply, white - 3 modules. Depth: 35 mm To be completed with Eikon, Arké and Plana cover plates, for Idea with dedicated mounting frame 16723	 <b>▲03975.N</b> Alexa built-in with built-in Wi-Fi, 2 frontal buttons, RGB LED backlighting, 1 input for wired push button, 1 NO 100-240 V 50/60 Hz relay output for 500 W incandescent lamps, 100 W LED lamps, 250 VA electronic transformers, 120 W fluorescent lamps, local or remote control, for View Wireless mesh system Bluetooth® wireless technology 5.0 or By-me Plus, 100-240 V 50/60 Hz power supply, white - 3 modules. Depth: 35 mm To be completed with Eikon, Arké and Plana cover plates, for Idea with dedicated mounting frame 16723	 <b>▲03975.M</b> Alexa built-in with built-in Wi-Fi, 2 frontal buttons, RGB LED backlighting, 1 input for wired push button, 1 NO 100-240 V 50/60 Hz relay output for 500 W incandescent lamps, 100 W LED lamps, 250 VA electronic transformers, 120 W fluorescent lamps, local or remote control, for View Wireless mesh system Bluetooth® wireless technology 5.0 or By-me Plus, 100-240 V 50/60 Hz power supply, Metal - 3 modules. Depth: 35 mm To be completed with Eikon, Arké and Plana cover plates, for Idea with dedicated mounting frame 16723
--	--	--	--



Control and functions

Eikon Tactil controls

 <b>21520.1</b> 4 independent push buttons or 2 rocker buttons, 4 independent RGB LEDs - 2 modules. Depth: 38 mm	 <b>21540.1</b> 6 independent push buttons or 3 rocker buttons, 6 independent RGB LEDs - 3 modules. Depth: 38 mm	 <b>21847</b> 8 stickers sheets with symbols and words for customization of standard function for Eikon Tactil controls	 <b>21847.1</b> 4 sheets with labels featuring symbols and wording for external/internal hotel room or cabin functions for Eikon Tactil controls	 <b>21847.2</b> 4 stickers sheets with symbols and words for customization of standard function for Eikon Tactil controls	 <b>▲ 21847.P</b> Sheet with stickers with symbols and words for customization of function for Eikon Tactil controls
---	---	--	---	--	---

Eikon Exé Flat controls

 <b>01480.AX</b> 4-button, visible in darkness with RGB LED brightness adjustment - 2 modules Depth: 21,5 mm	 <b>01485.AX</b> 6-button, visible in darkness with RGB LED brightness adjustment - 3 modules Depth: 21,5 mm
---	---

Interchangeable half-buttons for Eikon Exé Flat controls - 1 module

 <b>22751.01</b> No symbol, white	 <b>22751.03</b> No symbol, grey	 <b>22751.11</b> No symbol, nickel	 <b>22751.12</b> No symbol, bronze	 <b>22751.82</b> No symbol, gold	 <b>22751.88</b> No symbol, satin gold
 <b>22751.0.01</b> No symbol, customisable <sup>2</sup> , white	 <b>22751.0.03</b> No symbol, customisable <sup>2</sup> , grey	 <b>22751.0.11</b> No symbol, customisable <sup>2</sup> , nickel	 <b>22751.0.12</b> No symbol, customisable <sup>2</sup> , bronze	 <b>22751.0.82</b> No symbol, customisable <sup>2</sup> , gold	 <b>22751.0.88</b> No symbol, customisable <sup>2</sup> , satin gold
 <b>22751.1.01</b> ON/OFF, white	 <b>22751.1.03</b> ON/OFF, grey	 <b>22751.1.11</b> ON/OFF, nickel	 <b>22751.1.12</b> ON/OFF, bronze	 <b>22751.1.82</b> ON/OFF, gold	 <b>22751.1.88</b> ON/OFF, satin gold
 <b>22751.2.01</b> Arrows, white	 <b>22751.2.03</b> Arrows, grey	 <b>22751.2.11</b> Arrows, nickel	 <b>22751.2.12</b> Arrows, bronze	 <b>22751.2.82</b> Arrows, gold	 <b>22751.2.88</b> Arrows, satin gold
 <b>22751.3.01</b> Regulation, white	 <b>22751.3.03</b> Regulation, grey	 <b>22751.3.11</b> Regulation, nickel	 <b>22751.3.12</b> Regulation, bronze	 <b>22751.3.82</b> Regulation, gold	 <b>22751.3.88</b> Regulation, satin gold

EIKON | ARKÉ | PLANA

Control and functions

Eikon, Arké and Plana controls

 <b>01480</b> 4-button - 2 modules <b>01480.TR</b> As above, tropicalized. Depth: 20 mm	 <b>01481</b> 4-button + NO 16 A 120-240 V~ 50/60 Hz relay output - 2 modules. Depth: 37 mm	 <b>01482</b> 4-button + actuator for laths orientation, with relay output for cosφ 0,6 2 A 120-240 V~ 50/60 Hz motor - 2 modules. Depth: 37 mm	 <b>01485</b> 6-button - 3 modules <b>01485.TR</b> As above, tropicalized. Depth: 20 mm	 <b>01486</b> 6-button + NO 16 A 120-240 V~ 50/60 Hz relay output - 3 modules Depth: 37 mm	 <b>01487</b> 6-button + actuator for laths orientation, with relay output for cosφ 0,6 2 A 120-240 V~ 50/60 Hz motor - 3 modules. Depth: 37 mm
 <b>01488</b> 4-button + 240 V~ 50/60 Hz cutting-edge dimmer for 40-200 W incandescent lamps, 40-300 VA at 240 V~ and 20-150 VA at 120 V~ electronic transformers, 10-200 W at 240 V~, 5-100 W at 120 V~ CFL lamps, 3-200 W at 240 V~, 3-100 W at 120 V~ LED lamps, RGB LED location in darkness with brightness control - 2 modules. Depth: 37 mm	 <b>01489</b> 4-button, 1 0/1-10 V SELV output, 1 NO 2 A 120-240 V~ 50/60 Hz relay output for ballast and LED driver, visible in darkness with RGB LED brightness adjustment - 2 modules. Depth: 37 mm				

















Interchangeable half-buttons for controls - 1 module

 <b>20751</b> No symbol, customizable <sup>1</sup> , grey	 <b>20751.B</b> No symbol, customizable <sup>1</sup> , white	 <b>20751.N</b> No symbol, customizable <sup>1</sup> , Next	 <b>19751</b> No symbol, customizable <sup>1</sup> , grey <b>19751.AB</b> As above, anti-bacterial treatment	 <b>19751.B</b> No symbol, customizable <sup>1</sup> , white <b>19751.AB.B</b> As above, anti-bacterial treatment	 <b>19751.M</b> No symbol, customizable <sup>1</sup> , Metal	 <b>14751</b> No symbol, customizable <sup>1</sup> , white	 <b>14751.SL</b> No symbol, customizable <sup>1</sup> , Silver
 <b>20751.0</b> Fixed, grey	 <b>20751.0.B</b> Fixed, white	 <b>20751.0.N</b> Fixed, Next	 <b>19751.0</b> Fixed, grey <b>19751.AB.0</b> As above, anti-bacterial treatment	 <b>19751.0.B</b> Fixed, white <b>19751.AB.0.B</b> As above, anti-bacterial treatment	 <b>19751.0.M</b> Fixed, Metal	 <b>14751.0</b> Fixed, white	 <b>14751.0.SL</b> Fixed, Silver
 <b>20751.1</b> ON/OFF, grey	 <b>20751.1.B</b> ON/OFF, white	 <b>20751.1.N</b> ON/OFF, Next	 <b>19751.1</b> ON/OFF, grey <b>19751.AB.1</b> As above, anti-bacterial treatment	 <b>19751.1.B</b> ON/OFF, white <b>19751.AB.1.B</b> As above, anti-bacterial treatment	 <b>19751.1.M</b> ON/OFF, Metal	 <b>14751.1</b> ON/OFF, white	 <b>14751.1.SL</b> ON/OFF, Silver









EIKON | ARKÉ | PLANA

Control and functions

Interchangeable half-buttons for controls - 1 module

 <b>20751.2</b> Arrows, grey	 <b>20751.2.B</b> Arrows, white	 <b>20751.2.N</b> Arrows, Next	 <b>19751.2</b> Arrows, grey <b>19751.AB.2</b> As above, anti-bacterial treatment	 <b>19751.2.B</b> Arrows, white <b>19751.AB.2.B</b> As above, anti-bacterial treatment	 <b>19751.2.M</b> Arrows, Metal	 <b>14751.2</b> Arrows, white	 <b>14751.2.SL</b> Arrows, Silver
 <b>20751.3</b> Regulation, grey	 <b>20751.3.B</b> Regulation, white	 <b>20751.3.N</b> Regulation, Next	 <b>19751.3</b> Regulation, grey <b>19751.AB.3</b> As above, anti-bacterial treatment	 <b>19751.3.B</b> Regulation, white <b>19751.AB.3.B</b> As above, anti-bacterial treatment	 <b>19751.3.M</b> Regulation, Metal	 <b>14751.3</b> Regulation, white	 <b>14751.3.SL</b> Regulation, Silver

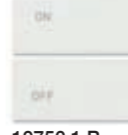
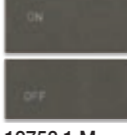
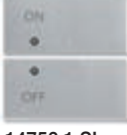















Interchangeable half-buttons for controls - 2 modules

 <b>20752</b> No symbol, customizable <sup>1</sup> , grey	 <b>20752.B</b> No symbol, customizable <sup>1</sup> , white	 <b>20752.N</b> No symbol, customizable <sup>1</sup> , Next	 <b>19752</b> No symbol, customizable <sup>1</sup> , grey	 <b>19752.B</b> No symbol, customizable <sup>1</sup> , white	 <b>19752.M</b> No symbol, customizable <sup>1</sup> , Metal	 <b>14752</b> No symbol, customizable <sup>1</sup> , white	 <b>14752.SL</b> No symbol, customizable <sup>1</sup> , Silver
 <b>20752.1</b> ON/OFF, grey	 <b>20752.1.B</b> ON/OFF, white	 <b>20752.1.N</b> ON/OFF, Next	 <b>19752.1</b> ON/OFF, grey	 <b>19752.1.B</b> ON/OFF, white	 <b>19752.1.M</b> ON/OFF, Metal	 <b>14752.1</b> ON/OFF, white	 <b>14752.1.SL</b> ON/OFF, Silver
 <b>20752.2</b> Arrows, grey	 <b>20752.2.B</b> Arrows, white	 <b>20752.2.N</b> Arrows, Next	 <b>19752.2</b> Arrows, grey	 <b>19752.2.B</b> Arrows, white	 <b>19752.2.M</b> Arrows, Metal	 <b>14752.2</b> Arrows, white	 <b>14752.2.SL</b> Arrows, Silver
 <b>20752.3</b> Regulation, grey	 <b>20752.3.B</b> Regulation, white	 <b>20752.3.N</b> Regulation, Next	 <b>19752.3</b> Regulation, grey	 <b>19752.3.B</b> Regulation, white	 <b>19752.3.M</b> Regulation, Metal	 <b>14752.3</b> Regulation, white	 <b>14752.3.SL</b> Regulation, Silver



Control and functions

Detectors

 <b>20485</b> Passive infrared motion detector, grey. Depth: 26,5 mm	 <b>20485.B</b> Passive infrared motion detector, white. Depth: 26,5 mm	 <b>19485</b> Passive infrared motion detector, grey. Depth: 26,2 mm	 <b>19485.B</b> Passive infrared motion detector, white. Depth: 26,2 mm	 <b>16935</b> Passive infrared motion detector, grey. Depth: 26 mm	 <b>16935.B</b> Passive infrared motion detector, white. Depth: 26 mm	 <b>14485</b> Passive infrared motion detector, white. Depth: 25,5 mm	 <b>14485.SL</b> Passive infrared motion detector, Silver. Depth: 25,5 mm
 <b>20485.N</b> Passive infrared motion detector, Next. Depth: 26,5 mm		 <b>19485.M</b> Passive infrared motion detector, Metal. Depth: 26,2 mm					
 <b>20486</b> Orientable passive infrared motion detector, grey. Depth: 26,5 mm	 <b>20486.B</b> Orientable passive infrared motion detector, white. Depth: 26,5 mm	 <b>19486</b> Orientable passive infrared motion detector, grey. Depth: 26,5 mm	 <b>19486.B</b> Orientable passive infrared motion detector, white. Depth: 26,5 mm				
 <b>20486.N</b> Orientable passive infrared motion detector, Next. Depth: 26,5 mm		 <b>19486.M</b> Orientable passive infrared motion detector, Metal. Depth: 26,5 mm				 <b>01828</b> Mini passive infrared motion detector, for surface mounting, white	

Accessories

 <b>00802.14</b> Orientable support, grey - 2 modules	 <b>00802</b> Orientable support, white - 2 modules	 <b>00802.14</b> Orientable support, grey - 2 modules	 <b>00802</b> Orientable support, white - 2 modules	 <b>00802</b> Orientable support, white - 2 modules	 <b>00802.20</b> Orientable support, Silver - 2 modules
 <b>00802.20</b> Orientable support, Silver - 2 modules					

Control and functions

Accessories

 <b>00805.14</b> Adaptor for orientable support flush mounting, grey - 2 modules. Depth: 36,5 mm	 <b>00805</b> Adaptor for orientable support flush mounting, white - 2 modules. Depth: 36,5 mm	 <b>00805.14</b> Adaptor for orientable support flush mounting, grey - 2 modules. Depth: 36,5 mm	 <b>00805</b> Adaptor for orientable support flush mounting, white - 2 modules. Depth: 36,5 mm	 <b>00805</b> Adaptor for orientable support flush mounting, white - 2 modules. Depth: 36,5 mm	 <b>00805.20</b> Adaptor for orientable support flush mounting, Silver - 2 modules. Depth: 36,5 mm
 <b>00805.20</b> Adaptor for orientable support flush mounting, Silver - 2 modules. Depth: 36,5 mm					
 <b>00800.14</b> Frame for orientable support surface mounting, grey	 <b>00800</b> Frame for orientable support surface mounting, white	 <b>00800.14</b> Frame for orientable support surface mounting, grey	 <b>00800</b> Frame for orientable support surface mounting, white	 <b>00800</b> Frame for orientable support surface mounting, white	 <b>00800.20</b> Frame for orientable support surface mounting, Silver
 <b>00800.20</b> Frame for orientable support surface mounting, Silver					

In/out interfaces

 <b>20518</b> Interface for 2 traditional devices, grey. Depth: 40 mm	 <b>20518.B</b> Interface for 2 traditional devices, white. Depth: 40 mm	 <b>20518.N</b> Interface for 2 traditional devices, Next. Depth: 40 mm	 <b>19518</b> Interface for 2 traditional devices, grey. Ptà: 39,5 mm	 <b>19518.B</b> Interface for 2 traditional devices, white. Ptà: 39,5 mm	 <b>19518.M</b> Interface for 2 traditional devices, Metal. Ptà: 39,5 mm	 <b>16958</b> Interface for 2 traditional devices, grey. Depth: 39,5 mm	 <b>16958.B</b> Interface for 2 traditional devices, white. Depth: 39,5 mm	 <b>14518</b> Interface for 2 traditional devices, white. Depth: 39 mm	 <b>14518.SL</b> Interface for 2 traditional devices, Silver. Depth: 39 mm
 <b>20584.1</b> For By-me commands transmission to IR receiver, with 3 m of cable, grey. Depth: 40 mm	 <b>20584.1.B</b> For By-me commands transmission to IR receiver, with 3 m of cable, white. Depth: 40 mm	 <b>20584.1.N</b> For By-me commands transmission to IR receiver, with 3 m of cable, Next. Depth: 40 mm	 <b>19584.1</b> For By-me commands transmission to IR receiver, with 3 m of cable, grey. Depth: 39 mm	 <b>19584.1.B</b> For By-me commands transmission to IR receiver, with 3 m of cable, white. Depth: 39 mm	 <b>19584.1.M</b> For By-me commands transmission to IR receiver, with 3 m of cable, Metal. Depth: 39 mm	 <b>14584.1</b> For By-me commands transmission to IR receiver, with 3 m of cable, grey. Depth: 39 mm	 <b>14584.1.SL</b> For By-me commands transmission to IR receiver, with 3 m of cable, Silver. Depth: 39 mm		

EIKON ARKÉ IDEA PLANA

Control and functions











Actuators

 <b>20534</b> With 6 A 120-230 V~ change-over relay output, grey, Depth: 40 mm	 <b>20534.B</b> With 6 A 120-230 V~ change-over relay output, white, Depth: 40 mm	 <b>20534.N</b> With 6 A 120-230 V~ change-over relay output, Next, Depth: 40 mm	 <b>19534</b> With 6 A 120-230 V~ change-over relay output, grey, Pt.à: 39,5 mm	 <b>19534.B</b> With 6 A 120-230 V~ change-over relay output, white, Pt.à: 39,5 mm	 <b>19534.M</b> With 6 A 120-230 V~ change-over relay output, Metal, Pt.à: 39,5 mm	 <b>16974</b> With 6 A 120-230 V~ change-over relay output, grey, Depth: 39,5 mm	 <b>16974.B</b> With 6 A 120-230 V~ change-over relay output, white, Depth: 39,5 mm	 <b>14534</b> With 6 A 120-230 V~ change-over relay output, white, Depth: 39 mm	 <b>14534.SL</b> With 6 A 120-230 V~ change-over relay output, Silver, Depth: 39 mm
--	--	---	--	---	---	---	--	--	--



Modules for device backfit

 <b>01475</b> 3 programmable digital inputs module for contacts without potential, 3 LED control outputs, By-me home automation, for flush mounting (backside)	 <b>01476</b> 2 programmable digital inputs module for contacts without potential, 1 relay output for roller blind laths positioning, relay for cosφ 0,6 2 A 120-230 V~ motor, 2 LED control outputs, By-me home automation, for flush mounting (backside)	 <b>01477</b> 2 programmable digital inputs module for contacts without potential, 1 NO 10 A 120-230 V~ 50/60 Hz light control relay output, 2 LED control outputs, By-me home automation, for flush mounting (backside)
--	---	--

Interfaces, actuators and dimmer

 <b>01417</b> Actuator + RGB (W) dimmer, 4 PWM outputs up to 5 A 12-48 Vdc with steady voltage control, brightness adjustment of max 4 monochrome LED or RGB (W) LED strips/spotlights or Dynamic White LED strips/spotlights, 1 NO 6 A 120-240 V~ relay output for LED power units, local control push button, 4 x 17,5 mm modules	 <b>01418</b> Dimmer, 120-240 V~ 50/60 Hz, cutting-edge phase, 2 outputs for 40-300 W at 240 V~, 20-150 W at 120 V~ incandescent lamps, 40-300 VA at 240 V~, 20-150 VA at 120 V~ electronic transformers, CFL 10-200 W at 240 V~, 5-100 W at 120 V~ CFL lamps, 3-200 W at 240 V~, 3-100 W at 120 V~ LED lamps, local control push button, fuse protection, 4 x 17,5 mm modules	 <b>01466.1</b> Actuator with 4 (0)4-20 mA or 0-10 V proportional analogue outputs with max scalable voltage output, 120-230 V~ 50/60 Hz, 4 x 17,5 mm modules. Combined with By-me temperature sensors and thermostats, it allows you to make a modulating room thermostat in class V (3% contribution). Combined with relay actuator, it allows the management of lamps controlled by driver 0/1-10 V	 <b>01419.1</b> Actuator for DALI/DALI-2 lamps with integrated power supply unit, MASTER controller function, max. 64 lamps configurable in 16 By-me Functional Blocks via View Pro app, DALI Device Type 8 for tunable white and RGB(W) management, By-me home automation system, push button for local control, 120-240 V~ 50/60 Hz power supply, 2 x 17,5 mm modules		
 <b>01467</b> Device with 3 analogue signal inputs, 1 0-10 V or 4-20 mA input, 1 NTC sensor input, 1 brightness sensor 01530 input, 2 x 17,5 mm modules	 <b>01850.2</b> Actuator with 16 A 120-230 V~ change-over relay output + push control for manual operating, 2 x 17,5 mm modules	 <b>01470.1</b> Pre-program 9-input and 8-output module, NO 16 A 120-230 V~ 50/60 Hz relay outputs, light control, roller blind laths positioning and local control functions, 6 x 17,5 mm modules	 <b>01471</b> 4 16 A 120-230 V~ change-over relay outputs actuator, programmable for light control, roller blind laths positioning, fan-coil and local control, 4 x 17,5 mm modules	 <b>01975</b> Actuator with 1-10 Vdc 30 mA output for LED control, 120-230 V~ 2,5 A change-over relay output, 120-230 V~ 50/60 Hz, 3 x 17,5 mm modules	 <b>01976</b> Actuator with 1-10 Vdc 30 mA output for LED control, 12-24 V 10 A relay output, 12-24 V~ 50/60 Hz or 12-24 Vdc, 3 x 17,5 mm modules











































Electronic supply units

 <b>01874</b> 230 V~ 50 Hz for LED strip modules 12/24 Vdc, dimmable with MASTER dimmers (not for 230 V~ LED lamps and 0-10 V and 1-10 V ballast) ▲ 01874.120 As above, 120 V~	 <b>01875</b> 230 V~ 50 Hz for LED strip modules 350/500/700 mA, dimmable with MASTER dimmers (not for 230 V~ LED lamps and 0-10 V and 1-10 V ballast) ▲ 01875.120 As above, 120 V~	 <b>01876</b> 230 V~ 50 Hz for RGB LED modules 12/24 Vdc, dimmable with RGB and FADING-SHOW dimmers ▲ 01876.120 As above, 120 V~
--	--	--

\* Not to be used in European Countries    ▲ New article    Δ Available until stocks last







EIKON ARKÉ PLANA



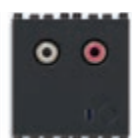

System extension with EnOcean® wireless technology (868 MHz)









 <b>03955</b> 4-button flat device with RF transmission, 868 MHz, EnOcean® standard, energy harvesting supply powered by built-in electrodynamic generator, to complete with buttons - 2 modules. Depth: 3,5 mm	 <b>01796.2</b> Multi-function actuator with relay output NO 10 A 230 V~ programmable with switch function for local control, transferable local input as ON/OFF control for other EnOcean® actuators, 230 V~ 50/60 Hz power supply						
 <b>21507.1</b> Frame for Eikon Evo 2-module cover plates, grey	 <b>21507.1.B</b> Frame for Eikon Evo 2-module cover plates, white	 <b>19507</b> Frame for Arké 2-central-module or 2-module cover plates, grey	 <b>19507.B</b> Frame for Arké 2-central-module or 2-module cover plates, white	 <b>20507</b> Frame for Plana 2-central-module or 2-module cover plates, grey	 <b>20507.B</b> Frame for Plana 2-central-module or 2-module cover plates, white		
 <b>22507</b> Frame for Eikon Exé 2-module cover plates, grey	 <b>22507.B</b> Frame for Eikon Exé 2-module cover plates, white	 <b>19507.CL</b> Frame for Arké Classic 2-module cover plates, grey	 <b>19507.CL.B</b> Frame for Arké Classic 2-module cover plates, white	 <b>14507</b> Frame for Plana 2-module cover plates, white			
 <b>20507</b> Frame for Eikon 2-central-module or 2-module cover plates, grey	 <b>20507.B</b> Frame for Eikon 2-central-module or 2-module cover plates, white	 <b>19507.RN</b> Frame for Arké Round 2-module cover plates, grey	 <b>19507.RN.B</b> Frame for Arké Round 2-module cover plates, white				
 <b>20506</b> Pair of 1-module buttons for RF devices, customisable <sup>1</sup> , grey	 <b>20506.B</b> Pair of 1-module buttons for RF devices, customisable <sup>1</sup> , white	 <b>20506.N</b> Pair of 1-module buttons for RF devices, customisable <sup>1</sup> , Next	 <b>19506</b> Pair of 1-module buttons for RF devices, customisable <sup>1</sup> , grey	 <b>19506.B</b> Pair of 1-module buttons for RF devices, customisable <sup>1</sup> , white	 <b>19506.M</b> Pair of 1-module buttons for RF devices, customisable <sup>1</sup> , Metal	 <b>14506</b> Pair of 1-module buttons for RF devices, customisable <sup>1</sup> , white	 <b>14506.SL</b> Pair of 1-module buttons for RF devices, customisable <sup>1</sup> , Silver
 <b>20506.2</b> 2-module button for RF devices, customisable <sup>1</sup> , grey	 <b>20506.2.B</b> 2-module button for RF devices, customisable <sup>1</sup> , white	 <b>20506.2.N</b> 2-module button for RF devices, customisable <sup>1</sup> , Next	 <b>19506.2</b> 2-module button for RF devices, customisable <sup>1</sup> , grey	 <b>19506.2.B</b> 2-module button for RF devices, customisable <sup>1</sup> , white	 <b>19506.2.M</b> 2-module button for RF devices, customisable <sup>1</sup> , Metal	 <b>14506.2</b> 2-module button for RF devices, customisable <sup>1</sup> , white	 <b>14506.2.SL</b> 2-module button for RF devices, customisable <sup>1</sup> , Silver
 <b>20508</b> EnOcean® Bus interface, grey - 2 modules. Depth: 26,5 mm	 <b>20508.B</b> EnOcean® Bus interface, white - 2 modules. Depth: 26,5 mm	 <b>20508.N</b> EnOcean® Bus interface, Next - 2 modules. Depth: 26,5 mm	 <b>19508</b> EnOcean® Bus interface, grey - 2 modules. Depth: 26,2 mm	 <b>19508.B</b> EnOcean® Bus interface, white - 2 modules. Depth: 26,2 mm	 <b>19508.M</b> EnOcean® Bus interface, Metal - 2 modules. Depth: 26,2 mm	 <b>14508</b> EnOcean® Bus interface, white - 2 modules. Depth: 25,5 mm	 <b>14508.SL</b> EnOcean® Bus interface, Silver - 2 modules. Depth: 25,5 mm









<sup>1</sup> For the customisation of the buttons, see page 160

Sound system

 <b>20582</b> Audio input with 2 RCA connectors, automatic volume adjustment, incorporated line terminator, grey - 2 modules Depth: 37 mm	 <b>20582.B</b> Audio input with 2 RCA connectors, automatic volume adjustment, incorporated line terminator, white - 2 modules Depth: 37 mm	 <b>20582.N</b> Audio input with 2 RCA connectors, automatic volume adjustment, incorporated line terminator, Next - 2 modules Depth: 37 mm	 <b>19582</b> Audio input with 2 RCA connectors, automatic volume adjustment, incorporated line terminator, grey - 2 modules Depth: 36,7 mm	 <b>19582.B</b> Audio input with 2 RCA connectors, automatic volume adjustment, incorporated line terminator, white - 2 modules Depth: 36,7 mm	 <b>19582.M</b> Audio input with 2 RCA connectors, automatic volume adjustment, incorporated line terminator, Metal - 2 modules Depth: 36,7 mm	 <b>14582</b> Audio input with 2 RCA connectors, automatic volume adjustment, incorporated line terminator, white - 2 modules Depth: 36 mm	 <b>14582.SL</b> Audio input with 2 RCA connectors, automatic volume adjustment, incorporated line terminator, Silver - 2 modules Depth: 36 mm
--	--	---	---	--	--	---	--







 <b>20583</b> Spring connector for speaker, grey Depth: 19,4 mm	 <b>20583.B</b> Spring connector for speaker, white Depth: 19,4 mm	 <b>20583.N</b> Spring connector for speaker, Next Depth: 19,4 mm	 <b>19583</b> Spring connector for speaker, grey Depth: 18,9 mm	 <b>19583.B</b> Spring connector for speaker, white Depth: 18,9 mm	 <b>19583.M</b> Spring connector for speaker, Metal Depth: 18,9 mm	 <b>14583</b> Spring connector for speaker, white Depth: 18,4 mm	 <b>14583.SL</b> Spring connector for speaker, Silver Depth: 18,4 mm
--	--	---	---	--	--	---	--

 <b>20589<sup>2</sup></b> Bluetooth <sup>®</sup> interface, storing up to 8 mobile devices, grey - 2 modules Depth: 36 mm	 <b>20589.B<sup>2</sup></b> Bluetooth <sup>®</sup> interface, storing up to 8 mobile devices, white - 2 modules Depth: 36 mm	 <b>20589.N<sup>2</sup></b> Bluetooth <sup>®</sup> interface, storing up to 8 mobile devices, Next - 2 modules Depth: 36 mm	 <b>19589<sup>2</sup></b> Bluetooth <sup>®</sup> interface, storing up to 8 mobile devices, grey - 2 modules Depth: 36,7 mm	 <b>19589.B<sup>2</sup></b> Bluetooth <sup>®</sup> interface, storing up to 8 mobile devices, white - 2 modules Depth: 36,7 mm	 <b>19589.M<sup>2</sup></b> Bluetooth <sup>®</sup> interface, storing up to 8 mobile devices, Metal - 2 modules Depth: 36,7 mm	 <b>14589<sup>2</sup></b> Bluetooth <sup>®</sup> interface, storing up to 8 mobile devices, white - 2 modules Depth: 37 mm	 <b>14589.SL<sup>2</sup></b> Bluetooth <sup>®</sup> interface, storing up to 8 mobile devices, Silver - 2 modules Depth: 37 mm
--	--	---	---	--	--	---	--

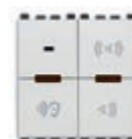
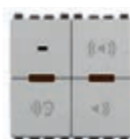



 <b>20590<sup>2</sup></b> 4+4 W RMS stereo amplifier, 2 outputs for 8 Ω sound diffusers with built-in Bluetooth <sup>®</sup> wireless technology receiver, 1 LINE IN, supply voltage 12 Vdc, grey - 2 modules Depth: 36 mm	 <b>20590.B<sup>2</sup></b> 4+4 W RMS stereo amplifier, 2 outputs for 8 Ω sound diffusers with built-in Bluetooth <sup>®</sup> wireless technology receiver, 1 LINE IN, supply voltage 12 Vdc, white - 2 modules Depth: 36 mm	 <b>20590.N<sup>2</sup></b> 4+4 W RMS stereo amplifier, 2 outputs for 8 Ω sound diffusers with built-in Bluetooth <sup>®</sup> wireless technology receiver, 1 LINE IN, supply voltage 12 Vdc, Next - 2 modules Depth: 36 mm	 <b>19590<sup>2</sup></b> 4+4 W RMS stereo amplifier, 2 outputs for 8 Ω sound diffusers with built-in Bluetooth <sup>®</sup> wireless technology receiver, 1 LINE IN, supply voltage 12 Vdc, grey - 2 modules Depth: 36,7 mm	 <b>19590.B<sup>2</sup></b> 4+4 W RMS stereo amplifier, 2 outputs for 8 Ω sound diffusers with built-in Bluetooth <sup>®</sup> wireless technology receiver, 1 LINE IN, supply voltage 12 Vdc, white - 2 modules Depth: 36,7 mm	 <b>19590.M<sup>2</sup></b> 4+4 W RMS stereo amplifier, 2 outputs for 8 Ω sound diffusers with built-in Bluetooth <sup>®</sup> wireless technology receiver, 1 LINE IN, supply voltage 12 Vdc, Metal - 2 modules Depth: 36,7 mm	 <b>14590<sup>2</sup></b> 4+4 W RMS stereo amplifier, 2 outputs for 8 Ω sound diffusers with built-in Bluetooth <sup>®</sup> wireless technology receiver, 1 LINE IN, supply voltage 12 Vdc, white - 2 modules Depth: 36 mm	 <b>14590.SL<sup>2</sup></b> 4+4 W RMS stereo amplifier, 2 outputs for 8 Ω sound diffusers with built-in Bluetooth <sup>®</sup> wireless technology receiver, 1 LINE IN, supply voltage 12 Vdc, Silver - 2 modules Depth: 36 mm
---	---	--	--	---	---	--	---

Sound system













Microphones

 <b>20586</b> Microphone for selective or general call, voice activation function for monitoring children, grey - 2 modules Depth: 37 mm	 <b>20586.B</b> Microphone for selective or general call, voice activation function for monitoring children, white - 2 modules Depth: 37 mm	 <b>20586.N</b> Microphone for selective or general call, voice activation function for monitoring children, Next - 2 modules Depth: 37 mm	 <b>19586</b> Microphone for selective or general call, voice activation function for monitoring children, grey - 2 modules Depth: 37 mm	 <b>19586.B</b> Microphone for selective or general call, voice activation function for monitoring children, white - 2 modules Depth: 37 mm	 <b>19586.M</b> Microphone for selective or general call, voice activation function for monitoring children, Metal - 2 modules Depth: 37 mm	 <b>14586</b> Microphone for selective or general call, voice activation function for monitoring children, white - 2 modules Depth: 36 mm	 <b>14586.SL</b> Microphone for selective or general call, voice activation function for monitoring children, Silver - 2 modules Depth: 36 mm
--	---	--	--	---	---	---	---

Amplifiers and tuners

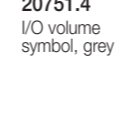
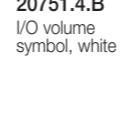
 <b>01483</b> 4-button, 1 LINE OUT output, RGB LED location in darkness with brightness control, to be completed with interchangeable 1- or 2-module half-buttons - 2 modules Depth: 37 mm	 <b>01484</b> 4-button with 1 + 1 W RMS stereo amplifier, 2 x 8 Ω speaker outputs, RGB LED location in darkness with brightness control, to be completed with interchangeable 1- or 2-module half-buttons - 2 modules Depth: 37 mm	 <b>01901</b> Stereo amplifier, 2 outputs for sound diffusers 8 Ω 10+10 W, power supply 110-230 V~ 50/60 Hz, built-in line terminator, 6 x 17,5 mm modules	 <b>01900</b> FM radio tuner with RDS, coaxial connector for external FM antenna, built-in line terminator, 2 x 17,5 mm modules
---	---	--	---

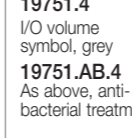
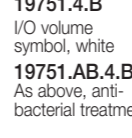
2 interchangeable half-buttons - 1 module

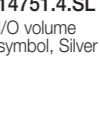
 <b>20751.4</b> I/O volume symbol, grey	 <b>20751.4.B</b> I/O volume symbol, white	 <b>20751.4.N</b> I/O volume symbol, Next	 <b>19751.4</b> I/O volume symbol, grey	 <b>19751.4.B</b> I/O volume symbol, white	 <b>19751.4.M</b> I/O volume symbol, Metal	 <b>14751.4</b> I/O volume symbol, white	 <b>14751.4.SL</b> I/O volume symbol, Silver
 <b>20751.5</b> Function/track change symbol, grey	 <b>20751.5.B</b> Function/track change symbol, white	 <b>20751.5.N</b> Function/track change symbol, Next	 <b>19751.5</b> Function/track change symbol, grey	 <b>19751.5.B</b> Function/track change symbol, white	 <b>19751.5.M</b> Function/track change symbol, Metal	 <b>14751.5</b> Function/track change symbol, white	 <b>14751.5.SL</b> Function/track change symbol, Silver

Sound system

Diffusers



**21588**  
Passive speaker, 8 Ω  
10 W, grey - 8 modules.  
Depth: 48 mm



**20587**  
Passive speaker, 8 Ω 3 W,  
grey - 3 modules.  
Depth: 40 mm



**21588.B**  
Passive speaker, 8 Ω  
10 W, white - 8 modules.  
Depth: 48 mm



**20587.B**  
Passive speaker, 8 Ω 3 W,  
white - 3 modules.  
Depth: 40 mm



**21588.N**  
Passive speaker, 8 Ω  
10 W, Next - 8 modules.  
Depth: 48 mm



**20587.N**  
Passive speaker, 8 Ω 3 W,  
Next - 3 modules.  
Depth: 40 mm



**01906**  
IP55 passive speaker, 8 Ω 30 W,  
for hollow walls and false ceiling  
installation. Depth: 70 mm



**01907.1**  
Passive speaker, 8 Ω 30 W,  
for hollow walls and false  
ceiling installation. Depth: 68 mm



**01908**  
Passive speaker, 8 Ω 30 W, orientable,  
for surface mounting

System components



**01903**  
Branch shunt for By-me  
devices, flush mounting  
(retrofit)



**01904**  
Branch shunt for  
sound system devices,  
flush mounting (retrofit)



**01902**  
Bus line/sound system  
decoupler for By-me  
power supply, built-in  
line terminator,  
2 x 17,5 mm modules



**01831.1**  
Supply unit 12 Vdc  
1250 mA output,  
100-240 V~ 50/60 Hz,  
1 x 17,5 mm  
modules



**01840.E.B**  
By-me system Bus cable for sound  
system, 2x0,50 mm<sup>2</sup>, with LSZH  
sheath, CPR Eca class, suitable  
for I category cables (U0 = 400 V),  
blue - 100 m



**01839**  
Removable  
2 screw  
terminals, for  
Bus system

Temperature control

Thermostats



**02951**  
Touch screen thermostat for ON/OFF, PWM  
and PID temperature control, for 2- and 4-pipe  
systems, 3-speed/proportional fan coil control,  
1 input for NTC sensor, black - 2 modules.  
Depth: 38,5 mm



**02951.B**  
Touch screen thermostat for ON/OFF, PWM  
and PID temperature control, for 2- and 4-pipe  
systems, 3-speed/proportional fan coil control,  
1 input for NTC sensor, white - 2 modules.  
Depth: 38,5 mm



**02951.BN**  
Touch screen thermostat for ON/OFF, PWM  
and PID temperature control, for 2- and 4-pipe  
systems, 3-speed/proportional fan coil control,  
1 input for NTC sensor, neutral - 2 modules.  
Depth: 38,5 mm



**02971**  
Dial thermostat (heating and air conditioning), 2- and 4-pipe system  
management, 3-speed and proportional fan coil control, class I  
(contribution 1%) in ON/OFF mode, class IV (contribution 2%) in  
PID mode, can be interfaced with actuator 01466.1 to make a  
class V modulating room thermostat (contribution 3%), 1 input for  
sensor 20432, 19432, 14432 or 02965.1, white LED backlighting,  
grey - 2 modules. Depth: 28,5 mm



**02971.B**  
Dial thermostat (heating and air conditioning), 2- and 4-pipe system  
management, 3-speed and proportional fan coil control, class I  
(contribution 1%) in ON/OFF mode, class IV (contribution 2%) in  
PID mode, can be interfaced with actuator 01466.1 to make a  
class V modulating room thermostat (contribution 3%), 1 input for  
sensor 20432, 19432, 14432 or 02965.1, white LED backlighting,  
white - 2 modules. Depth: 28,5 mm

Eikon Tactil thermostats



**21514.F.70**  
Touch screen thermostat (heating and air conditioning), 3-speed and  
proportional FAN COIL control, class I (contribution 1%) in ON/OFF  
mode, class IV (contribution 2%) in PID mode, can be interfaced with  
actuator 01466.1 to make a class V modulating room thermostat  
(contribution 3%), 1 input for sensor 20432, 19432 or 14432 or wired  
sensor 02965.1, 1 programmable digital input, RGB LED backlighting,  
white diamond - 2 modules. Depth: 30,2 mm



**21514.F.76**  
Touch screen thermostat (heating and air conditioning), 3-speed and  
proportional FAN COIL control, class I (contribution 1%) in ON/OFF  
mode, class IV (contribution 2%) in PID mode, can be interfaced with  
actuator 01466.1 to make a class V modulating room thermostat  
(contribution 3%), 1 input for sensor 20432, 19432 or 14432 or wired  
sensor 02965.1, 1 programmable digital input, RGB LED backlighting,  
black diamond - 2 modules. Depth: 30,2 mm



**21514.S.70**  
Touch screen thermostat (heating and air conditioning), configurable  
STAR control, class I (contribution 1%) in ON/OFF mode, class IV  
(contribution 2%) in PID mode, can be interfaced with actuator 01466.1  
to make a class V modulating room thermostat (contribution 3%), 1 input  
for sensor 20432, 19432 or 14432 or wired sensor 02965.1, 1 pro-  
grammable digital input, RGB LED backlighting,  
white diamond - 2 modules. Depth: 30,2 mm



**21514.S.76**  
Touch screen thermostat (heating and air conditioning), configurable  
STAR control, class I (contribution 1%) in ON/OFF mode, class  
IV (contribution 2%) in PID mode, can be interfaced with actuator  
01466.1 to make a class V modulating room thermostat (contribution  
3%), 1 input for sensor 20432, 19432 or 14432 or wired sensor  
02965.1, 1 programmable digital input, RGB LED backlighting,  
black diamond - 2 modules. Depth: 30,2 mm

Temperature control

Eikon Tactil thermostats



21514.H.70

Touch screen thermostat (heating and air conditioning), MAKE UP ROOM and DO NOT DISTURB control, class I (contribution 1%) in ON/OFF mode, class IV (contribution 2%) in PID mode, can be interfaced with actuator 01466.1 to make a class V modulating room thermostat (contribution 3%), 1 input for sensor 20432, 19432 or 14432 or wired sensor 02965.1, 1 programmable digital input, RGB LED backlighting, white diamond - 2 modules. Depth: 30,2 mm



21514.H.76

Touch screen thermostat (heating and air conditioning), MAKE UP ROOM and DO NOT DISTURB control, class I (contribution 1%) in ON/OFF mode, class IV (contribution 2%) in PID mode, can be interfaced with actuator 01466.1 to make a class V modulating room thermostat (contribution 3%), 1 input for sensor 20432, 19432 or 14432 or wired sensor 02965.1, 1 programmable digital input, RGB LED backlighting, black diamond - 2 modules. Depth: 30,2 mm

Probes and sensors

 <b>20538</b> Temperature probe for ON/OFF, PWM, PID and dew point control, for 2- and 4-pipe systems, 3-speed/proportional fan coil control, 1 input for NTC sensor, grey. Depth: 40 mm	 <b>20538.B</b> Temperature probe for ON/OFF, PWM, PID and dew point control, for 2- and 4-pipe systems, 3-speed/proportional fan coil control, 1 input for NTC sensor, white. Depth: 40 mm	 <b>20538.N</b> Temperature probe for ON/OFF, PWM, PID and dew point control, for 2- and 4-pipe systems, 3-speed/proportional fan coil control, 1 input for NTC sensor, Next. Depth: 40 mm	 <b>19538</b> Temperature probe for ON/OFF, PWM, PID and dew point control, for 2- and 4-pipe systems, 3-speed/proportional fan coil control, 1 input for NTC sensor, grey. Depth: 40 mm	 <b>19538.B</b> Temperature probe for ON/OFF, PWM, PID and dew point control, for 2- and 4-pipe systems, 3-speed/proportional fan coil control, 1 input for NTC sensor, white. Depth: 40 mm	 <b>19538.M</b> Temperature probe for ON/OFF, PWM, PID and dew point control, for 2- and 4-pipe systems, 3-speed/proportional fan coil control, 1 input for NTC sensor, Metal. Depth: 40 mm	 <b>14538</b> Temperature probe for ON/OFF, PWM, PID and dew point control, for 2- and 4-pipe systems, 3-speed/proportional fan coil control, 1 input for NTC sensor, white. Depth: 39 mm	 <b>14538.SL</b> Temperature probe for ON/OFF, PWM, PID and dew point control, for 2- and 4-pipe systems, 3-speed/proportional fan coil control, 1 input for NTC sensor, Silver. Depth: 39 mm
 <b>20432</b> Electronic temperature sensor, 1 output, grey. Depth: 24,4 mm	 <b>20432.B</b> Electronic temperature sensor, 1 output, white. Depth: 24,4 mm	 <b>20432.N</b> Electronic temperature sensor, 1 output, Next. Depth: 24,4 mm	 <b>19432</b> Electronic temperature sensor, 1 output, grey. Depth: 24,4 mm	 <b>19432.B</b> Electronic temperature sensor, 1 output, white. Depth: 24,4 mm	 <b>19432.M</b> Electronic temperature sensor, 1 output, Metal. Depth: 24,4 mm	 <b>14432</b> Electronic temperature sensor, 1 output, white. Depth: 23,4 mm	 <b>14432.SL</b> Electronic temperature sensor, 1 output, Silver. Depth: 23,4 mm
 <b>20433</b> Humidity sensor, 1 0-10 V or 4-20 mA output, 12/24V, grey - 2 modules. Depth: 37 mm	 <b>20433.B</b> Humidity sensor, 1 0-10 V or 4-20 mA output, 12/24V, white - 2 modules. Depth: 37 mm	 <b>20433.N</b> Humidity sensor, 1 0-10 V or 4-20 mA output, 12/24V, Next - 2 modules. Depth: 37 mm	 <b>19433</b> Humidity sensor, 1 0-10 V or 4-20 mA output, 12/24V, grey - 2 modules. Depth: 37 mm	 <b>19433.B</b> Humidity sensor, 1 0-10 V or 4-20 mA output, 12/24V, white - 2 modules. Depth: 37 mm	 <b>19433.M</b> Humidity sensor, 1 0-10 V or 4-20 mA output, 12/24V, Metal - 2 modules. Depth: 37 mm	 <b>14433</b> Humidity sensor, 1 0-10 V or 4-20 mA output, 12/24V, white - 2 modules. Depth: 36 mm	 <b>14433.SL</b> Humidity sensor, 1 0-10 V or 4-20 mA output, 12/24V, Silver - 2 modules. Depth: 36 mm



02965.1

Wired temperature sensor, NTC 10 kΩ, cable length 3 m











01465





Climate control device for heating systems, power supply 120-230 V~ 50/60 Hz, 3 inputs for PT100, PT1000 and NTC probes, 1 mixer valve control output, 1 0-10 V or (I) 4-20 mA output, 1 16 A 230 V~ change-over relay output, 6 x 17,5 mm modules

Energy management

Actuators

 <b>20537</b> Actuator with relay output 16 A 120-230 V~ 50/60 Hz with incorporated current sensor, grey - 2 modules. Depth: 37 mm	 <b>20537.B</b> Actuator with relay output 16 A 120-230 V~ 50/60 Hz with incorporated current sensor, white - 2 modules. Depth: 37 mm	 <b>20537.N</b> Actuator with relay output 16 A 120-230 V~ 50/60 Hz with incorporated current sensor, Next - 2 modules. Depth: 37 mm	 <b>19537</b> Actuator with relay output 16 A 120-230 V~ 50/60 Hz with incorporated current sensor, grey - 2 modules. Depth: 36,7 mm	 <b>19537.B</b> Actuator with relay output 16 A 120-230 V~ 50/60 Hz with incorporated current sensor, white - 2 modules. Depth: 36,7 mm	 <b>19537.M</b> Actuator with relay output 16 A 120-230 V~ 50/60 Hz with incorporated current sensor, Metal - 2 modules. Depth: 36,7 mm	 <b>14537</b> Actuator with relay output 16 A 120-230 V~ 50/60 Hz with incorporated current sensor, white - 2 modules. Depth: 36 mm	 <b>14537.SL</b> Actuator with relay output 16 A 120-230 V~ 50/60 Hz with incorporated current sensor, Silver - 2 modules. Depth: 36 mm
---	--	---	---	--	--	--	--

Meters

 <b>01451</b> Energy meter with incorporated current sensor, measurable powers up to 3680 W, flush mounting (retrofit)	 <b>01452</b> Pulse counter interface for measuring data from devices fitted with pulse outputs, such as electricity, water and gas meters, flush mounting (retrofit)	 <b>01450</b> Energy meter, 3 x inputs toroidal sensor, 25 W-100 kW, 120-230 V 50/60 Hz, 230/400 V 50/60 Hz, 1 x 17,5 mm modules. Supplied with toroidal current sensor 01457	 <b>01455</b> Load control module, 3 x inputs toroidal sensor, 25 W-100 kW, 120-230 V 50/60 Hz, 230/400 V 50/60 Hz, 1 x 17,5 mm modules. Supplied with toroidal current sensor 01457	 <b>01456</b> Actuator, 16 A 120-230 V~ 50/60 Hz relay output for toroidal differential current sensor, 1 x 17,5 mm modules. Supplied without toroidal differential current sensor
--	---	---	--	--



01457

Toroidal current sensor for load control and power measurement, hole diameter 7,5 mm, cable length 40 cm



01458

Toroidal current sensor for load control and power measurement, hole diameter 19 mm, cable length 40 cm



01459

Toroidal differential current sensor for power measurement, hole diameter 9 mm, cable length 40 cm



01546

Weather station, KNX standard, power supply 12-32 Vdc or 12-24 Vac

Index

---

General introduction

Smart products

View Wireless

By-me Plus

**Well-contact Plus**

Call-way and antibacterial solutions

## Well-contact Plus



Introduction	138
System architecture	144
Typical systems	154
Supervision	166
Control and functions	168
Temperature control	172
Access control	176



## Well-contact Plus:

building automation for the whole building, with integrated functions and centralised monitoring.

Flexible, interoperable and modular, **Well-contact Plus** is the Vimar system developed on the **KNX standard**, for complete building management. Whether in small or large hotels, offices, multi-purpose centres or even gyms, Well-contact Plus is the solution that provides constant control and management of lights, temperature, security, energy and accesses, with functions and comfort in every single environment, and it can also be integrated with third-party systems.



**Residential**



**Schools  
and offices**



**Hotels**



## Maximum performance in the residential sector.

With Well-contact Plus **control, comfort and energy efficiency** are guaranteed. Indeed, the system permits the centralised management of any building. Raising and lowering curtains or roller shutters, setting the climate, dimming lighting, controlling access points, all managed from a single point.

### CONTROLS FOR AUTOMATIONS.

KNX controls for automatic devices that raise/lower roller shutters. They are fitted with RGB LEDs with set symbols, chosen from a wide library. Available for the Eikon, Arké and Plana series, also with on-board actuator.



### SMART LIGHTING.

KNX devices for switching on/off the lighting, adjusting the brightness and manage the DALI lamps by means the gateway.

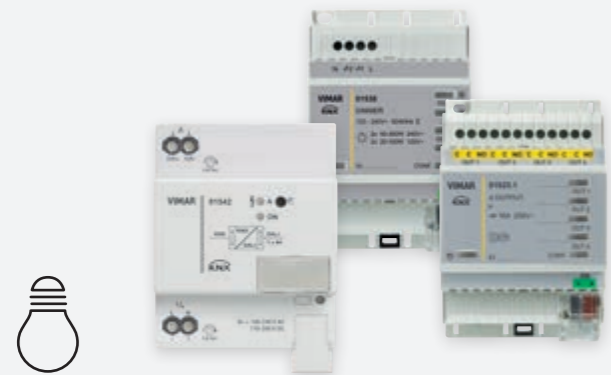

### ENERGY MANAGEMENT.

Movement and brightness sensors to switch on/off the lighting, adjust the temperature when necessary providing the perfect blend of functionality and energy efficiency.

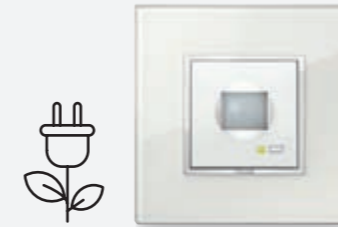

### THERMOREGULATION.

Thermostats for heating/air-conditioning adjustment and for assuring a perfect comfort in your home. If you install a magnetic contact on the windows, the system detects when it is open and switch off immediately the heating/air-conditioning providing an effective energy saving.



### SUPERVISION.

By means the touch screens and web server it is possible to control your home, locally or remotely, for automation functions and for special system.





## Advanced solutions in tertiary sector for offices, schools and hotel.

High-performing, safe and immediate. For the **control, comfort, energy efficiency** and **safety** of offices and the service industry, Well-contact Plus offers a series of devices and systems to ensure the quick, effective and centralised management of all workplaces. All the systems present are fully integrated and this results in real benefits, **preventing futile waste** and increasing well-being. The **climate** is controlled using a centralised system which can be activated or deactivated depending on whether people are present and on whether or not a window is open. The **security** of the system is ensured by transponder card readers which only allow specific areas or environments to be accessed by authorised persons and enable the reception to control the room status.

### CENTRALIZED SUPERVISION.

Elegant touch devices enable the centralised control of every rooms of the building and the applications of Well-contact Suite software allow to decide specific functions and manage alla devices of the system.



### OPTIMUM CLIMATE CONTROL.

Dial thermostat controls room temperature to assure made-to-measure comfort. The status can be managed and supervised from the reception.



### ACCESS CONTROL.

Simply place the card near the reader to open the electrical lock and turn on the courtesy lights. The reader is used to restrict the access to different environments to authorised persons and controls the status of the rooms.



### COMFORT.

To respond to specific moments in the working day, customised scenarios can be called up from a single point, by activating several functions at the same time. Thus, for a multimedia presentation, one gesture is all that is needed to lower the screen and draw the curtains, dim the lights and activate the projector.



### ENERGY SAVING.

By means the movement and brightness detectors, lighting and temperature are always controlled, switching on/off when necessary and preventing wastes. Scenarios can be created in order to collect more functions in one action, managing all the building with a few gestures.



## System architecture.

The Well-contact Plus system, in the **hotel, service and residential sectors**, is used to create **centralised management** systems that permit the efficient integration and supervision of many functions and services, guaranteeing that it is easy to use by the personnel in charge.

In fact, more and more often, **for the optimized and effective management of their services** hotels and, more in general, hospitality facilities are requiring systems that simplify their daily operations and reduce, as far as possible, running costs, optimizing energy saving and guaranteeing a high level of comfort for their guests.

The devices of the Well-contact Plus system, developed to **KNX standard technology** and aesthetically coordinated with the Eikon, Arké, Idea and Plana series, offer technical solutions featuring outstanding efficiency, perfectly meeting all the most varied installation requirements and managing the constraints imposed by the different structures such as hotels, offices, shopping centres and advanced service industries.

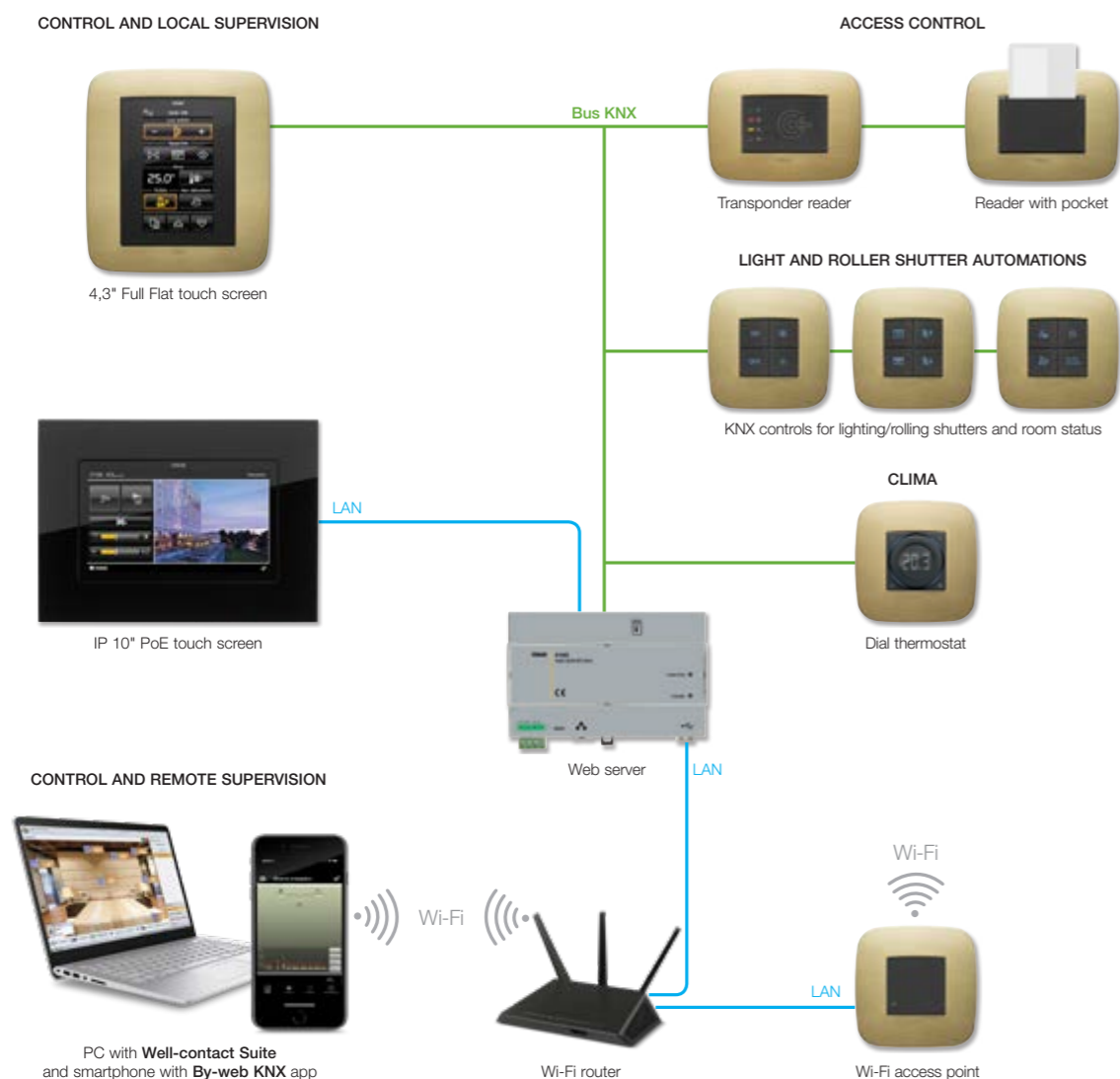

## APPLICATIONS

### CONTROL.

Raising and lowering curtains or roller shutters, selecting the climate and manage lighting, controlling access points, viewing images captured by CCTV video cameras and outdoor video entryphones. Everything can be controlled from a single point, typically a touch screen. All the functions can be controlled and supervised locally or remotely.

**Local supervision** is performed via devices installed in each room, used to locally manage the different functions (touch controls, thermostats, touch screens, etc.)

Or with supervisors (touch screen, multimedia video touch screen, etc.) which manage the building from a single control device: by selecting the various environments in the building, all the functions can be controlled.

**Remote supervision** is assured by the **Web server** which is used to manage the Well-contact Plus automation system via a PC, smartphone, tablet or touch-screen with a browser for viewing the web pages. Remote control is assured via a local LAN or Wi-Fi network to:

- supervise and control all the devices in the system;
- view the system status, events log, etc. at any time;
- control the environment via the IP video cameras.

For mobile devices the **KNX By-web App** is available (free download from Apple Store). By exploiting the Wi-Fi connection for local control and the Internet for control away from the home, it offers rapid access to the Well-contact Plus system functions.

### COMFORT.

In every environment in the building you will be able to find the conditions of comfort you prefer. Dim the lighting to create welcoming relaxation areas, move the curtains or roller shutters to give the right amount of light for various daytime activities, adjust the brightness of different (conventional and energy-saving) lamps or create interplays of light: all this is possible with one simple parameter setting.

**Scenario:** this is a function that allows the user to "call up" a preferred set of conditions via a single command or event; creating a scenario from a PC is simplicity itself.

**Event:** a programme that enables/disables groups and/or scenarios under specific circumstances and/or at selected times, according to simple logic rules governed by the control unit.

The various comfort functions include the possibility of managing **light and roller shutter automations**. Thanks to the use of programmed switches, which may also incorporate an actuator, rolling shutters can be raised and lowered (likewise Venetian blinds and the tilt of the slats) and lights can be turned on and off or dimmed, to create just the right level of comfort in every environment.

### ENERGY SAVING.

Well-contact Plus offers full integrated climate and energy control: this means that many additional functions become available, ensuring concrete advantages in terms of both economy and living comfort.

Managing energy with advanced solutions for optimising, measuring and monitoring electricity and other consumptions, managing loads to prevent black-outs from overload, controlling the smart distribution of photovoltaic energy, understanding the energy profile of the building: these provide a more conscious way of ensuring energy efficiency.

**Temperature control.** With temperature control that can be programmed in a scenario, for example, the system can be set up so that, on leaving the building, the temperature will switch automatically to stand-by mode, the roller shutters will be automatically lowered and the burglar detection alarm system activated, to prevent any unwanted and costly oversights.

The temperature can be raised or lowered as and when rooms are occupied or empty, or windows are open and closed, using the same sensors and magnetic contacts as for the burglar alarm system, which in this instance become dual-purpose, offering both control and efficiency.

In addition, the climate throughout the building can also be monitored and controlled — room by room or zone by zone — not only from a single central location, such as a touch screen, but also remotely, using a smartphone or PC.

**Energy management.** The Well-contact Plus system, on KNX standard, can be integrated with third-party systems to optimise **energy management** and avoid futile waste, by controlling loads.

For example, loads identified as non-priority can be excluded to prevent annoying black-outs, when the energy take-up exceeds the contractual values, sending the energy produced where it is needed, or promoting the **self-consumption** of energy from the photovoltaic system.

### SECURITY.

Well-contact Plus integrates with the **By-alarm** burglar alarm system, the **Elvox CCTV** video surveillance system, the **Elvox Video door video entrance panel system** and the **Elvox Automations** access control system; the building can also always be monitored remotely, via the KNX By-web app which is available free of charge for mobile devices. IT is also possible to incorporate **technical alarms** in the system to protect from gas leaks, smoke, water leaks, etc.

Per i dispositivi che lo supportano, il protocollo di criptazione **KNX secure** assicura massima sicurezza nello scambio dei dati all'interno della rete.

**SIMPLE INSTALLATION.**

Based completely on KNX technology, each device is able to directly perform the required functions; in fact, each component has resident intelligence that allows it to dialogue directly with all the devices in the network.

In fact, the **KNX standard** was developed to create decentralised systems where the interchange of signals and controls occurs exclusively at operating device level: this means that each component is able to autonomously process data and transmit and/or read signals directly on the system Bus.

In short, therefore, each structure and each application can assign the priorities that it deems necessary without having to accept "take it or leave it" solutions and in any case without jeopardizing the possibility of a future implementation designed to extend the system's functions.

Thanks to Well-contact Plus, each building can select the most suitable solution, "customizing" it to suit its requirements and ensuring the flexibility that only the common European protocol (KNX) can provide in terms of interoperability of devices and secure installation.

Single devices such as the external transponder reader, reader with pocket and thermostat, besides the typical functions of card recognition and electrical lock opening, service activation and temperature control respectively, have freely programmable inputs and outputs that make the system truly flexible. These inputs/outputs can be used to control socket outlets (courtesy lights, etc.), room service calls, alarms (bathroom ceiling pull, etc.) and energy savings (switching off the heating/air-conditioning after detecting an open window, etc.).

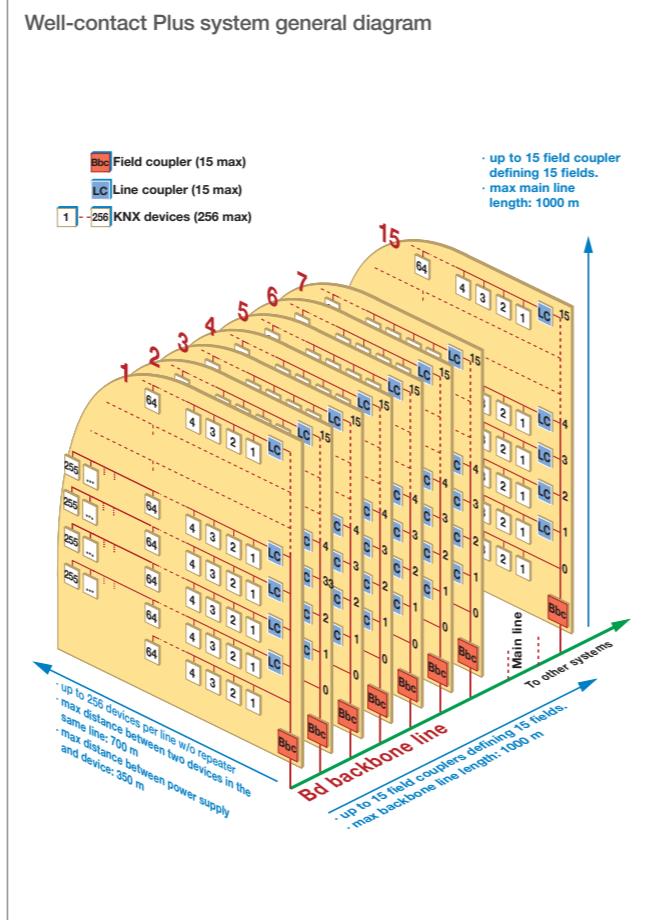
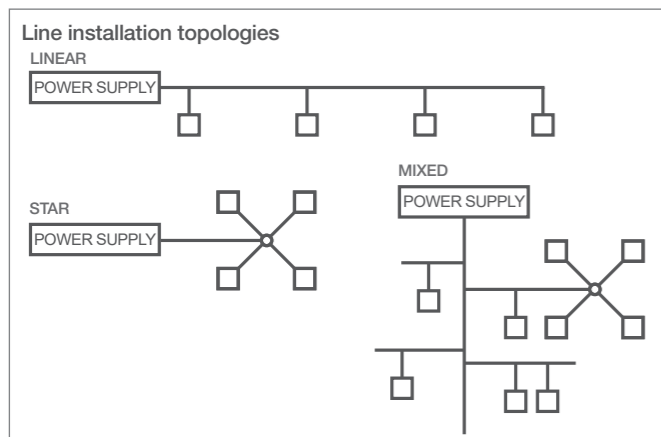
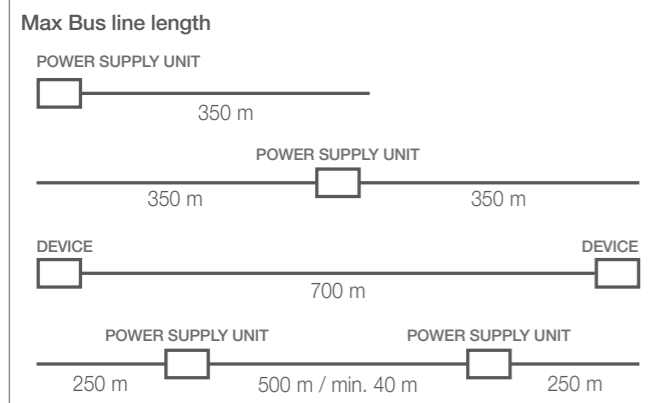

Completing the product range, there is an input/output device on DIN rail capable of managing 4 inputs and 4 outputs, all freely programmable, which can be associated with other services, such as controlled socket outlets, room signals, alarms and scenarios that activate different utilities depending on who enters the room (guest, staff, maintenance staff, etc.); this is obviously always supervised from reception where, thanks to the **Well-contact Suite software**, developed entirely by Vimar, it is possible to control all the events linked to the "history" of the guest throughout their stay.

The Well-contact Plus system uses **twisted pair transmission cables**; using the Bus cable not only simplifies the installation/maintenance operations, but also ensures a high level of immunity from interference. Information is exchanged between the devices in "telegrams" composed of a set of bits whose combinations encode the transmitted information.

For the purposes of the application functions, the most important information transmitted by each device is the following:

- the recipient address field indicating the devices which are to receive the message;
- the field containing the information about the actual function that the device must perform;
- the sender's address indicating the device that has sent the message.

Each device has a specific "physical" address that identifies it uniquely in the system and therefore there can be no identical physical addresses.

As regards the recipient address, in normal operating conditions, this always consists of a group address; via the group addresses the various components are "logically wired" so that (even highly complex) functional correlations can be established between the various devices.

Modifying the group addresses with the special ETS configuration software changes the functions of the devices (for instance associations between inputs and outputs) without making any changes to the system wiring.

The basic element in the system is the line segment: this is also the starting point for expanding the system up to the maximum possible configuration in terms of devices and shared functions

Well-contact Plus system	Characteristics	
<b>Bus devices</b>	Number of Bus devices for each single line segment	max 256
	Number of lines	max 16 per field (total 241 lines)
	Number of fields	max 15
	Number of couplers for line used as repeaters	max 3
	Max distance between device and power supply on same line	350 m
	Max distance between two devices on same line	700 m
<b>Power supply</b>	Minimum working voltage	21 Vdc
	Number of power supplies for line segments	max 2
	Max current per line	640 mA
	Minimum distance between the two power supplies	200 m
<b>Topology</b>	Permitted connections	linear, tree, star and mixed
<b>Transmission</b>	Transmission technique	decentralized, by event, serial, symmetrical
	Transmission speed	9600 baud
<b>Cable</b>	Bus cable section	2 x 2 x 0,8 mm <sup>2</sup>
	Max length per line	1000 m

**PREPARING THE SYSTEM.**

When preparing the system, it is important to have a clear idea of which functions and applications are to be created; obviously this will depend on the type and complexity of the building where the system is to be installed.

The system is composed of a range of 8 types of devices; in the configuration phase, via the ETS software you assign the “task” that each of these devices must perform, defining the input/output associations and the utilities to control.

When creating an installation with the Well-contact Plus system the following components are used:

- power supplies
- line coupler
- transponder card reader
- transponder card reader with pocket
- thermostat
- 4.3” Full Flat colour touch screen
- control with 4 and/or 6 independent push buttons
- transponder card reader/programmer
- input/output device
- USB interface

As regards the actual preparation of the system and therefore laying out the cables and positioning the devices, simply take into account the characteristics given in the table below, complying with the following precautions:

- add up the power inputs of the single devices (that must be no more than 64 for each line segment) so as to determine the number of power supplies to install; if the absorption of the devices in a line is greater than the current delivered by the power supply (for instance 320 mA) it is necessary to connect an additional power supply or use a power supply able to deliver a greater current (for instance 640 mA);
- the transponder readers and those with a vertical pocket are equipped with an additional supplementary power supply with respect to the connection on the KNX Bus 12-24 V.

**Note:** the power supply must be separate from all other loads (electrical lock, lamps, remote switches, etc.) via a dedicated transformer art. 16887, the outputs of which must be used exclusively for these two devices.

- evaluate accurately, according to the dimensions of the property, whether a line can be considered as a floor or whether a line can cover a number of floors or, vice versa, whether the building is so large that covering a floor requires a number of lines (therefore, in the design phase, take account of the characteristics of a line in terms of number of devices and distances);
- the number of lines forming the system will determine the number of couplers that must be installed (the lines are connected together by line couplers that allow communication between devices belonging to different lines);
- during the design phase it is important to determine the correct position of the various devices within the system.

In a standard hotel system, we may hypothesise the reception, dining room, administrative offices, meeting room, utility room and store on the ground floor, and the guest rooms on the upper floors.

The following must be installed in each room:

- an external transponder reader for accessing the room and displaying the messages via the 4 front LEDs;
  - a reader with a pocket for activating the associated loads (utilities);
  - a thermostat for controlling the temperature set-point;
  - a control with four independent push buttons for “do not disturb”, “room service call” and “lights control” functions;
- In the suite, in place of the control with four independent push buttons, two 4.3” Full Flat colour touch screens are installed to manage lights, climate and any scenarios.

The transponder readers are also used to discriminate accesses to the offices and other rooms (store, utility room, etc.) located on the ground floor; this shows how the Well-contact Plus system can easily be used in both hotel and service industries.

**PROGRAMMING AND CONFIGURATION FROM PC.**

The functions of each device are **programmed** using the **ETS software**; in other words, a project is created in which each room is composed of a certain number of components, each of which is in turn assigned operational parameters.

It will therefore be possible to choose, for instance, whether a relay must work in one-position stable, two-position stable, N/C or N/O mode or the type of thermostat temperature control (proportional integral, ON/OFF, etc.) or configure an input to recognise signal fronts, cyclical repetitions, etc.

ETS also enables Well-contact Plus devices to interact with other KNX appliances not supplied by Vimar, not only to make the system suitable for the widest range of applications, but also so that it can be integrated with existing devices (renovations).

The main competitive characteristics of the Well-contact Plus system can be summarized as follows:

- no centralized smart room module is necessary;
- all the functions and “intelligence” of the system are distributed over the various devices;
- the flush-mounting devices that must be installed in the room are equipped with free inputs and relay outputs that reduce the need for additional terminals;
- the system is extremely flexible thanks to the modular design of the range and its potential for easy, low-cost expansion to meet future needs;
- extremely simple, flexible system management software that also allows interfacing with the most widely used administrative software.

The **ETS software** (Engineering Tools Software) is **marketed by KNX Association**. With the ETS software, you address the different devices operating in the system and establish the related functional correlations (or group addresses).

Establishing the functional correlations means using software to define how each device must intervene following the events occurring in the system, for instance which lamp or group of loads must switch on when a card is inserted in the reader with pocket or a particular 1-way switch is pressed.

The operating mode of KNX appliances is also determined by the application selected from those available for that device and by the appropriate configuration of the relative operating parameters.

The KNX device applications are freely available on the website [www.vimar.com](http://www.vimar.com).

The addresses and operating parameters are transferred to the various devices by connecting the PC to the KNX Bus via the KNX USB interface 01540.1 or IP 01547.1 and 01548.

The ETS software uses simple graphical user interfaces that facilitate device configuration also in relation to the building layout. To purchase the ETS software, obtain a free “demo” version or receive more technical and commercial information we suggest you contact the KNX Association.

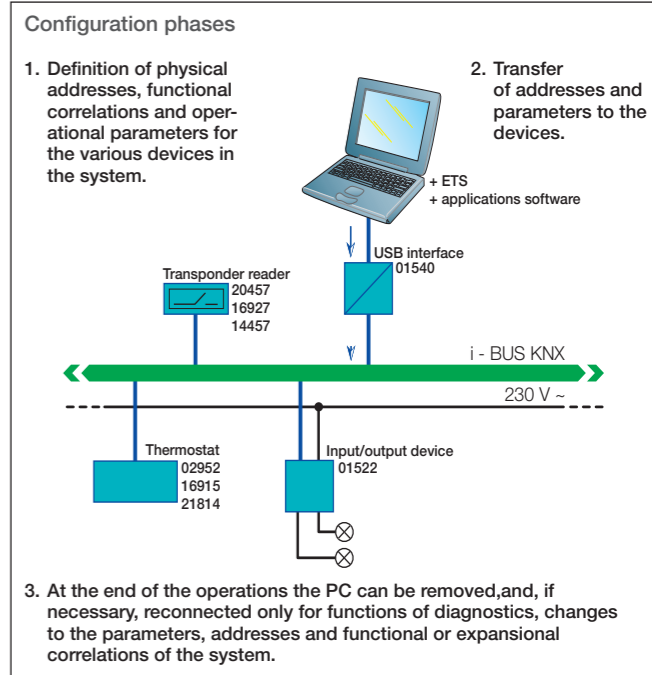

ETS software window

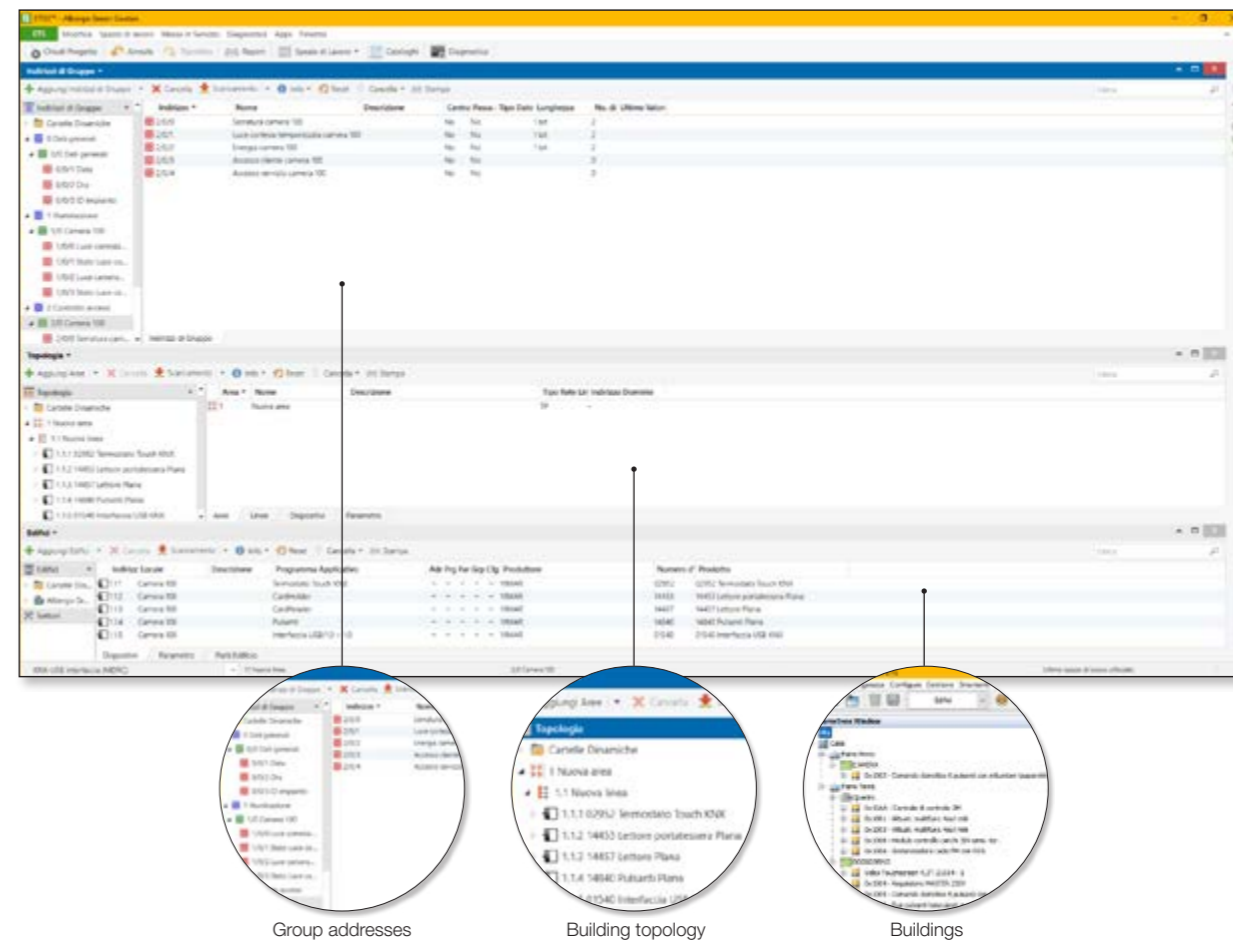







**Note.** In a Well-contact Suite system, when using the ETS project, there must be no groups with the same name: for example we need to differentiate “energy room 101” from “energy room 102”. Creating an ETS project in compliance with this clause will enable the Well-contact Suite software to automatically distinguish between the group addresses it must display and the ones it must mask for each room, considerably facilitating the task of environment/room creation with Well-contact Suite.

**SUPERVISION AND CONTROL FROM PC.**

As already mentioned the KNX distributed intelligence systems also enable supervision and control at a higher level (centralized). The use of PCs and special software enables the centralization of the system's functions, but in no way jeopardizes their operation if the PC is switched off or malfunctions.

**WELL-CONTACT SUITE (WCS) SOFTWARE.**

To meet the needs of the various types of systems used by its customers, Vimar has created a family of software products for managing and supervising the Well-contact Plus system. The following table lists the six types of application.

	<b>Light:</b> for managing a building with a maximum number of <b>15 environments*</b> from a single station. Five levels of password-activated access allow for customisable control. For example, the facility manager can access the complete system to supervise, edit parameters and program the functions, whereas the receptionist has a different password and only has access to some of these operations. Can be interfaced with only one Client (art. 01592). * The term environment refers to a room, office or common area in the facility with an external and internal transponder card reader.
	<b>Basic:</b> for managing a building with a maximum number of <b>50 environments</b> from a single station. Five levels of password-activated access allow for customisable control. For example, the facility manager can access the complete system to supervise, edit parameters and program the functions, whereas the receptionist has a different password and only has access to some of these operations. Can be interfaced with a maximum of one WCS Client 01592
	<b>Top:</b> for controlling large hotels with a <b>potentially unlimited number of rooms and stations</b> . This application has 7 password levels and offers the use of the planner for supervising arrivals and departures. Can be interfaced with an infinite number of WCS Client stations 01592
	<b>Client:</b> hotel application licence used to manage Light, Basic and Top systems from a second PC via connection to the network of the PC where the Light, Basic or Top application is installed. Used to manage bookings, check-ins and supervision at the same time.
	<b>Office:</b> dedicated to offices and business/sales structures, it enables the user to manage the functions of a <b>potentially limitless number of environments</b> from one station. With 7 password levels, control can be targeted and secure. Can be interfaced with an infinite number of WCS Client Offices (art. 01594).
	<b>Client Office:</b> Office application licence used to access the programme from a remote station via the network of the PC where Office is installed (art. 01593). Used for simultaneous supervision.
	<b>ERP:</b> for interfacing with administration management software. Allows the ERP software to be used for making bookings, checking in and out and the subsequent automatic transfer to Light, Basic or Top applications which manage the Well-contact Plus system. Contact Vimar to verify the possibility of interfacing it with the required ERP software.

**SUITE APPLICATIONS.**

The WCS software is used to carry out the following operations:

- management of bookings (hotel version);
- management of user records;
- management of the facility's staff records;
- management of user and staff accesses into the various environments of the facility: creation of the cards for the access control system, management of the transponder readers of the part of the system that deals with access control, creation of lists with access log;
- supervision of the automation system: climate control, activation of electric loads (lights ON/OFF, dimmer lights, relays,...), access control management, alarm management, creation of scenarios, scheduling of scenario activation, reaction of decision-making logic elements.

For the purposes of security management, the Well-contact Suite software adopts the following strategies:

- access to the software is allowed only for users previously configured in the software;
- seven levels of software access "privileges" to be associated with the software users;
- encrypted data communication between the system file server and client systems;
- encrypted "sensitive" data (e.g. software user passwords);
- encrypted data communication between the system and the card programmer;
- use of Mifare® Standard cards;
- readers and pockets can store up to 2000 different types of card at the same time. Well-contact Suite can manage a maximum of 999,999 cards with the following profiles:
  - 999,000 cards with "Guest" profile;
  - 499 cards with "Staff" profile;
  - 99 cards with "Maintenance Staff" profile;
  - 99 cards with "Security staff" profile;
  - 99 cards with "Installer" profile;
  - 99 cards with "Assistance staff" profile;
  - 99 cards with "Director" profile.

The main characteristic of the Well-contact Suite software is to automatically create graphic windows in the supervision section. These windows show all the areas in the hospitality facility with graphic symbols representing the main functions of the automation system devices in the various environments. The environments are divided up according to their use: bedrooms, common areas and technical areas. For each type of environment there are one or more of the following "theme views". A theme view is a representation of the environment highlighting a particular function of its devices.

The "theme views" envisaged in the Well-contact Suite software comprise:

- "Thermostats" view;
- "Guest in room" view;
- "Window open status" view;
- "Room cleaning status" view.

Besides the theme views, a "summary view" is created automatically, in which the main data of the environment are shown.

The Well-contact Suite software automatically creates a window with a "detailed" view of the environment featuring the graphic symbols for its main functions. The types of functions presented automatically in the detailed view of the environment and their characteristics can be customised according to the user's specific needs.

In any case, the supervision windows created automatically by the Well-contact Suite software can be customized to satisfy the user's requirements.

The Well-contact Suite software **enables users to view the alarm events created by the Well-contact Plus system**, send an alarm "reset" command to the system and create a log for these events. Lastly, different types of alarm can be defined together with the corresponding display priorities.

Via the **Client** licence (art. 01592) it is possible to **simultaneously manage a second PC** connected to the same network (bookings, check-in and check-out).

With the **ERP** licence (art. 01595) **it is possible to interface the most common ERP software** to the Well-contact Suite software.

**FUNCTIONS MANAGED BY THE SUITE.**

Card identification
Guest Room Check-in\Check-out
Management of Services and Privileges (creation of cards enabling services)
Access log and display
Stopping access to single rooms
Room booking
Displaying reserved, booked, occupied rooms, identification of guest presence
Displaying length of stay, day of departure
Checking PW of personnel with hourly and area limitation
Diversification of users (guests, service staff, etc.)
Viewing of different types of alarms and modifying the signalling status
Protection with unique Hardware Key for guest
Searching and exporting entry reports
Checking and managing transit through common areas
Advanced search functions (by text categories)
Displaying service requests
Managing the records of the guests and hotel staff
Guest log with any saved parameters
Supervision (temperatures, I/O, alarms, security, lights)
Guest management with Client-Server Logic on local area network or remotely via web
Levels of protection (password) for differentiated accesses
Seven levels of access "profiles" to be associated with the software users
Possibility of managing scenarios and commands of virtual devices



**SUPERVISION AND CONTROL FROM APP.**



Vimar has developed the **KNX By-web app** which, by connecting remotely to the **Web server** (art. 01545) in the Well-contact Plus automation system, is used to supervise the whole KNX home automation system from smartphone.

Simple and intuitive icons are used to control – from a LAN Wi-Fi network at home or an Internet network when away from home – lights, roller shutters, automations; lighting and sound system control, as well as the control of electrical loads.

It is also possible to check the status of the installed devices at any time. With KNX By-web the user's interaction with the building is even stronger.

The app is download for free from the main stores.



**PUSH BUTTON OPERATED DEVICES.**

The Well-contact Plus system push button device are essentially divided into the following categories:

- **Eikon Tactil home automation devices** with suitable for activating scenarios, or controlling dimmable lights and roller shutters;
- **Eikon Exé Flat home automation devices** for management of lighting (dimmable too), rolling shutters and for scenario activation;
- **universal home automation controls** for Eikon, Arké and Plana, customisable with button covers in the relative series, with 4 or 6 push buttons, for controlling lights, roller shutters and scenarios.

These devices allow services to be controlled by way of a logic connection with relay actuators connected to the services themselves; except in the case of scenarios, each device is connected logically to an actuator that must be selected according to the utility being controlled.

On this basis, the two categories mentioned are further divided into the following types of controls:

- Eikon Tactil home automation devices with 4 or 6 programmable push buttons;
- 2 or 3 rocker button controls;
- 2 or 3 rocker button controls with actuator;
- 2 or 3 rocker button controls with slat/roller shutter actuator.

With different types of controls available, installers have the greatest possible freedom in terms of configuration: for example, the actuator for operating a switched socket outlet can be associated directly with the push button.

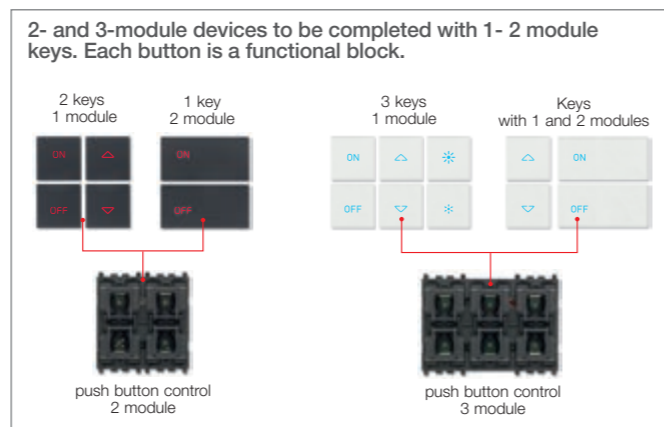

**Examples of Eikon Tactil home automation control installation**

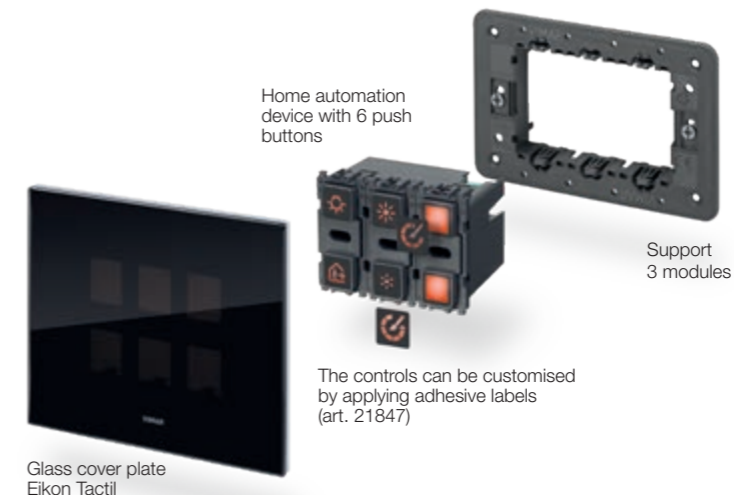

**Example of installation of 1-module half-button caps on Eikon Exé Flat home automation control**

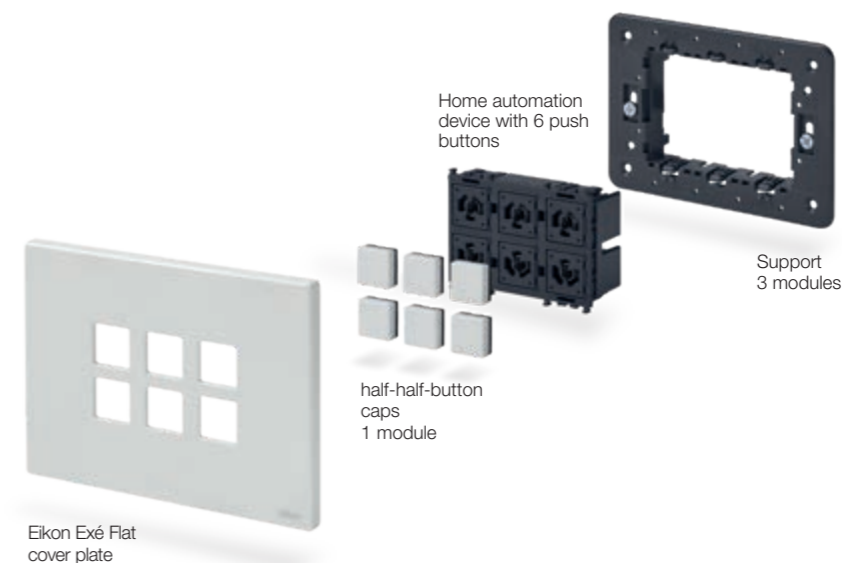

**Example of installation of 1- and 2-module half-button caps on universal controls for Eikon, Arké and Plana**

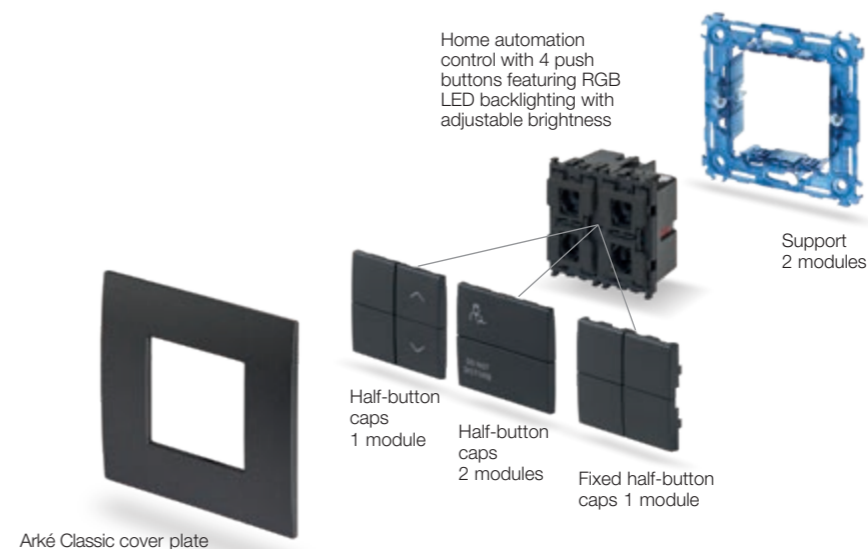

**Typical system: 160 m<sup>2</sup> villa with KNX automation system (lights and roller shutters), climate control by area and supervision.**

The example shows an automation system with KNX devices to manage lights and roller shutters, climate control and supervision of the whole system from touch screen or mobile devices, in a 160 m<sup>2</sup> villa.

- Controls 01580 are installed in the lounge to switch lights On/ Off and move roller shutters Up/Down, as well as a IP 7" PoE touch screen to supervise the system and control the climate.
- Dial thermostats and controls for managing the lights and roller shutters are installed in the kitchen and the bedrooms.
- Temperature probes 20432 are installed in the bathrooms, connected to the dial thermostats in the two bedrooms.
- In the utility room, in addition to the actuators for DIN rail that manage the lights and roller shutters, there is a Web server

01545 used, through a connection to the Wi-Fi router, to supervise the whole system from the local network or remotely using a mobile device such as a PC, tablet or smartphone.

- Outside, the weather station 01546 is installed; this is integrated with the Well-contact Plus home automation system to manage the temperature control, energy and automations (for example, sun blinds, outdoor lighting and garden irrigation). The device measures the outdoor temperature, wind speed, rain and brightness, and these values are read by the supervisors and can manage the automation (in case of strong wind the blinds rise up).



IP 7" PoE touch screen for managing automations and climate control.



KNX home automation controls for managing lights and roller shutters.



KNX touch screen thermostat for climate control.

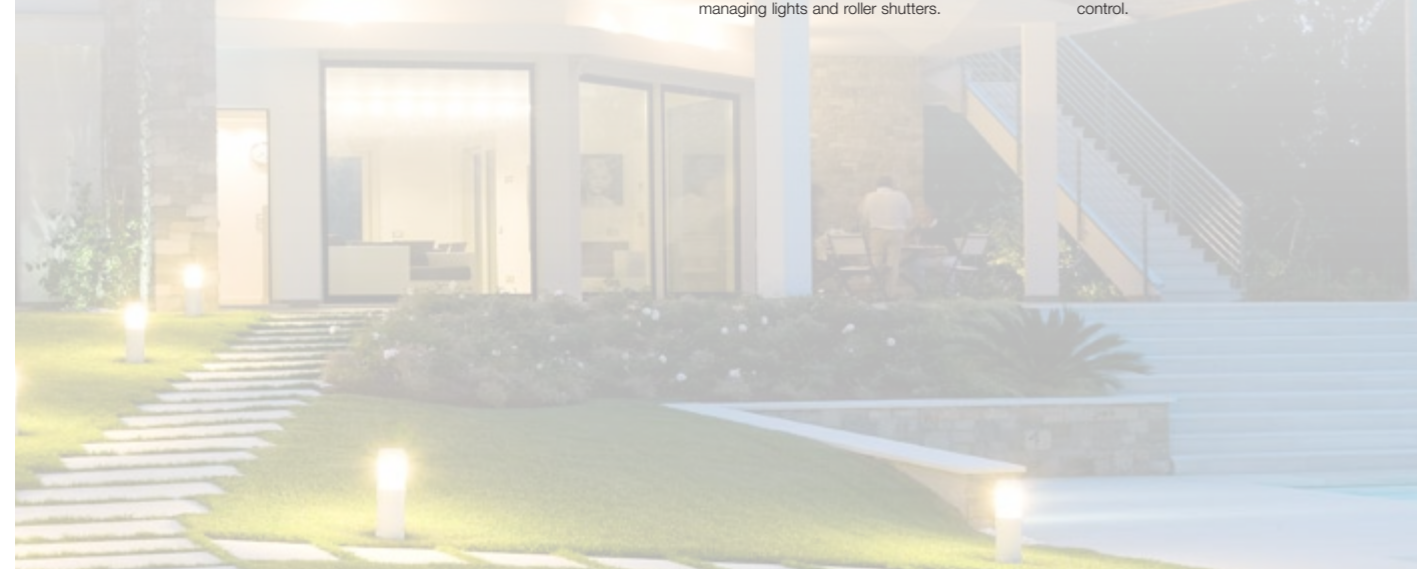

Typical system: 160 m<sup>2</sup> villa with KNX automation system (lights and roller shutters), climate control by area and supervision.

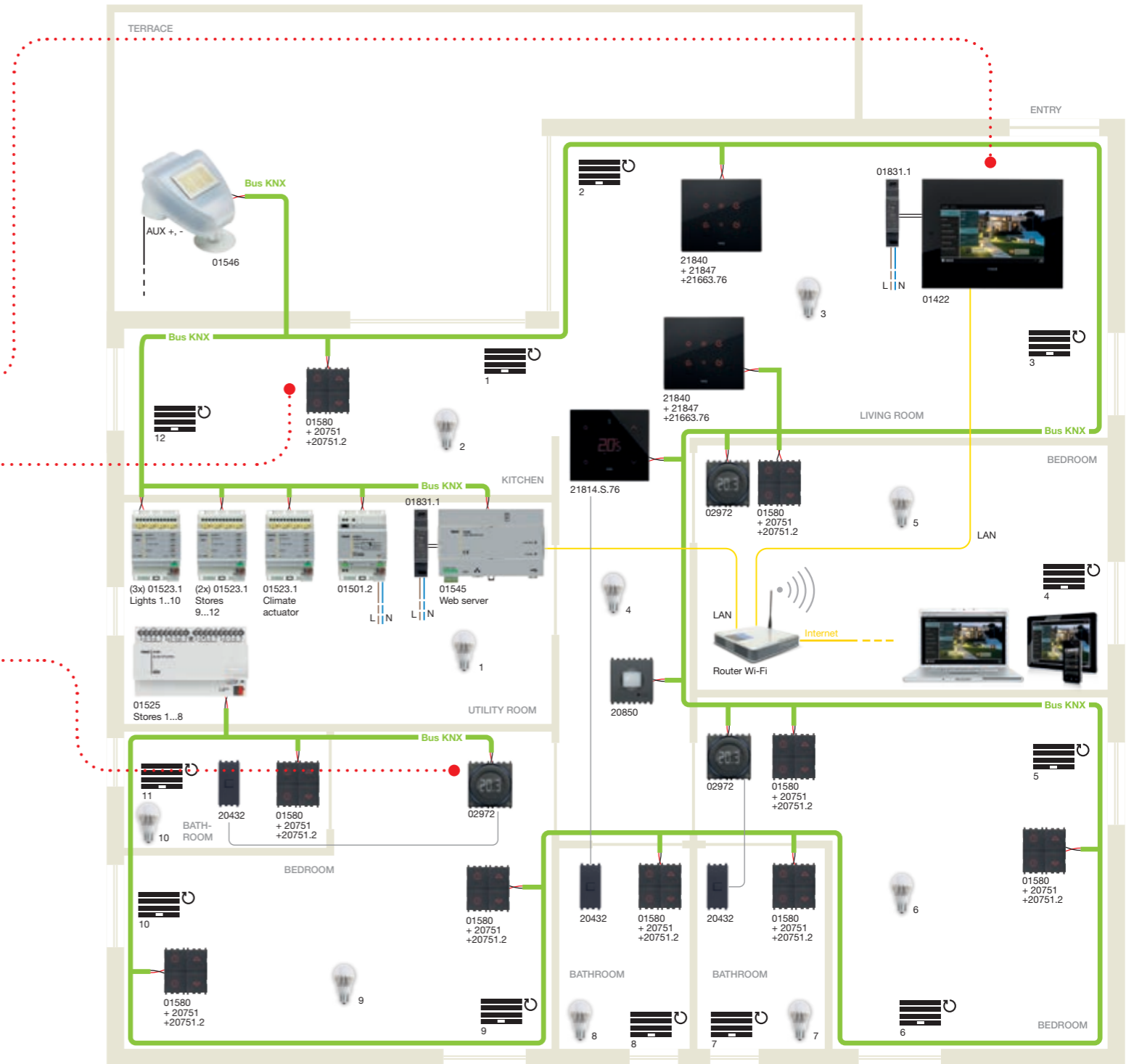

— KNX Bus — Probes connection — Power supply 230 V- — Auxiliary power supply — LAN connection

**Typical system: offices with KNX system for lighting control (presence and brightness sensors), climate control and supervision.**

The example shows the lighting control based on presence and brightness sensors in the service industry using the Well-contact Plus system developed to KNX standard.

Using these devices ensures energy saving and optimal lighting in the working environment.

- In the offices, meeting rooms and multimedia rooms, the IR detectors with brightness sensor 01527 are used to control the lighting system according to the level of brightness outdoors and the people moving about in the room (motion-activated).
- DALI drivers are installed in the multimedia rooms to control 4 lamps operated via KNX DALI gateway 01542 in the utility room, adjustable via the constant brightness control by the sensor 01527.

- Flush-mounting IR detectors 14850 are installed in the bathroom and utility room to control the timer-operated light.
- Dial thermostats are installed in every office. Some thermostats are connected to magnetic contacts that signal if a window is open and thus automatically switch off the heating to ensure greater energy saving.
- Every room is fitted with 4 push button home automation controls 01580 for switching the lights On/Off and controlling the roller shutters; in offices 1, 2 and 3, 6-button home automation controls with on-board relay are used to control the roller shutters and tilt the slats.
- The whole system is supervised from the PC in the reception area with Well-contact Suite software installed.

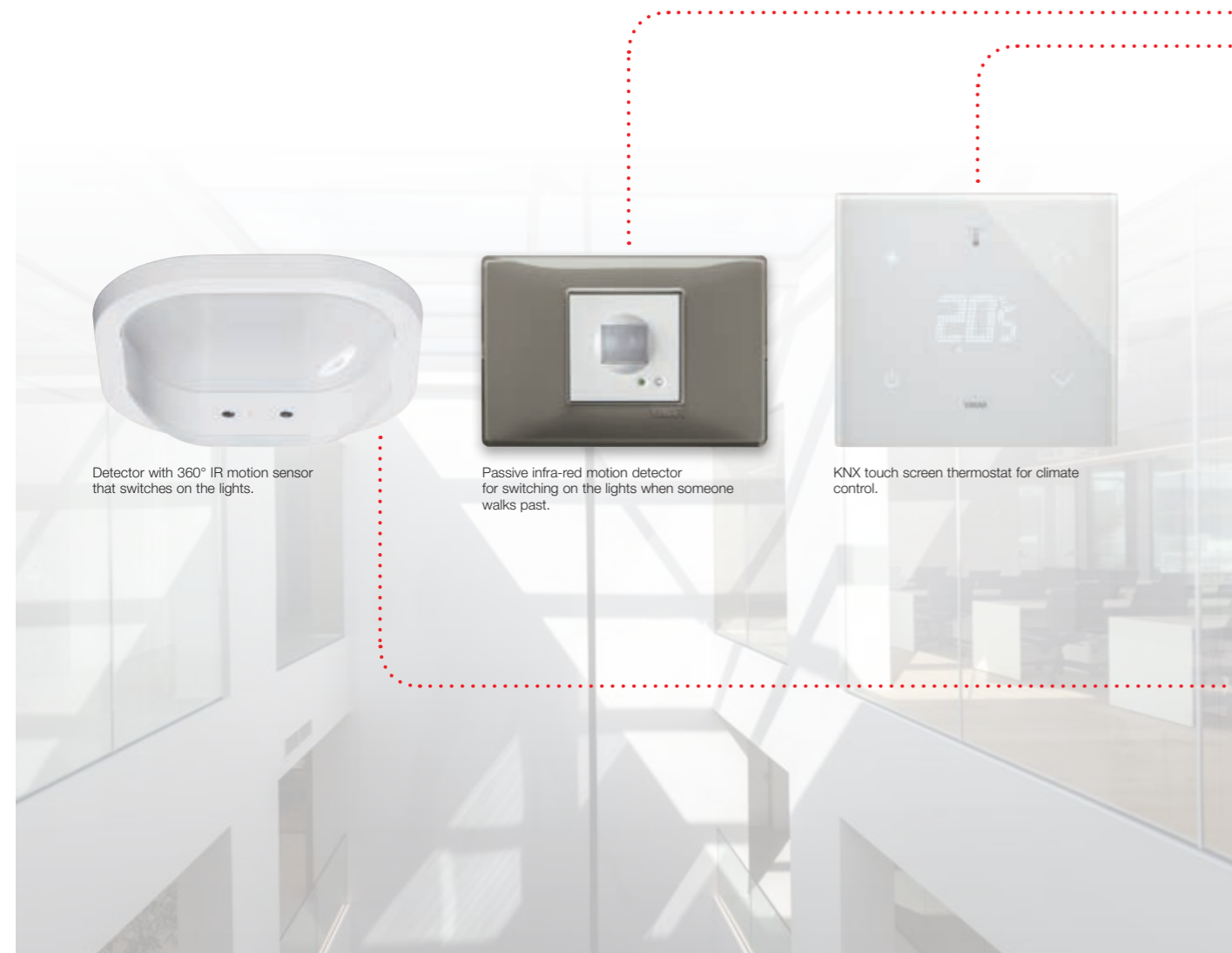

Typical system: offices with KNX system for lighting control (presence and brightness sensors), climate control and supervision.

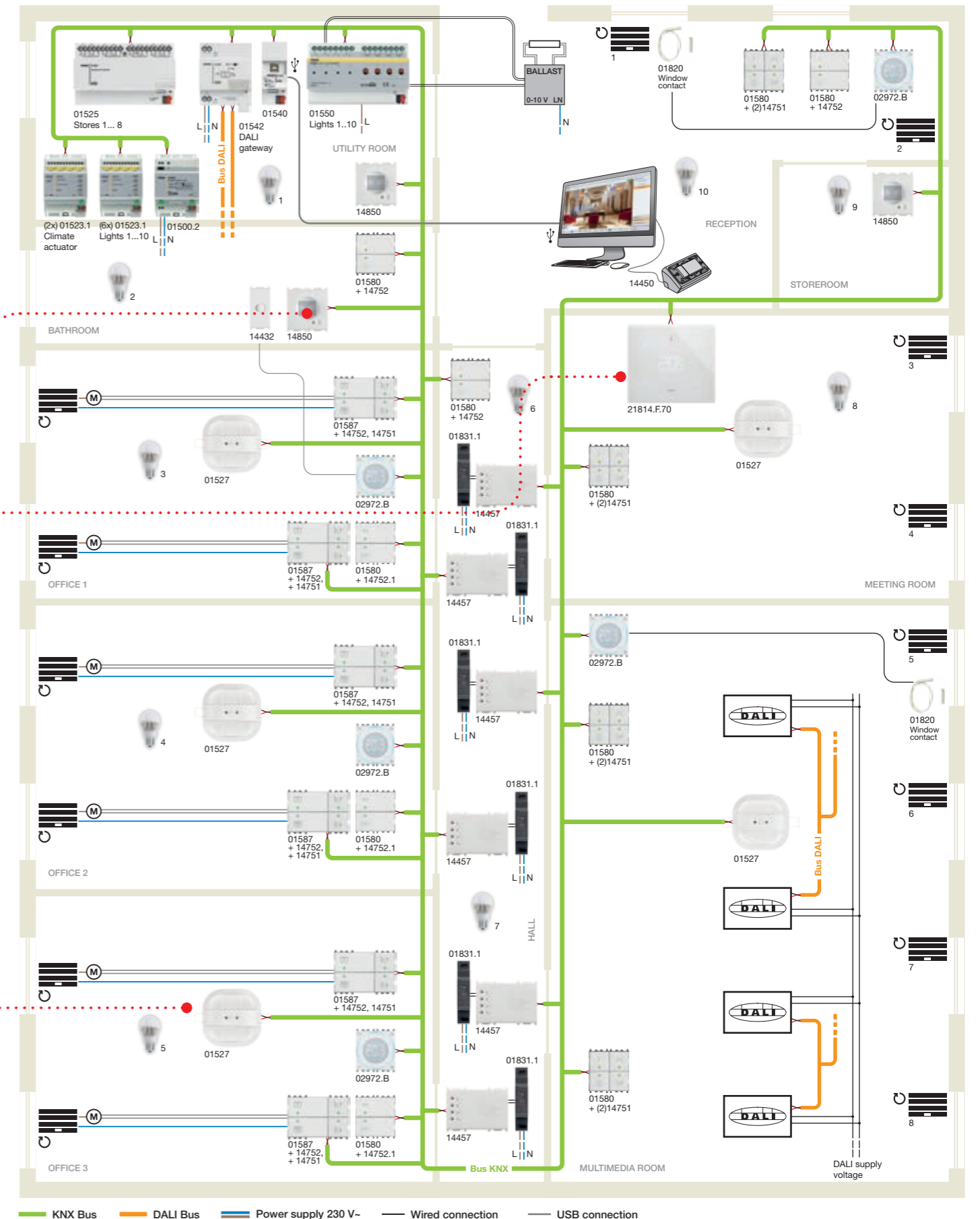



**Typical system: hotel with KNX system for controlling accesses, automation (lights and roller shutters) and climate control.**

The example shows a Well-contact Plus system in a hotel where the check-in/check-out functions are managed from the PC at reception with Well-contact Suite software installed. The transponder readers installed outside the rooms are associated with the following room status signals:

- guest in room;
- room occupied or "Do not Disturb";
- "please clean" the room;
- card recognition signalling.

In the rooms, once the card is inserted into the vertical pocket, the lights and heating are activated and the presence of the guest is promptly signalled in the system.

The magnetic contact installed signals whether the window is open, if so automatically switching off the heating to ensure greater energy saving (no air conditioning actuators are installed because different depending of the system). Finally, the KNX home automation controls 01581 (with built-in actuator) and 01580 are used to manage the lights or call for room service rather than have the room cleaned.



KNX dial thermostat for climate control.

Transponder card reader.

KNX home automation controls

KNX dial thermostat for climate control.

Transponder card reader.

Typical system: hotel with KNX system for controlling accesses, automation (lights and roller shutters) and climate control.

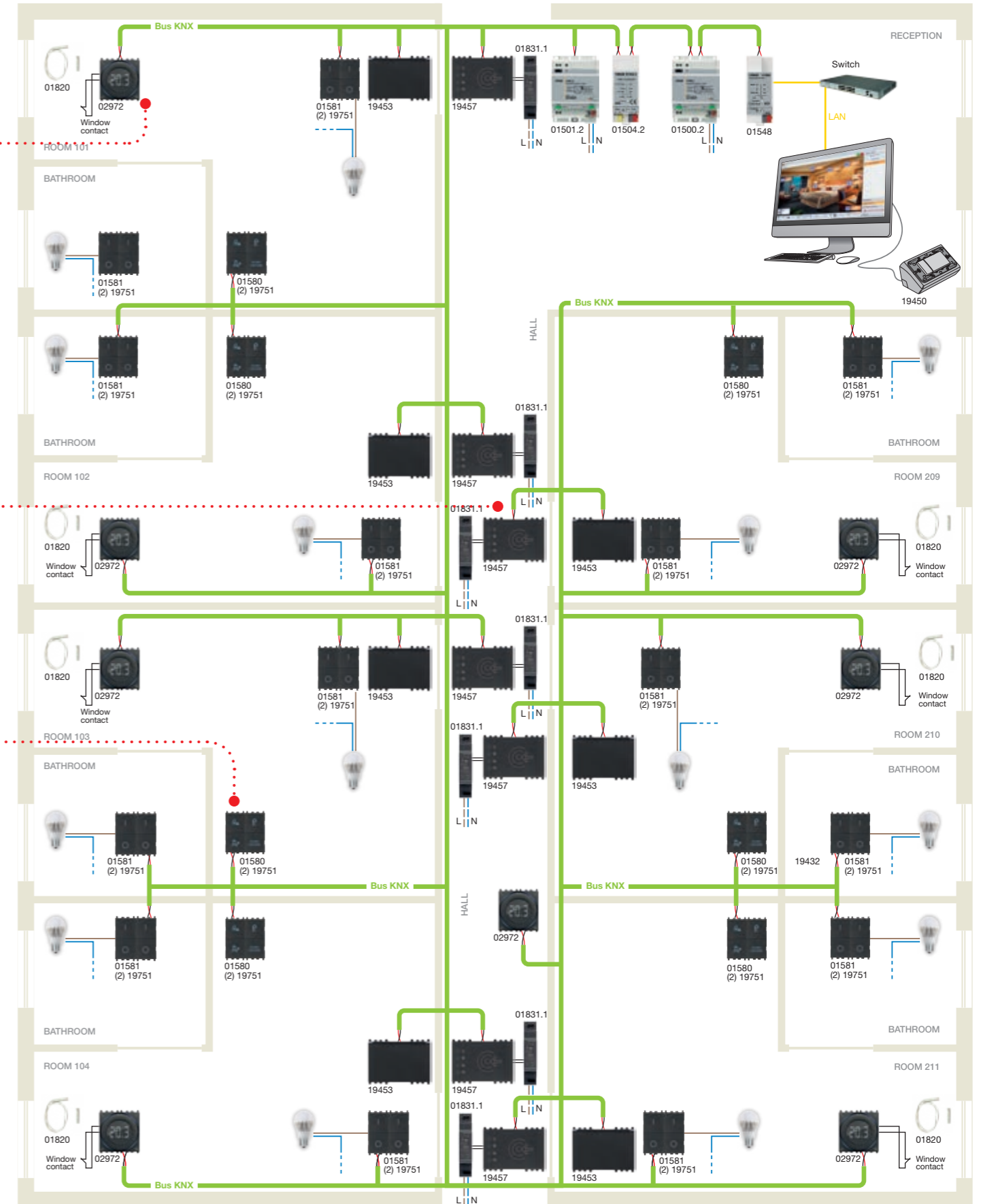

— KNX Bus — Probes connection — Power supply 230 V- — Wired connection — LAN connection — Auxiliary power supply 12 V

**Typical system: school with KNX system for lighting control (presence and brightness sensors), climate control.**

The example shows the lighting control based on presence and brightness sensors in the service industry using the Well-contact Plus system developed to KNX standard.

Using these devices ensures energy saving and optimal lighting in the working environment.

- In the classrooms, library and multimedia rooms, the IR detectors with brightness sensor 01527 are used to control the lighting system according to the level of brightness outdoors and the people moving about in the room (motion-activated).
- DALI drivers are installed in the multimedia rooms to control 4 lamps operated via KNX DALI gateway 01542 in the utility room, adjustable via the constant brightness control by the sensor 01527.

- Flush-mounting IR detectors 14850 are installed in the bathroom and utility room to control the timer-operated light.
- Dial thermostats are installed in every classroom. Some thermostats are connected to magnetic contacts that signal if a window is open and thus automatically switch off the heating to ensure greater energy saving.
- Every room is fitted with 4 push button home automation controls 01580 for switching the lights On/Off and controlling the roller shutters; in classrooms A, B and C, 6-button home automation controls with on-board relay are used to control the roller shutters and tilt the slats.



Typical system: school with KNX system for lighting control (presence and brightness sensors), climate control.

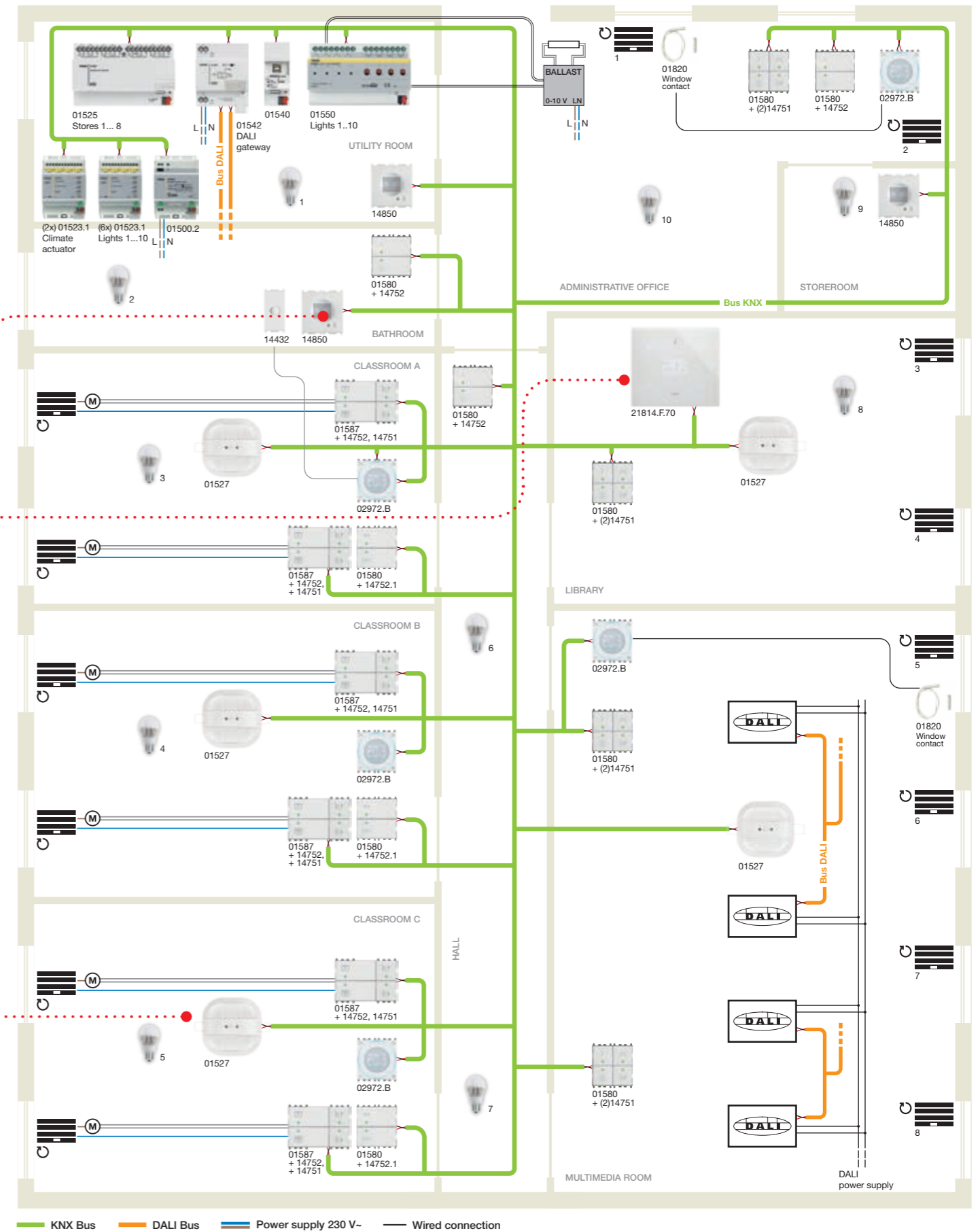

**Typical system: hotel with home automation system Well-contact Plus KNX integrated with access systems on third-party electronic handle.**

The example shows a Well-contact Plus KNX home automation system in a hotel integrated with third-party electronic lock systems.

In each room, the lights and roller shutter automation is managed by KNX 01581 controls with on-board actuator; the device with 4 inputs and 4 outputs for DIN rail 01522.1 is used to manage the minibar load and the room service call button, to signal if the door is opened and control the fan-coil motor.

The KNX dial thermostat (02972) controls the temperature in the room and, as it is connected to the window contact (01820) that signals if the window is open, it automatically switches off the heating to ensure greater energy saving.

The connected NFC/RFID reader, if in stand alone configuration, it reads only Mifare cards, because is a typical standard in access control system producers. The clean-contact output connected to KNX system by 01522.1, it will activate the presence in room status visualized on the supervision PC. The whole KNX system is monitored from reception using a PC with Well-contact Suite software installed, while the accesses are managed by third-party system.



NFC/RFID pocket.

KNX dial thermostat.

KNX home automation controls.



Typical system: hotel with home automation system Well-contact Plus KNX integrated with access systems on third-party electronic handle.

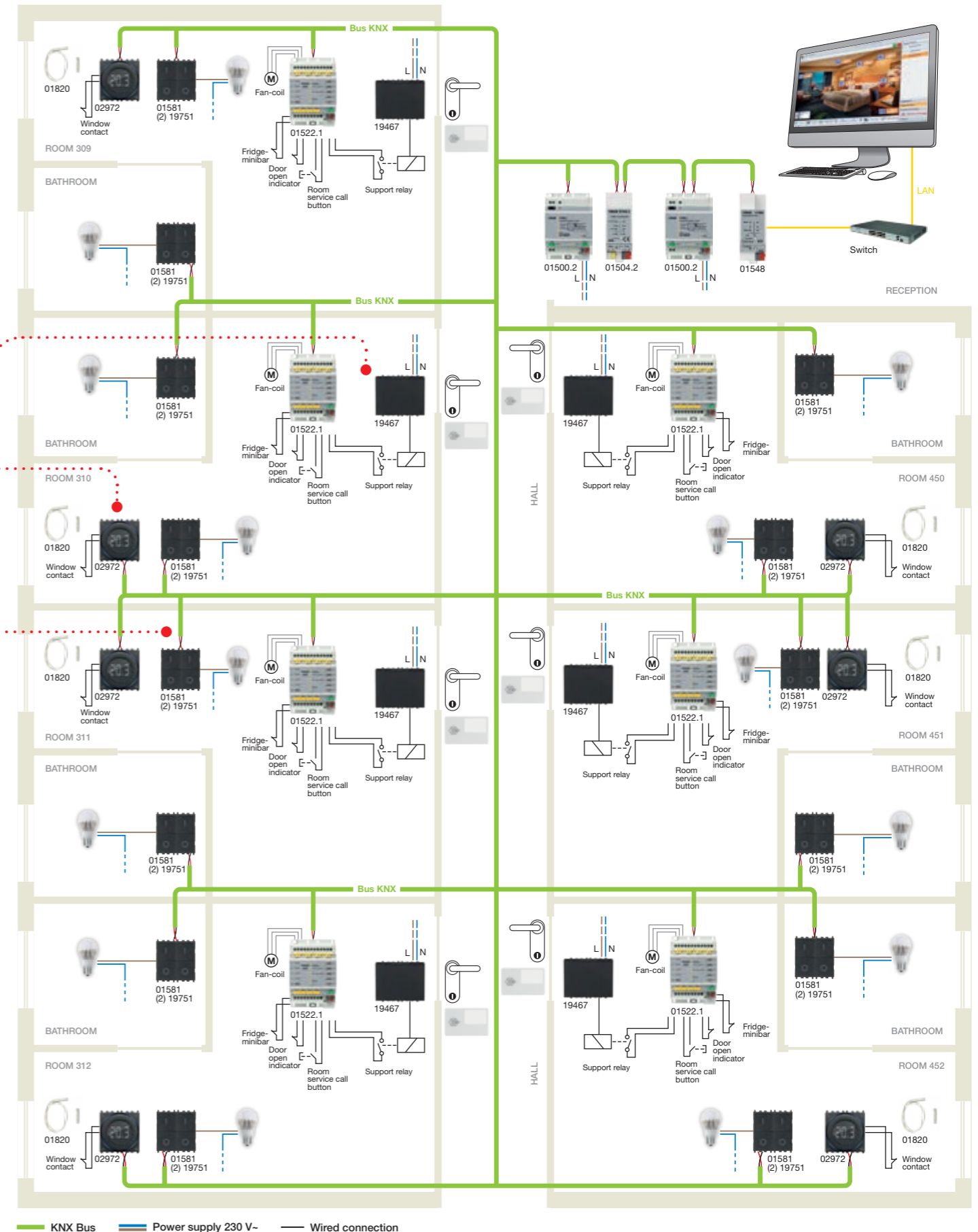

### Typical system: hotel room with KNX system integrated with View wireless devices for lighting, rolling shutters, temperature and room status control.

The example shows an hotel room with KNX system integrated with View Wireless devices where dove:

- out of the room, it is installed a "Do Not Disturb" and "Please Clean" push button (art. 20097) that signals to the hotel staff the room status. The 2 indicators of the push button can be activated from 2 customised controls inside the room (art. 20005);
- inside the room, it is installed 4 connected 2-way switches (art. 20592.0), 2 for ceiling lamp and LED strips switching on and 2 for the bathroom lighting;
- on the bedhead, it is installed 2 reversing switches (art. 20013), 2 2-way switches (art. 20005) and 2 OFF push buttons (art. 20008) controlling the room lighting and a connected device (art. 20594.0) for up/down the rolling shutters;
- the temperature is controlled by dial thermostat 02972;

- in the room, it is installed an IoT Bluetooth Wi-Fi gateway (art. 20597) that enables the intercommunication between the devices;
- in the room switchboard, it is installed a DIN rail device for 4 inputs /4 outputs (art. 01522.1) as a control of lighting and rolling shutters and door open signalling and an alarm from the bathroom. In addition, this device can supervise the room depending on the presence of a person, the opening of a door, welcome and general OFF scenarios.



Switches for activating the two pilot lights "Do Not Disturb" and "Please Clean" for the special push button installed outside the room and connected 2-way switches to activate room lighting.



Push button Do Not Disturb" and "Please Clean" placed outside the room.



Wi-Fi Bluetooth gateway.



Connected 2-way switch to control rolling shutters, OFF push button and 2 reversing switches to control room lighting.

Typical system: hotel room with KNX system integrated with View wireless devices for lighting, rolling shutters, temperature and room status control.

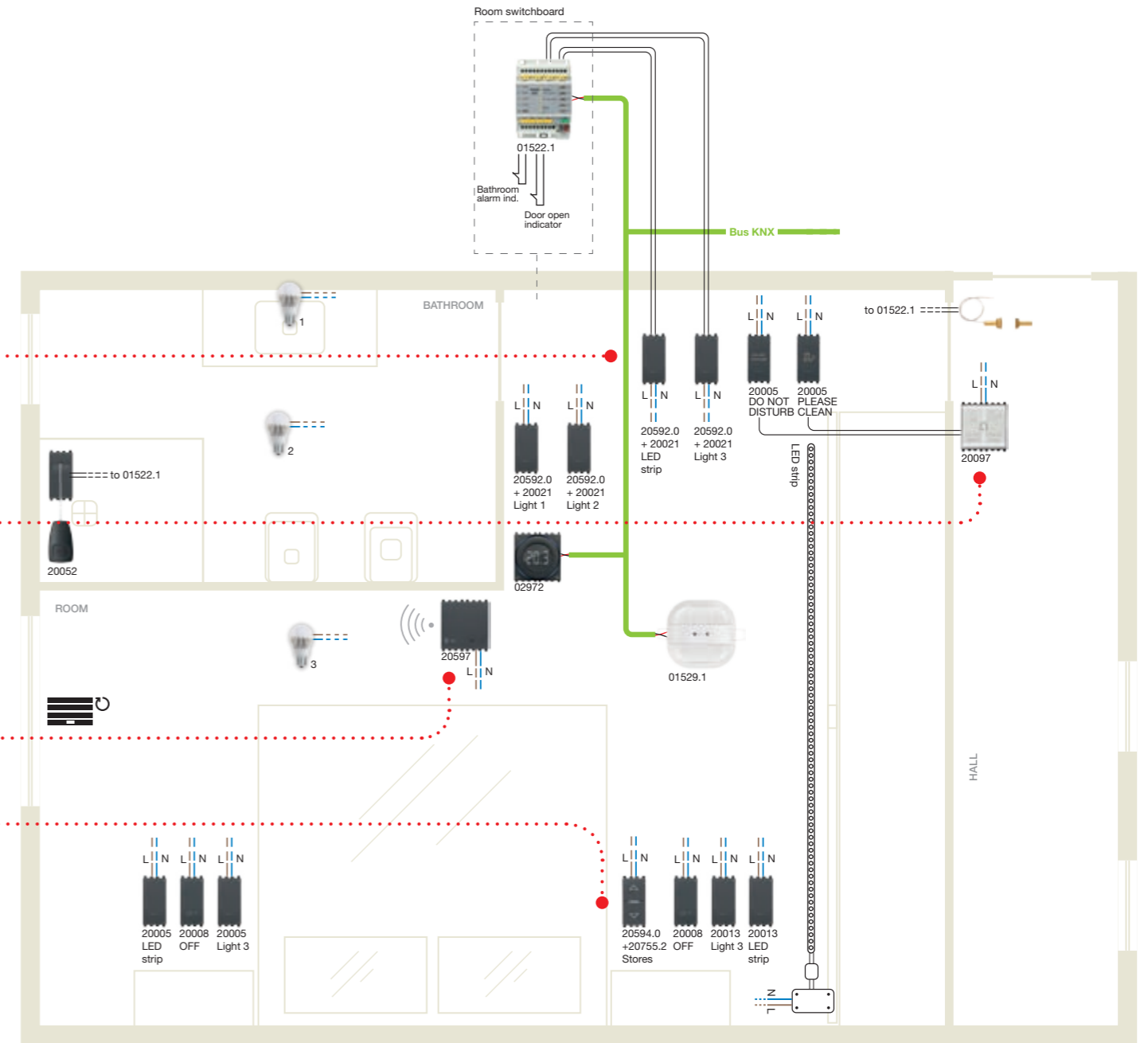

— KNX Bus — Power supply 230 V- — Wired connection

Supervision



**01425\*\*\***  
10" IP colour touch screen, used as a home automation system supervisor, IP/Due Fili Plus internal video entryphone, IP video camera and CCTV system manager, power supply PoE or 12-30 Vdc, surface mounting with bracket on round, 3-module (horizontal or vertical), 8-module (4+4) or British standard square mounting box, black. To be completed with one of the cover plates shown beside



**21665.11**  
Aluminium cover plate.  
Dimensions: 345x250 mm



**21665.70**  
Crystal cover plate, white diamond.  
Dimensions: 345x250 mm



**21665.76**  
Crystal cover plate, black diamond.  
Dimensions: 345x250 mm



**01422\*\*\***  
Touch screen with 7" IP capacitive colour display, used as a home automation system supervisor, IP/Due Fili Plus internal video entryphone, IP video camera and CCTV system manager, power supply PoE or 12-30 Vdc, surface mounting with bracket on round, 3-module (horizontal or vertical), 8-module (4+4) or British standard square mounting box, black. Cover plate supplied



**01422.B\*\*\***  
Touch screen with 7" IP capacitive colour display, used as a home automation system supervisor, IP/Due Fili Plus internal video entryphone, IP video camera and CCTV system manager, power supply PoE or 12-30 Vdc, surface mounting with bracket on round, 3-module (horizontal or vertical), 8-module (4+4) or British standard square mounting box, white. Cover plate supplied



**01420\*\*\***  
Touch screen with 4,3" IP capacitive colour display, used as a home automation system supervisor, IP/Due Fili Plus internal video entryphone, IP video camera and CCTV system manager, power supply PoE or 12-30 Vdc, with built-in 8 (4+4)-module mounting frame, to be completed with Eikon, Arké or Plana cover plate, black



**01420.B\*\*\***  
Touch screen with 4,3" IP capacitive colour display, used as a home automation system supervisor, IP/Due Fili Plus internal video entryphone, IP video camera and CCTV system manager, power supply PoE or 12-30 Vdc, with built-in 8 (4+4)-module mounting frame, to be completed with Eikon, Arké or Plana cover plate, white



**01420.BN\*\*\***  
Touch screen with 4,3" IP capacitive colour display, used as a home automation system supervisor, IP/Due Fili Plus internal video entryphone, IP video camera and CCTV system manager, power supply PoE or 12-30 Vdc, with built-in 8 (4+4)-module mounting frame, to be completed with Eikon, Arké or Plana cover plate, neutral



**21848.1**  
Color touch screen, 4,3", Full Flat, for the control, 1 temperature sensor input, with built-in mounting frame for installation in 8-module mounting box, grey. Depth: 40 mm



**21848.1.B**  
Color touch screen, 4,3", Full Flat, for the control, 1 temperature sensor input, with built-in mounting frame for installation in 8-module mounting box, white. Depth: 40 mm



**21848.1.BN**  
Color touch screen, 4,3", Full Flat, for the control, 1 temperature sensor input, with built-in mounting frame for installation in 8-module mounting box, neutral. Depth: 40 mm

\*\* App available for iOS and Android operating system, free download from Apple Store and da Google Play.

\*\*\* Using the **Webview** function, it is possible to supervise a KNX system equipped with a Webserver from the Vimar touch screens.

Supervising



Kit software for Well-contact Plus system management  
**0K01590:** Suite Basic software + Client Basic licence + hardware key



Kit software for Well-contact Plus system management  
**0K01590.1:** 1 desktop personal computer + Suite Basic software + Client Basic licence + hardware key  
**0K01591:** 1 desktop personal computer + Suite Basic software + Client Top licence + hardware key



Software for Well-contact Plus system management  
**01589:** Well-contact Suite Light  
**01592:** Well-contact Suite Client  
**01593:** Well-contact Suite Office  
**01594:** Well-contact Suite Client Office  
**01595:** Additional software for interfacing with existing management system



**01597:** USB spare key for Well-contact Suite software



**01993:** Hardware interface for Well-contact Plus touch screens. It is necessary touch screen configuration software

IN/OUT devices



**01514:** Interface with 2 input or output programmable channels for LEDs, KNX standard, dimensions: 39,1x40x12,3 mm



**01515.1:** Interface with 4 input or output programmable channels for LEDs, KNX standard, dimensions: 46x46x11,7 mm



**01510:** 4-channel digital input device, programmable for NO, NC and 120-230 V-contacts, KNX standard, 2 x 17,5 mm modules



**01522.1:** 4 IN/OUT, 4 NO 16 A 250 V- programmable relay output with lighting control and store with slats orientation, push button for local control, 4 programmable digit inputs for contacts without potential, KNX standard, 4 x 17,5 mm modules

Actuators



**01523.1:** 4 NO 16 A 250 V- relay outputs for lighting control, store with slats orientation, push buttons for local control, KNX standard, 4 x 17,5 mm modules



**01521.1:** Actuator with 12 NO 10 A 250 V- 50/60 Hz relay outputs for fluorescent lamps, KNX standard, 12 x 17,5 mm modules



**01525:** Actuator for 8 roller shutters, 6 A 230 V- 50/60 Hz relay outputs, KNX standard, 8 x 17,5 mm modules



**01535:** Solenoid valve actuator, 6 230 V- 0,5 A outputs, local control buttons, KNX standard, 4x17,5 mm modules



**01536:** Actuator, 4 0-10 V or (0)4-20 mA analog-outputs, KNX standard, 4x17,5 mm modules

Dimmers



**01550:** Dimmer with 4 NO relay outputs 16 A 250 V-, 4 outputs 0/1-10 V, push buttons for local control, KNX standard, 8 x 17,5 mm module



**01538:** Dimmer 120-240 V- 50/60 Hz, phase cut, 2 outputs for incandescent lamps 40-300 W 240 V-, 20-150 W 120 V-, electronic transformers 40-200 VA, CFL lamps 10-200 W, LED lamps 10-200 W, push buttons for local control, KNX standard, protection fuse, 4 x 17,5 mm modules

Supervising

Interfaces and gateway

						 
<b>01547.1</b> IP interface, KNX, 2 x 17,5 mm modules	<b>01548</b> IP KNX Router, KNX Secure standard, 2 x 17,5 mm modules	<b>01542</b> DALI KNX gateway, 1 channel for 64 lamps into 16 groups, 4 x 17,5 mm modules	<b>01544</b> KNX DALI gateway, 8-channel for 16 lamps per channel, 6 x 17,5 mm modules	<b>01540.1</b> USB interface, KNX B-type, 2 x 17,5 mm modules	<b>01545</b> Web server for local and remote control of the KNX system, 8 x 17,5 mm modules	App By-web**

Additional devices







				
<b>01500.2</b> Power supply with Bus 30 Vdc 320 mA output, 30 Vdc auxiliary output, supply voltage 120-240 V~ 50/60 Hz, with decoupling coil, KNX standard, 4 x 17,5 mm modules	<b>01501.2</b> Power supply with Bus 30 Vdc 640 mA output, 30 Vdc auxiliary output, supply voltage 120-240 V~ 50/60 Hz, with decoupling coil, KNX standard, 4 x 17,5 mm modules	<b>01831.1</b> Supply unit 12 Vdc 1250 mA output, 100-240 V~ 50/60 Hz, 1 x 17,5 mm module	<b>01504.2</b> Line coupler, KNX standard, 2 x 17,5 mm modules	<b>16887</b> Safety transformer, 230/12-24 V~ (SELV), 24 VA, 3 x 17,5 mm modules

KNX cables

	<b>01890.E</b> KNX system cable, 2x2x0,8 mm cable, LSZH sheath, CPR Eca class, suitable for I category cables (U0 = 400 V), green - 100 m		<b>01890.C</b> KNX system cable, 2x2x0,8 mm cable, LSZH sheath, CPR Cca s1b d1 a1 class, suitable for I category cables (U0 = 400 V), green - 100 m
--	--	---	--

Control and functions

Eikon Tactil controls

					
<b>21840</b> 4 independently programmable buttons for single controls or scenes, KNX standard, for Eikon Tactil - 2 modules. Depth: 38 mm	<b>21860</b> 6 independently programmable buttons for single controls or scenes, KNX standard, for Eikon Tactil - 3 modules. Depth: 38 mm	<b>21847</b> 8 stickers sheets with symbols and words for customization of standard function for Eikon Tactil controls	<b>21847.1</b> 4 sheets with labels featuring symbols and wording for external/internal hotel room or cabin functions for Eikon Tactil controls	<b>21847.2</b> 4 stickers sheets with symbols and words for customization of standard function for Eikon Tactil controls	<b>▲ 21847.P</b> Sheet with stickers with symbols and words for customization of function for Eikon Tactil controls

\*\* App available for iOS and Android operating system, downloadable from Apple and Google Play stores.

Control and functions

Eikon Exé Flat controls

	
<b>01580.AX</b> 4-button, KNX standard, visible in darkness with RGB LED brightness adjustment - 2 modules. Depth: 21,5 mm	<b>01585.AX</b> 6-button, KNX standard, visible in darkness with RGB LED brightness adjustment - 3 modules. Depth: 21,5 mm

Interchangeable half-buttons for Eikon Exé Flat controls - 1 module

					
<b>22751.01</b> No symbol, white	<b>22751.03</b> No symbol, grey	<b>22751.11</b> No symbol, nickel	<b>22751.12</b> No symbol, bronze	<b>22751.82</b> No symbol, gold	<b>22751.88</b> No symbol, satin gold
					
<b>22751.0.01</b> No symbol, customisable <sup>2</sup> , white	<b>22751.0.03</b> No symbol, customisable <sup>2</sup> , grey	<b>22751.0.11</b> No symbol, customisable <sup>2</sup> , nickel	<b>22751.0.12</b> No symbol, customisable <sup>2</sup> , bronze	<b>22751.0.82</b> No symbol, customisable <sup>2</sup> , gold	<b>22751.0.88</b> No symbol, customisable <sup>2</sup> , satin gold
					
<b>22751.1.01</b> ON/OFF, white	<b>22751.1.03</b> ON/OFF, grey	<b>22751.1.11</b> ON/OFF, nickel	<b>22751.1.12</b> ON/OFF, bronze	<b>22751.1.82</b> ON/OFF, gold	<b>22751.1.88</b> ON/OFF, satin gold
					
<b>22751.2.01</b> Arrows, white	<b>22751.2.03</b> Arrows, grey	<b>22751.2.11</b> Arrows, nickel	<b>22751.2.12</b> Arrows, bronze	<b>22751.2.82</b> Arrows, gold	<b>22751.2.88</b> Arrows, satin gold
					
<b>22751.3.01</b> Regulation, white	<b>22751.3.03</b> Regulation, grey	<b>22751.3.11</b> Regulation, nickel	<b>22751.3.12</b> Regulation, bronze	<b>22751.3.82</b> Regulation, gold	<b>22751.3.88</b> Regulation, satin gold

<sup>2</sup> To customise Eikon Exé Flat buttons, please contact the commercial network

EIKON ARKÉ PLANA

Control and functions

Eikon, Arké and Plana controls

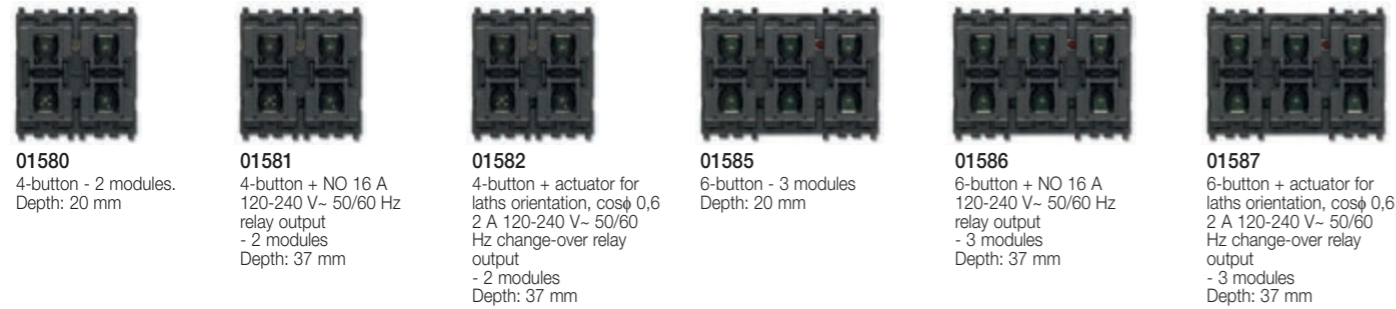

- 01580**  
4-button - 2 modules.  
Depth: 20 mm
- 01581**  
4-button + NO 16 A  
120-240 V~ 50/60 Hz  
relay output  
- 2 modules  
Depth: 37 mm
- 01582**  
4-button + actuator for  
laths orientation, cosφ 0,6  
2 A 120-240 V~ 50/60  
Hz change-over relay  
output  
- 2 modules  
Depth: 37 mm
- 01585**  
6-button - 3 modules  
Depth: 20 mm
- 01586**  
6-button + NO 16 A  
120-240 V~ 50/60 Hz  
relay output  
- 3 modules  
Depth: 37 mm
- 01587**  
6-button + actuator for  
laths orientation, cosφ 0,6  
2 A 120-240 V~ 50/60  
Hz change-over relay  
output  
- 3 modules  
Depth: 37 mm

Interchangeable half buttons for Eikon, Arké and Plana controls - 1-module

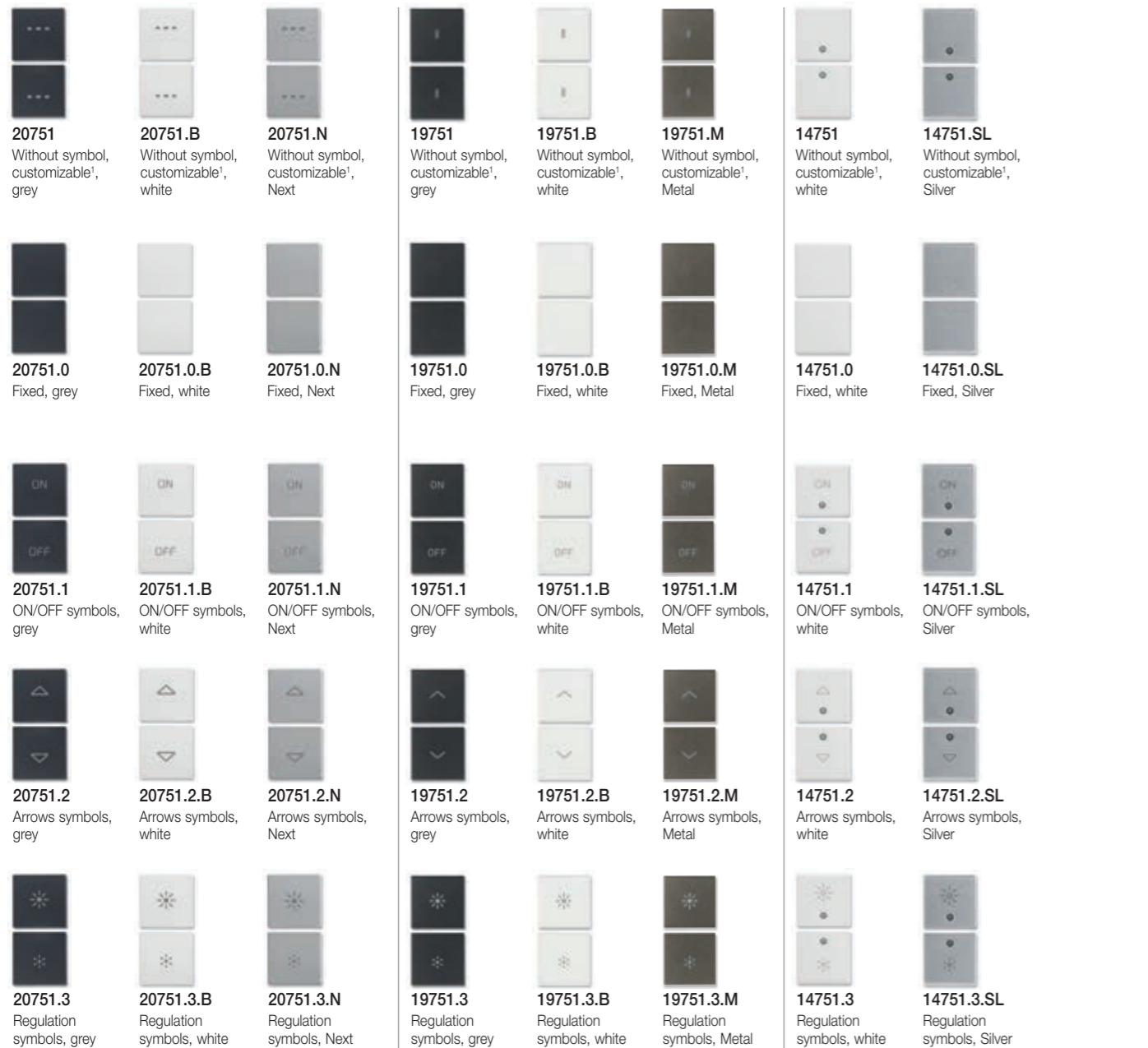

EIKON ARKÉ PLANA

Control and functions

Interchangeable half buttons for Eikon, Arké and Plana controls - 2-module

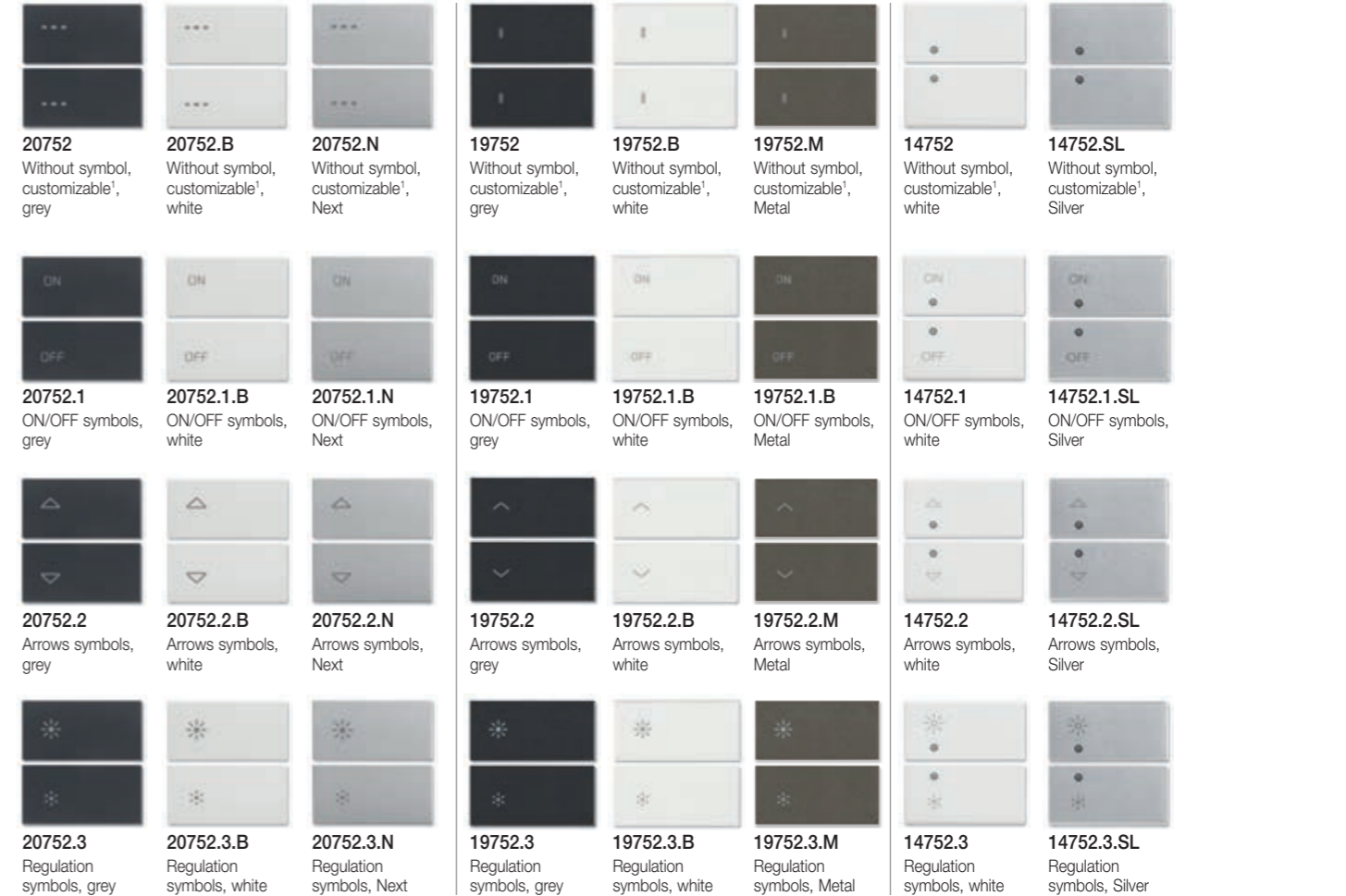

Idea controls

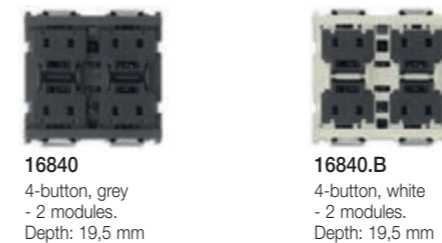

- 16840**  
4-button, grey  
- 2 modules.  
Depth: 19,5 mm
- 16840.B**  
4-button, white  
- 2 modules.  
Depth: 19,5 mm

Four interchangeable half buttons for Idea - 1-module

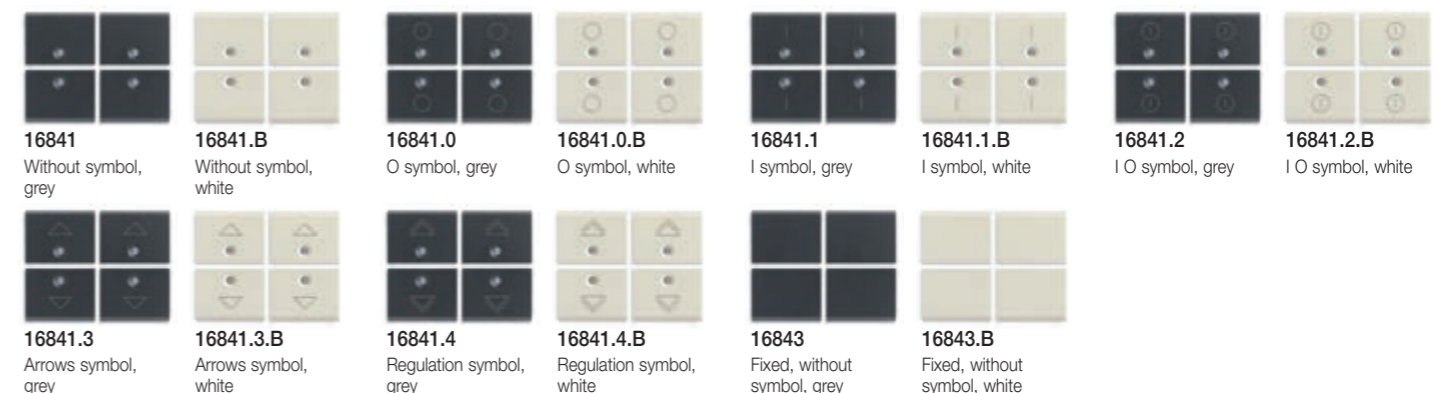

Control and functions

Two interchangeable half buttons for Idea - 2-module



Temperature control

Thermostats



Idea thermostats



Temperature control



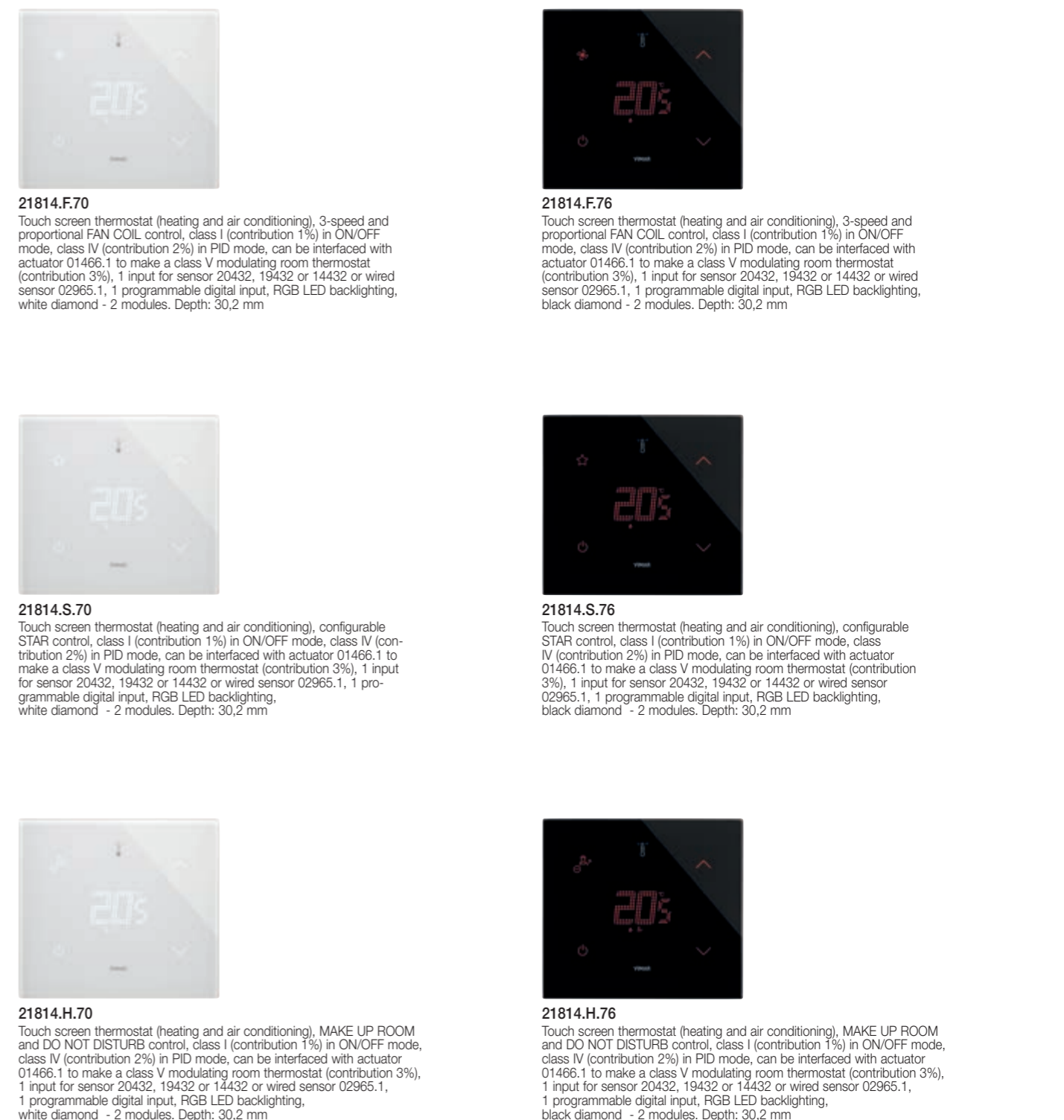





Eikon Tactil thermostats





Temperature control

Temperature sensors

 <b>20432</b> Electronic temperature sensor, grey Depth: 24,4 mm	 <b>20432.B</b> Electronic temperature sensor, white Depth: 24,4 mm	 <b>20432.N</b> Electronic temperature sensor, Next Depth: 24,4 mm	 <b>19432</b> Electronic temperature sensor, grey Depth: 24,4 mm	 <b>19432.B</b> Electronic temperature sensor, white Depth: 24,4 mm	 <b>19432.M</b> Electronic temperature sensor, Metal Depth: 24,4 mm	 <b>14432</b> Electronic temperature sensor, white Depth: 23,4 mm	 <b>14432.SL</b> Electronic temperature sensor, Silver Depth: 23,4 mm
---	---	--	--	---	---	---	---



**02965.1**  
Wired temperature sensor, NTC 10 kΩ, cable length 3 m

Detectors

 <b>20850</b> Passive infrared motion detector, KNX standard, grey - 2 modules. Depth: 26,5 mm	 <b>20850.B</b> Passive infrared motion detector, KNX standard, white - 2 modules. Depth: 26,5 mm	 <b>19850</b> Passive infrared motion detector, KNX standard, grey - 2 modules. Depth: 19,7 mm	 <b>19850.B</b> Passive infrared motion detector, KNX standard, white - 2 modules. Depth: 19,7 mm	 <b>16850</b> Passive infrared motion detector, KNX standard, grey - 2 modules. Depth: 19,5 mm	 <b>16850.B</b> Passive infrared motion detector, KNX standard, white - 2 modules. Depth: 19,5 mm	 <b>14850</b> Passive infrared motion detector, KNX standard, white - 2 modules. Depth: 19 mm	 <b>14850.SL</b> Passive infrared motion detector, KNX standard, Silver - 2 modules. Depth: 19 mm
 <b>20850.N</b> Passive infrared motion detector, KNX standard, Next - 2 modules. Depth: 26,5 mm	 <b>19850.M</b> Passive infrared motion detector, KNX standard, Metal - 2 modules. Depth: 19,7 mm						

Temperature control

Accessories





 <b>00802.14</b> Orientable support, grey - 2 modules	 <b>00802</b> Orientable support, white - 2 modules	 <b>00802.20</b> Orientable support, Silver - 2 modules	 <b>00802.14</b> Orientable support, grey - 2 modules	 <b>00802</b> Orientable support, white - 2 modules	 <b>00802</b> Orientable support, white - 2 modules	 <b>00802.20</b> Orientable support, Silver - 2 modules
 <b>00805.14</b> Adaptor for orientable support flush mounting, grey - 2 modules. Depth: 36,5 mm	 <b>00805</b> Adaptor for orientable support flush mounting, white - 2 modules. Depth: 36,5 mm	 <b>00805.20</b> Adaptor for orientable support flush mounting, Silver - 2 modules. Depth: 36,5 mm	 <b>00805.14</b> Adaptor for orientable support flush mounting, grey - 2 modules. Depth: 36,5 mm	 <b>00805</b> Adaptor for orientable support flush mounting, white - 2 modules. Depth: 36,5 mm	 <b>00805</b> Adaptor for orientable support flush mounting, white - 2 modules. Depth: 36,5 mm	 <b>00805.20</b> Adaptor for orientable support flush mounting, Silver - 2 modules. Depth: 36,5 mm
 <b>00800.14</b> Frame for orientable support surface mounting, grey	 <b>00800</b> Frame for orientable support surface mounting, white	 <b>00800.20</b> Frame for orientable support surface mounting, Silver	 <b>00800.14</b> Frame for orientable support surface mounting, grey	 <b>00800</b> Frame for orientable support surface mounting, white	 <b>00800</b> Frame for orientable support surface mounting, white	 <b>00800.20</b> Frame for orientable support surface mounting, Silver

Weather station



**01546**  
Weather station, KNX standard, power supply 12-32 Vdc or 12-24 Vac

Presence and brightness sensors

 <b>01527</b> IR presence detector, 360° motion range, ON/OFF and adjustment of lighting, heating, air conditioning, ventilation, 1-1000 Lux adjustable brightness range, KNX standard, for ceiling installation. Dimensions: 80x80x45 mm	 <b>01527.S</b> Adapter for 01527 detector ceiling installation	 <b>01529.1</b> IR presence detector, 360° motion range, for ON/OFF lighting, 1-1000 Lux adjustable brightness range, KNX standard, for ceiling installation. Dimensions: 91x91x45 mm	 <b>01529.1.S</b> Adapter for 01529.1 detector ceiling installation	 <b>01530</b> Light sensor for dimmer 01528, KNX standard, ceiling installation. Dimensions: 52,3x54,3x19,3 mm
--	--	--	--	---

Access control

Eikon Tactil: transponder card readers for outdoor of the room

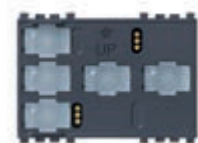

**21457**  
Eikon Tactil touch transponder card reader, KNX standard, 2 relay outputs NO 4 A 24 V~, 2 inputs, 12-24V~ 50/60 Hz and 12-24 Vdc (SELV) - 3 modules. Supplied without transponder card. Depth: 36,5 mm



**21666.70**  
Electronic plate for 21457, white diamond - 3 modules



**21666.71**  
Electronic plate for 21457, aqua - 3 modules



**21666.73**  
Electronic plate for 21457, pearl grey - 3 modules



**21666.76**  
Electronic plate for 21457, black diamond - 3 modules

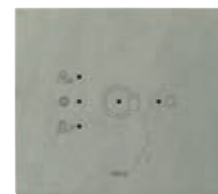

**21666.53**  
Electronic plate for 21457, grey quartzite - 3 modules



**21666.31**  
Electronic plate for 21457, italian walnut - 3 modules



**21666.32**  
Electronic plate for 21457, white oak - 3 modules



**21666.33**  
Electronic plate for 21457, wengé - 3 modules



**21666.21**  
Electronic plate for 21457, cream - 3 modules



**21666.22**  
Electronic plate for 21457, tobacco - 3 modules



**21666.41**  
Electronic plate for 21457, glacier ice - 3 modules



**21457.1**  
Eikon Tactil touch transponder card reader, KNX standard, 2 relay outputs NO 4 A 24 V~, 2 inputs, 12-24 V~ 50/60 Hz and 12-24 Vdc (SELV) - 3 modules. Supplied without transponder card. Depth: 36,5 mm



**21666.70.01**  
Electronic plate for 21457.1, white diamond - 3 modules



**21666.71.01**  
Electronic plate for 21457.1, aqua - 3 modules



**21666.76.01**  
Electronic plate for 21457.1, black diamond - 3 modules



**21846**  
8 sheets with adhesive labels with numbers for room numbering to customise Eikon Tactil cover plates

EIKON

ARKÉ

IDEA

PLANA

Access control



**20457**  
Transponder card reader for installation outside rooms, KNX standard, 2 NO 4 A 24 V~ relay outputs, 2 inputs, power supply 12-24 V~ 50/60 Hz and 12-24 Vdc (SELV), grey - 3 modules. Supplied without transponder card. Depth: 37 mm

**20457.TR**  
As above, tropicalized



**20457.B**  
Transponder card reader for installation outside rooms, KNX standard, 2 NO 4 A 24 V~ relay outputs, 2 inputs, power supply 12-24 V~ 50/60 Hz and 12-24 Vdc (SELV), white - 3 modules. Supplied without transponder card. Depth: 37 mm

**20457.TR.B**  
As above, tropicalized



**20457.N**  
Transponder card reader for installation outside rooms, KNX standard, 2 NO 4 A 24 V~ relay outputs, 2 inputs, power supply 12-24 V~ 50/60 Hz and 12-24 Vdc (SELV), Next - 3 modules. Supplied without transponder card. Depth: 37 mm

**20457.TR.N**  
As above, tropicalized



**19457**  
Transponder card reader for installation outside rooms, KNX standard, 2 NO 4 A 24 V~ relay outputs, 2 inputs, power supply 12-24 V~ 50/60 Hz and 12-24 Vdc (SELV), grey - 3 modules. Supplied without transponder card. Depth: 37 mm

**19457.TR**  
As above, tropicalized



**19457.B**  
Transponder card reader for installation outside rooms, KNX standard, 2 NO 4 A 24 V~ relay outputs, 2 inputs, power supply 12-24 V~ 50/60 Hz and 12-24 Vdc (SELV), white - 3 modules. Supplied without transponder card. Depth: 37 mm

**19457.TR.B**  
As above, tropicalized

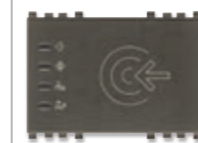

**19457.M**  
Transponder card reader for installation outside rooms, KNX standard, 2 NO 4 A 24 V~ relay outputs, 2 inputs, power supply 12-24 V~ 50/60 Hz and 12-24 Vdc (SELV), Metal - 3 modules. Supplied without transponder card. Depth: 37 mm

**19457.TR.M**  
As above, tropicalized



**16927**  
Transponder card reader for installation outside rooms, KNX standard, 2 NO 4 A 24 V~ relay outputs, 2 inputs, power supply 12-24 V~ 50/60 Hz and 12-24 Vdc (SELV), grey - 3 modules. Supplied without transponder card. Depth: 36,5 mm



**16927.B**  
Transponder card reader for installation outside rooms, KNX standard, 2 NO 4 A 24 V~ relay outputs, 2 inputs, power supply 12-24 V~ 50/60 Hz and 12-24 Vdc (SELV), white - 3 modules. Supplied without transponder card. Depth: 36,5 mm



**14457**  
Transponder card reader for installation outside rooms, KNX standard, 2 NO 4 A 24 V~ relay outputs, 2 inputs, power supply 12-24 V~ 50/60 Hz and 12-24 Vdc (SELV), white - 3 modules. Supplied without transponder card. Depth: 36 mm

**14457.TR**  
As above, tropicalized



**14457.SL**  
Transponder card reader for installation outside rooms, KNX standard, 2 NO 4 A 24 V~ relay outputs, 2 inputs, power supply 12-24 V~ 50/60 Hz and 12-24 Vdc (SELV), Silver - 3 modules. Supplied without transponder card. Depth: 36 mm

**14457.TR.SL**  
As above, tropicalized



**01598**  
Programmable and customizable transponder card

EIKON ARKÉ IDEA PLANA

Access control



**20453**  
Transponder card reader with vertical pocket for installation inside rooms, KNX standard, 2 NO 4 A 24 V~ relay outputs, 2 inputs, power supply 12-24 V~ 50/60 Hz and 12-24 Vdc (SELV), grey - 3 modules. Depth: 37 mm



**19453**  
Transponder card reader with vertical pocket for installation inside rooms, KNX standard, 2 NO 4 A 24 V~ relay outputs, 2 inputs, power supply 12-24 V~ 50/60 Hz and 12-24 Vdc (SELV), grey - 3 modules. Depth: 37 mm



**16923**  
Transponder card reader with vertical pocket for installation inside rooms, KNX standard, 2 NO 4 A 24 V~ relay outputs, 2 inputs, power supply 12-24 V~ 50/60 Hz and 12-24 Vdc (SELV), grey - 3 modules. Depth: 36,5 mm



**14453**  
Transponder card reader with vertical pocket for installation inside rooms, KNX standard, 2 NO 4 A 24 V~ relay outputs, 2 inputs, power supply 12-24 V~ 50/60 Hz and 12-24 Vdc (SELV), white - 3 modules. Depth: 36,5 mm



**20453.B**  
Transponder card reader with vertical pocket for installation inside rooms, KNX standard, 2 NO 4 A 24 V~ relay outputs, 2 inputs, power supply 12-24 V~ 50/60 Hz and 12-24 Vdc (SELV), white - 3 modules. Depth: 37 mm



**19453.B**  
Transponder card reader with vertical pocket for installation inside rooms, KNX standard, 2 NO 4 A 24 V~ relay outputs, 2 inputs, power supply 12-24 V~ 50/60 Hz and 12-24 Vdc (SELV), white - 3 modules. Depth: 37 mm



**16923.B**  
Transponder card reader with vertical pocket for installation inside rooms, KNX standard, 2 NO 4 A 24 V~ relay outputs, 2 inputs, power supply 12-24 V~ 50/60 Hz and 12-24 Vdc (SELV), white - 3 modules. Depth: 36,5 mm



**14453.SL**  
Transponder card reader with vertical pocket for installation inside rooms, KNX standard, 2 NO 4 A 24 V~ relay outputs, 2 inputs, power supply 12-24 V~ 50/60 Hz and 12-24 Vdc (SELV), Silver - 3 modules. Depth: 36,5 mm



**20453.N**  
Transponder card reader with vertical pocket for installation inside rooms, KNX standard, 2 NO 4 A 24 V~ relay outputs, 2 inputs, power supply 12-24 V~ 50/60 Hz and 12-24 Vdc (SELV), Next - 3 modules. Depth: 37 mm



**19453.M**  
Transponder card reader with vertical pocket for installation inside rooms, KNX standard, 2 NO 4 A 24 V~ relay outputs, 2 inputs, power supply 12-24 V~ 50/60 Hz and 12-24 Vdc (SELV), Metal - 3 modules. Depth: 37 mm

EIKON ARKÉ IDEA PLANA

Access control



**20450**  
Transponder card reader/programmer, in 4-module table mounting box, grey. To complete with Eikon 4-module cover plate. Dimensions: 148,6x79x9x88,8 mm



**19450**  
Transponder card reader/programmer, in 4-module table mounting box, grey. To complete with Arké 4-module cover plate. Dimensions: 148,6x82,6x9x90,3 mm



**16920**  
Transponder card reader/programmer, in 3-module table mounting box, grey. To complete with Idea Classica 3-module cover plate. Dimensions: 121,6x81,6x9x111 mm

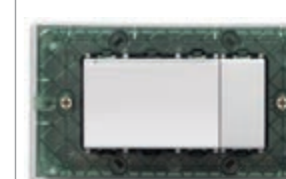

**14450**  
Transponder card reader/programmer, in 4-module table mounting box, white. To complete with Plana 4-module cover plate. Dimensions: 142,5x78,4x9x89,2 mm



**20450.B**  
Transponder card reader/programmer, in 4-module table mounting box, white. To complete with Eikon 4-module cover plate. Dimensions: 148,6x79x9x88,8 mm



**19450.B**  
Transponder card reader/programmer, in 4-module table mounting box, white. To complete with Arké 4-module cover plate. Dimensions: 148,6x82,6x9x90,3 mm



**16920.B**  
Transponder card reader/programmer, in 3-module table mounting box, white. To complete with Idea Classica 3-module cover plate. Dimensions: 121,6x81,6x9x111 mm

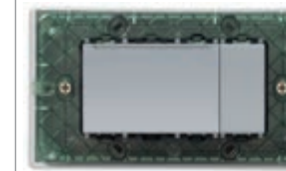

**Δ 14450.SL**  
Transponder card reader/programmer, in 4-module table mounting box, Silver. To complete with Plana 4-module cover plate. Dimensions: 142,5x78,4x9x89,2 mm



**Δ 20450.N**  
Transponder card reader/programmer, in 4-module table mounting box, Next. To complete with Eikon 4-module cover plate. Dimensions: 148,6x79x9x88,8 mm

### Customisation of home automation controls

Positions and features (see area in grey)

For the symbols refer to the "Library of standard symbols and wording" for each series

Series	Type	Customisation position	Backlit customisation	Not backlit customisation
EIKON / ARKÉ	1-module half-buttons		<b>YES</b> only in the 10x10 mm area	if the LED programming is "OFF" the whole button area can be customised
	2-module half-buttons		<b>YES</b> only in the 10x10 mm area	if the LED programming is "OFF" the whole button area can be customised
PLANA	1-module half-buttons		<b>NO</b> backlit LED only	in the programming phase the user can decide whether to set the LED to "OFF" or "ON" or different brightness values
	2-module half-buttons		<b>NO</b> backlit LED only	in the programming phase the user can decide whether to set the LED to "OFF" or "ON" or different brightness values
Specifications for customising with wording				
Customisation with wording not included in the "Library of standard symbols and wording", to be backlit have to be composed of max 3 text rows, each rows with max 8 capital letters for Eikon and Arké and small letters for Plana, font height 1,7 mm and style as the library. Depending on the length of the text, the wording is positioned as shown in the figures to the side.		Text on 1 row	Text on 2 rows	Text on 3 rows

Example of customised controls



### Customisation of radiofrequency controls

Positions and features (see area in grey)

For the symbols refer to the "Library of standard symbols and wording" for each series

	Customisation position	Backlit customisation	Not backlit customisation
Pair of 1-module buttons for RF devices		<b>NO</b>	positions 1 and 2
2-module button for RF devices		<b>NO</b>	positions 1 and 2

### Eikon standard symbols and wordings (♦ symbols already on product catalogue)

### Arké standard symbols and wordings (♦ symbols already on product catalogue)



Index

---

General introduction

Smart products

View Wireless

By-me Plus

Well-contact Plus

**Call-way and antibacterial solutions**

## Call-way and antibacterial solutions

Introduction	186
System architecture	190
Typical systems	196
System devices	202
Devices	204
Cover plates	210

## Call-way and antibacterial solutions: emergency call system and devices for healthcare facilities.

From small clinics to more complex healthcare facilities, it is essential for call devices to always ensure timely intervention and comprehensive assistance. Developed to comply with standard VDE0834-1-2, the Call-way call system is enhanced with Arké and Plana devices in the Antibacterial version to blend in perfectly with solutions that reassure the patients and make the medical staff's work easier.



 **ANTIBACTERIAL**

Many **solutions** to support safely **patient** and **medical staff**.

**BACTERIA REDUCTION.**

To work safely in healthcare facilities, Arké and Plana dispose of cover plates and devices with silver ion antibacterial treatment. This particular process contributes the reduction of germs and bacteria growth to over 90% in 24 hours.

REDUCTION OF  
**90%**  
OF GROWTH  
OF BACTERIA

**ANTIBACTERIAL**



**HEALTH SERVICE.**

Emergency call push buttons for medical staff taking immediate action by reassuring the patient. Signalling units indicate the presence of the staff in the patient's room and if other emergency calls is coming in order to guarantee a total supervision.



**EFFECTIVE COMMUNICATION.**

The communication and display modules manage the emergency calls in an efficient way because the signalling is clear and intuitive, assuring the medical staff operating.



**TOTAL SAFETY FOR PATIENT.**

The call keypad, installed in the bedroom, enables patient to call the medical staff and the lighting switching on/off. The antibacterial treatment and the anti-strangulation function, it is designed for the safety of the person.



**ALL UNDER CONTROL.**

The landing monitor, installed in the wards of the structure, displays the events of the system like calls, staff presence, failures, alarms and service messages.





**System architecture.**

The new Call-way system complies with the standard **VDE0834-1-2** and, within the framework of existing receptive structures, it enables creating management and supervision systems for calls and communications by patients and/or medical and paramedical staff to the switchboard, other rooms or wards, and outside the hospital.

In recent years, the emerging concept of the high-tech hospital and the proliferation of nursing homes and care facilities for the elderly and/or physically challenged has led the market to develop solutions that guarantee increasingly high standards of service and organisation to meet all types of requirement.

The result is Call-way which, in addition to considerably improving organisation in hospitals, private clinics and care facilities, also increases the level of service and safety for patients and optimises the efficiency and effectiveness of the health care professionals working there.

The devices in the Call-way system, developed on Bus technology, offer solutions that enable the highest level of efficiency, responding perfectly to all installation requirements and the constraints imposed by the different facilities such as hospitals, clinics, nursing homes and care facilities in general.

The cables comply the CPR Directive, from E to B2 class.

**Technical specifications.**

What distinguishes the Call-way system is its ease of installation and programming, along with the clarity and flexibility of its use; these devices enable two distinct operating modes:

- **VDE-0834 with PC/Display for Corridor**  
The system is operated by the ADL-EF and is compliant with the VDE0834 -1-2 standard on signalling systems in healthcare facilities. The PC/DC is configured for managing: logs, statistics, ward consolidations and voice calls via the Phone coupler (AT).

- **VDE-0834 without PC**  
The system is still managed by the ADL-EF and is compliant with VDE0834 -1-2. Interfacing is guaranteed with DECT/ pager systems and voice calls to the wards but accessory functions are not handled such as logs, statistics and ward consolidations.

**Methods that invalidate VDE0834-1-2**

- **Off-Line**  
Method to ensure a minimum level of service in the event of failure of an ADL-EF in the network. In the event of failure the secondary backbone will continue to operate and the supervision and corridor display will signal the malfunctioning with dedicated signals.

- **On-line**

This is equivalent to the old way where there is a personal computer that centralizes all the information shown on the display (modules and terminals) in order to supervise the entire system, save events (calls, room number, etc.), manage call priority and voice communication between rooms, between wards and to external devices (fixed or cordless phones, pagers, etc.), diagnostic call management (via clean contact from medical equipment to the display modules or communications terminals).

The display modules, combined with devices called voice modules, will constitute the communication terminals; in addition to displaying the type and characteristics of the calls, the terminal will then not only enable hands-free two-way communication with another terminal but also transmission of a music channel connected to an external source and, if there is a telephone coupler, also interfacing with pagers, switchboards, etc., in order to broadcast announcements and/or talk using the regular phone.

A call by a patient can be made with a special "mini keypad" or a ceiling pull; for this purpose the Call-way system range includes three buttons with an indicator light that match the Plana series and enable having a suitable user interface that is ergonomic, non-invasive on the wall and above all coordinated with all the other components of the traditional electrical system.

The functions/services that the Call-way system is able to offer can be subdivided as follows:

**Services for patients.**

Each patient will be able to make a distress call with a simple manual operation on the mini keypad that is connected to the call button on the bed head.

On activating the call, with either the mini keypad or the button, the caller bed red light will come on (brighter than when on stand-by) which will give the patient the perception and the reassurance of the call being made.

If the room terminal has a voice module, the patient will be able to communicate with nurses and/or physicians via the room terminal (after the medical personnel have started the communication).

The terminal can also be used to receive and adjust the volume of an external sound source (music channel or otherwise); in the case of a service call, an internal relay will automatically switch over the device which will give priority to this call.

From the room's bathroom it will also be possible, as mentioned above, to make a distress call with the dedicated pull-cord; this button also has a red reassurance light that will come on (brighter than when on stand-by) simultaneously with the call for help.

**Services for medical and paramedical staff.**

Using the Call-way system will enable medical and nursing personnel to respond to calls promptly even from a distance (version with voice communication) improving and optimizing response times considerably.

Via the display you can view all the current events (calls, guests in room, priority levels, places of origin of the calls, system failures) and cancel calls locally once the patient has received the care they requested.

If there is a communication terminal, it will be possible to respond locally to a patient call from any room equipped with a terminal and cancel the call at a distance; if the staff providing care to the patient finds a situation of danger or severity they can make an emergency call to request immediate medical attention.

The voice unit channel is always activated with system control when there is a call to the room (generated by the telephone coupler) or a voice unit conference request.

The manner in which the communication is handled (full-duplex/half-duplex) is determined by the device that initiates the voice unit conference:

- telephone coupler: always full-duplex
- voice: depending on the chosen configuration

The half-duplex communication can take place in two ways:

- **Hands-free**, where the "direction" of the communication is established by the tone of voice; the exchange is made when the voice unit module recognizes a higher sound level of one speaker than the other.
- **Push to talk**, where the communication exchange between the parties is made by pressing the "voice direction command" button of the voice module (push-to-talk, release to listen).

**Dedicated services for the hospital management/organization.**

The Call-way system will enable optimizing human resources, significantly improving the efficiency of the service in the ward.

Each display in the room will be able to instantly show the status of calls, the place of origin and the presence of medical and nursing staff; when the installed device is a communication terminal it will be possible to answer and deal with patient calls at a distance, broadcast room and ward announcements and interface with fixed telephone devices, pagers or cordless phones.

With the aid of a PC, with Call-way installed, it will be possible to save the status of events (calls, presences, processing times of calls, etc.) directly to the file so that it can then be stored and subsequently used in case of need.

**Services for patients.**

The patient makes a call with the mini keypad or cord-operated push button; the communication terminal is activated in the nur-

ses' room and in the room; the red light (from the mini keypad) or white light (from the ceiling pull) turns on in the corridor.

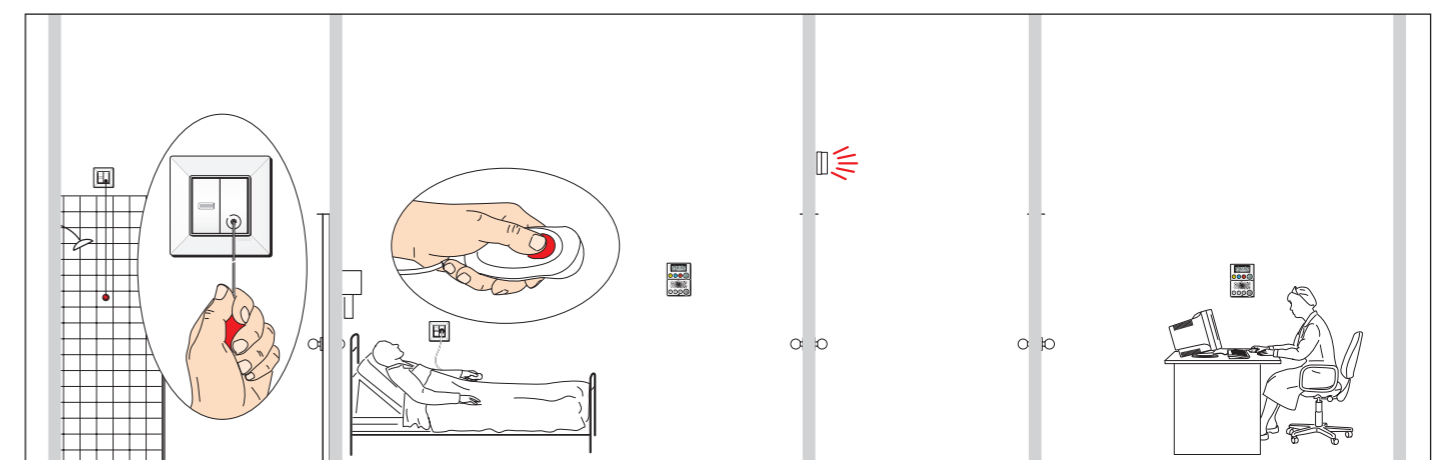

Call-way and antibacterial solutions

Services for medical and paramedical staff.

The nurse comes to the room, cancels the call and shows she needs to remain via the communication terminal; the call is

deactivated in the nurses' room; the red or white light turns off in the corridor and lights up green.

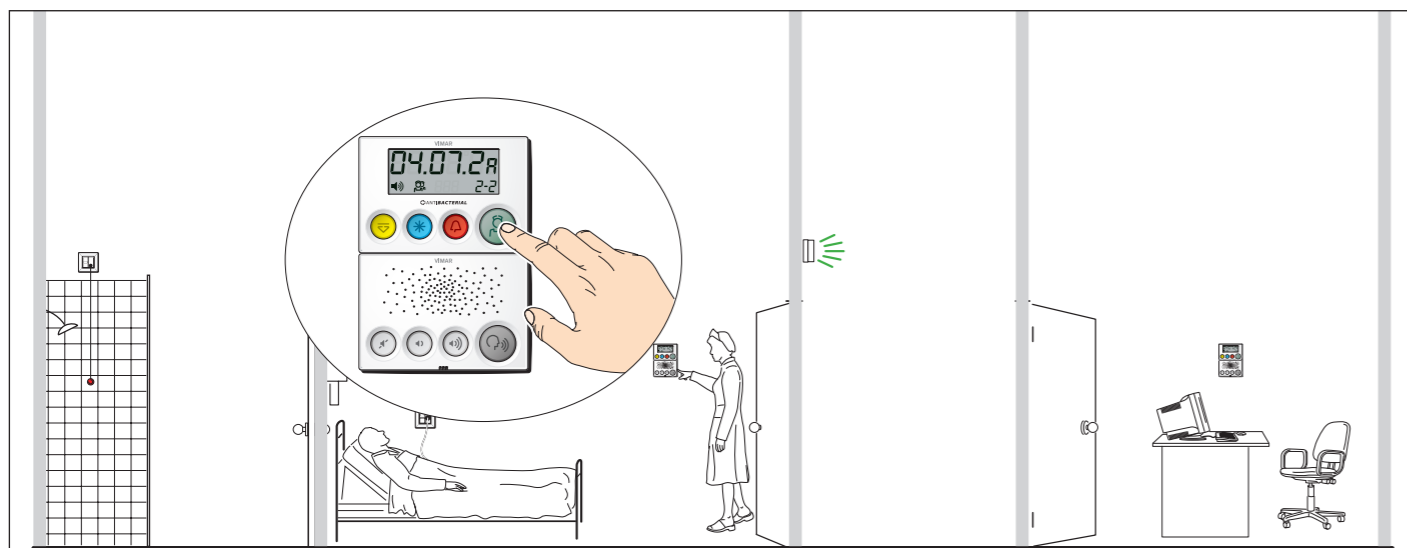

Dedicated services for the hospital management/organization.

The acceptance department and the medical staff within the

facility can monitor calls, operations and personnel in order to maximize resources.

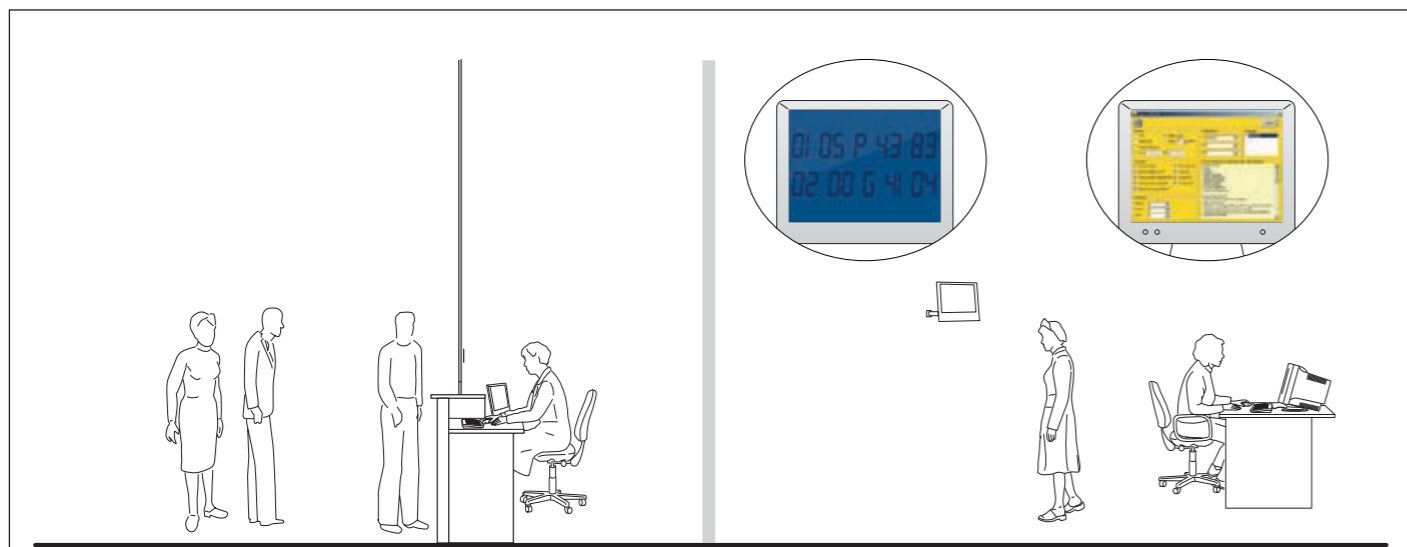

Call-way and antibacterial solutions

System architecture.

The Call-way system uses a Bus as a means of transmission, composed of cables with the following characteristics:

- 2x2,5 mm<sup>2</sup> for connecting the 24 Vdc power supply
- 2x0,22 mm<sup>2</sup> FTP Cat. 5e shielded for data transmission
- 2x0,22 mm<sup>2</sup> FTP Cat. 5e shielded for voice transmission
- 2x0,22 mm<sup>2</sup> FTP Cat. 5e shielded for transmitting announcements/music channel.

As an alternative to the three FTP cables, a single SSTP cable can be used.

Using the Bus to connect devices ensures not only a simplification of the installation, wiring and maintenance operations, but also a high level of immunity from interference.

The main feature of the system architecture is its open loop structure; this allows each device connected to the line to communicate with all the other components in two distinct modes:

• VDE-0834 with PC/Display for Corridor

The system is operated by the ADL-EF and is compliant with the VDE0834 -1-2 standard on signalling systems in health-care facilities. The PC/DC is configured for managing: logs, statistics, ward consolidations and voice calls via the Phone coupler (AT).

• VDE-0834 without PC

The system is still managed by the ADL-EF and is compliant with VDE0834 -1-2. Interfacing is guaranteed with DECT/pager systems and voice calls to the wards but accessory functions are not handled such as logs, statistics and ward consolidations.

The basic element on which the system architecture stands is the line; this is also the starting point for expanding the system up to the maximum possible configuration in terms of devices and shared functions.

Each line can be composed of at most 128 devices, each one with its own physical address (communication terminals, display modules, telephone coupler) and the number of power supply units needed will be determined according to the number of components; each power supply unit delivers an output current of 5 A.

The system is able to manage up to 128 lines connected together by line couplers; all the connected devices communicate with each other over an Ethernet network, exchanging information over the network in accordance with the rules of the communication protocol.

The range of devices comprising the Call-way system is greatly reduced thanks to the considerable flexibility and functionality they offer; just by using the room device (communication terminal or display module), you can control and manage all the inputs/outputs in the room; the default configuration is as follows:

- 3 bed call buttons
- 1 ceiling pull
- 1 ceiling pull cancellation
- 4 landing indicator lamps (call, nurse present, bathroom call and assistance call or diagnostics).

The communication terminal and the display module also allow the following configurations:

- 3 bed calls, 1 bathroom call and 1 bathroom call cancellation
- 2 bed calls, 2 diagnostics calls and 1 bathroom call
- 2 bed calls, 2 diagnostics calls and 1 bathroom call cancellation
- 4 bed calls and 1 bathroom call
- 5 bed calls

The devices are connected serially since, should one of the components malfunction, the proper operation of the other devices is not affected and the services in the other rooms are not impaired.

Installation components.

When creating an installation with the Call-way system, the following components are used:

- Power supply unit
- Line coupler
- Communication terminal
- Display module
- Voice unit module
- Telephone coupler
- Call buttons, mini keypad and landing lamps

Set the system.

It is important, in the phase of system setting, to have a clear idea of which functions are to be implemented according to the type of assistance required; this will obviously depend on the type of the facility where the system is to be installed since, for example, a hospital will have different needs to those of a centre for the physically challenged.

Call-way system devices can be configured, depending on the different needs, in different ways; the types of configuration are the following:

- self-learning, via extremely simple operations carried out manually on the buttons of the display module, in the case of VDE-0834 mode without PC
- using PC software in the case of VDE-0834 mode with PC/Corridor Display.

As regards the actual preparation of the system and therefore laying out the cables and positioning the devices, it will be enough to take into account the following precautions:

- Add up the power inputs of the single devices (that must be no more than 128 per line) such as display modules, communication terminals, line coupler and telephone coupler so as to determine the number of power supplies to install (if the current absorption of the devices in a line is greater than 6.5 A it is necessary to have a second power supply and so on).

When calculating the current absorption it is necessary to take into account the consumption of the button LEDs (bed call, ceiling pull), the mini keypad LEDs and the lamps connected to the display modules and to the communication terminals; each LED has a consumption of 30 mA while for the lamps each module will be able to deliver up to 250 mA.

In the case of wards with a large number of rooms (from 20 to 30 rooms), the total consumption of the lamps and LEDs, which must be added to that of the system devices, is given by the sum of the current absorption of the lamps and LEDs multiplied by 0.2 (coefficient taking into account the fact that it is never possible for all the lamps and LEDs in a system to switch on simultaneously).

Example.

In a ward of 20 rooms, each room is equipped with a communication terminal which is connected to a bed call button and two RJ45 sockets with their mini keypads, a ceiling pull, a call reset button and a landing indicator lamp. The current absorption of the room devices will be equal to:

- Communication terminal current absorption 70 mA;
- Landing lamp output current absorption max 250 mA;
- Push buttons LED current absorption 1 x 30 mA (30 mA).
- Mini keypads LED current absorption 2x 30 mA (60 mA)

The total consumption of the devices in the ward (20 rooms), equal to 2760 mA (2,76 A), is given by:

- (250 mA + 30 mA + 60 mA) x 20 x 0,2 + 20 x 70 mA.

The power supply 02090.2, which delivers an output current of 6,5 A, is thus easily sufficient to provide power to the entire ward.

- Evaluate accurately, according to the size of the healthcare facility, whether a line can be considered as a floor or whether a line can cover a number of floors or, vice versa, whether the property is so large that covering a floor requires a number of lines (therefore, at the design stage, take account of the characteristics of a line in terms of number of devices and consumption).
- The number of lines forming the system will determine the number of couplers that must be installed (the lines are connected together by line couplers that allow communication between devices belonging to different lines).
- Determine the desired requirements for the voice/announcements functions in order to establish the number and location of the phone couplers intended for managing voice communications, interfacing with PABX switchboards and transmitting the announcements/music channel.  
If, for example, a single voice channel is believed sufficient for the entire system, it will be enough to have the telephone coupler on one line; conversely, if you want to implement simultaneous and independent communication between the terminals of a ward and all the others you will need a telephone coupler for each ward.
- The Call-way software lets you easily manage operating profiles/scenarios by time slots or specific days (holidays, etc.) so as to enable centralizing the control desks and all the signalling and voice functions associated with them; this is in order to optimize the presence of personnel without reducing the quality of the service and the level of safety.
- Cables need to be laid depending on the type chosen for system operation (signalling only with display module or signalling and voice with communication terminal).

Call-way system devices, apart from those with DIN pins, can be installed in a V71303 flush mounting 3 module box or in a round 60 mm diameter box. Although display module 02081.AB and communication terminal 02080.AB are wall mounted devices, they need a flush mounting 3 module box or ø 60 mm round box to house the terminals.

**Summary of features and functions.**

The Call-way system is designed to meet the diverse application requirements of public and private health institutions for providing care; as mentioned earlier, it is easy to see how the demands of a nursing home can, for example, be different from those of a hospital or private clinic.

Being able to meet those demands and trying to ensure operational independence, typical of distributed intelligence systems, are the conditions with which the Call-way system has been implemented.

Each ward can be equipped with one or more operating stations (control desks) that directly manage their peripheral units; within the operating station or ward, solutions can be implemented with only the display or with the communication terminal.

Whether to use a personal computer or not uniquely defines the type of operation;

**•VDE-0834 with PC/Display for Corridor**

The system is operated by the ADL-EF and is compliant with the VDE0834 -1-2 standard on signalling systems in healthcare facilities. The PC/DC is configured for managing: logs, statis-

tics, ward consolidations and voice calls via the phone coupler (AT).

**•VDE-0834 without PC**

The system is still managed by the ADL-EF and is compliant with VDE0834 -1-2. Interfacing is guaranteed with DECT/pager systems and voice calls to the wards but accessory functions are not handled such as logs, statistics and ward consolidations.

**Methods that invalidate VDE0834-1-2**

**•Off-Line**

Method to ensure a minimum level of service in the event of failure of an ADL-EF in the network. In the event of failure the secondary backbone will continue to operate and the supervision and corridor display will signal the malfunctioning with dedicated signals.

**•On-line**

This is equivalent to the old way where there is a personal computer that centralizes all the information shown on the display (modules and terminals) in order to supervise the entire system, save events (calls, room number, etc.), manage call priority and voice communication between rooms, between wards and to external devices (fixed or cordless phones, pagers, etc.), diagnostic call management (via clean contact from medical equipment to the display modules or communications terminals).

In the case of on-line operation it becomes necessary to use a line coupler upstream of the backbone (main line from which are derived all the other lines).

Note that, in any case, passing from one system mode to the other does not require replacing any existing components, but only integrating them with additional devices.

Using Bus technology is particularly advantageous especially in economic terms; due to the ease of installation and a significant reduction in the number of conductors, it is possible to dramatically reduce wiring and system configuration times

Equally important is the time for system maintenance; in the event of malfunctioning, internal self-diagnosis recognizes the nature of the fault, identifying the affected device that can be replaced very practically and fast while avoiding unwanted system shutdowns and prolonged disruptions in the room.

**Interoperability with external systems.**

The Call-way system can easily communicate with paging systems (via the ESPA 4.4.4 protocol) and telephone equipment or PABX switchboards.

This type of application enables call transmission even in places where normally there are no specific terminals (for communication or display modules) and allows the medical and paramedical staff to be reached by messages or calls from patient rooms.

If fixed telephone equipment or DECT portable phones are available, healthcare professionals will be able to make direct communication with the room from where the call is made and talk with those present (patients or other health care personnel already in the room) or send messages of a general nature (announcements or warnings) to all the rooms where there are communication terminals.

The above applications depend on the type of device installed in the room:

- with the display module 02081.AB it will be possible to interface the system with pagers;
- with the communication terminal 02080.AB or by adding the voice unit module 02082.AB to the display module 02081.AB, the system can be interfaced with pagers, fixed and cordless

phones; in addition, when interfacing with phones, calls may be transmitted by means of special audio messages (wave files) from the supervisory PC.

**CONFIGURATION AND SUPERVISION.**

The system configuration procedures are very simple and intuitive and they occur in two different ways depending on whether you want to use a PC or not.

Manual configuration is done with the buttons on the front of the display module or the communication terminal with which you are going to set:

- the ward number;
- the room number;
- the function of the device (ie, if the display module functions as a room unit or control desk).
- backward compatibility (should it be necessary to place the device in an existing room with legacy devices).

Each of these operations will be displayed and confirmed or modified with the front buttons of the display module or communication terminal.

Configuration via PC takes place using dedicated software, downloadable free of charge from the VIMAR website, and after

manual configuration in the ward and room of the display modules or communication terminals. The software allows not only adding but also self-acknowledging modules so as to simplify system configuration.

In addition, you can view all calls in progress, the presence of health personnel, the records of all events, the assignment of calls to staff according to the priorities assigned, interfacing with external devices (telephones, pagers, etc.), and the creation of ward association profiles (common recipients of a call).

The software is able to manage the connection between multiple PCs via LAN; each PC can be connected to one or more line couplers 02094 to each of which one or more room devices can be connected according to the requirements and the type of system.

The user interface for all the available menus is graphical and in each window there are fields for entering data; thanks to its network of service providers, Vimar offers a system configuration and start-up service.

The software's user manual, in pdf format, is freely available on [www.vimar.com](http://www.vimar.com); the table below lists the main configuration elements of the Call-way system according to the required types of management and supervision.

	Menu	Function
<b>System configuration</b>	Call parameter configuration	This is used to set the ways in which calls are made (time for passing from one priority to another, call resetting, repeating call audible warning according to a settable time). This menu lets you send not only calls but also the presence of health personnel to the device display, set the audible warning for the start of voice communication, set the destination of a call to the phone coupler and set the serial port if needed.
	Log	This lets you distinguish between events that need to be stored in memory from those that need to be excluded.
	Ward merging profiles	This lets you direct all the calls of one or more wards to another ward where staff are able to assist; this type of function is useful in time slots when staff are fewer (at night) or on particular days of the year (holidays, etc.).
	ESPA settings (for communication with external devices)	The ESPA protocol is one of the most popular standards and allows the Call-way system to interface with other systems and carry out a mutual exchange of information (typical use in paging systems).
<b>Technical Setup</b>	Module/layout configuration	This lets you add, delete or configure not only each device on the Bus, but also every room, bed or bathroom in the building. There are two different viewing methods: layout (viewing wards, rooms, beds and bathrooms) or modules (viewing devices).
<b>Device configuration</b>	Setting device parameters	Sets all those general parameters that regulate the operating mode of each of the devices in the system.
	Technical Setup	Sets the information that appears on the display and the call parameters.
	Telephone coupler technical setup	Sets the specific operating parameters of the phone coupler
	Call configuration (priority, etc.)	Lets you manage call "traffic" according to priority timing and levels of urgency that can be set according to the different needs of the facility.
	Call destination configuration	The call destinations are identified with the devices able to inform the healthcare personnel of the status of the calls and presences of the entire system such as displays, pagers, phones, etc.
	Users Groups/Security	The management software lets you take targeted action on the running of the program and inhibit or allow the use of certain features depending on the user that is using it.
<b>Configuration</b>	Reports	Displays a report (in table form) relating to the events recorded by the system.
	Configuration file	Used to access a configuration file containing some system settings that can be useful to access directly rather than through the database.
	Bus-on-lan	Used to set the parameters for communication between PC and ADL-EF and choose the look and feel of the program and the operating mode.

Call-way and antibacterial solutions

Typical system: call signalling using the 8 input/8 output card 02096.

The figure shows an example of a floor plan showing the system's arrangement in a health care facility that needs to have a call system (signalling only) to display:

- the call, type of call, and its origin (room number, bed, etc.);
- the presence in the room of the healthcare personnel following up on the call;
- calls that could come from other rooms.

The operating mode is VDE-0834, signalling the type of call priority and in which room it is made via the landing lamps and the

combinations of the lights that come on. For more detailed information, such as the bed number, a 02081.AB or a 02097.1 is required.

The Bus will be composed of two different types of cables:

- 1 pair for the power supply (cable 2x2,5 mm<sup>2</sup>);
- 1 pair for data transmission (FTP cat. 5e cable).

**Note.** The 02096 is configured only via dedicated software, the inputs and outputs are independent of each other, the only limit is that they must belong to the same ward. It does not work in on-line mode.



Display to show the events of the Call-way system.

Call button with red reassurance light.

Pull-cord call button with red reassurance light

Typical system: health facility with call signalling in the rooms on the ward using an 8 input/8 output card (art. 02096).

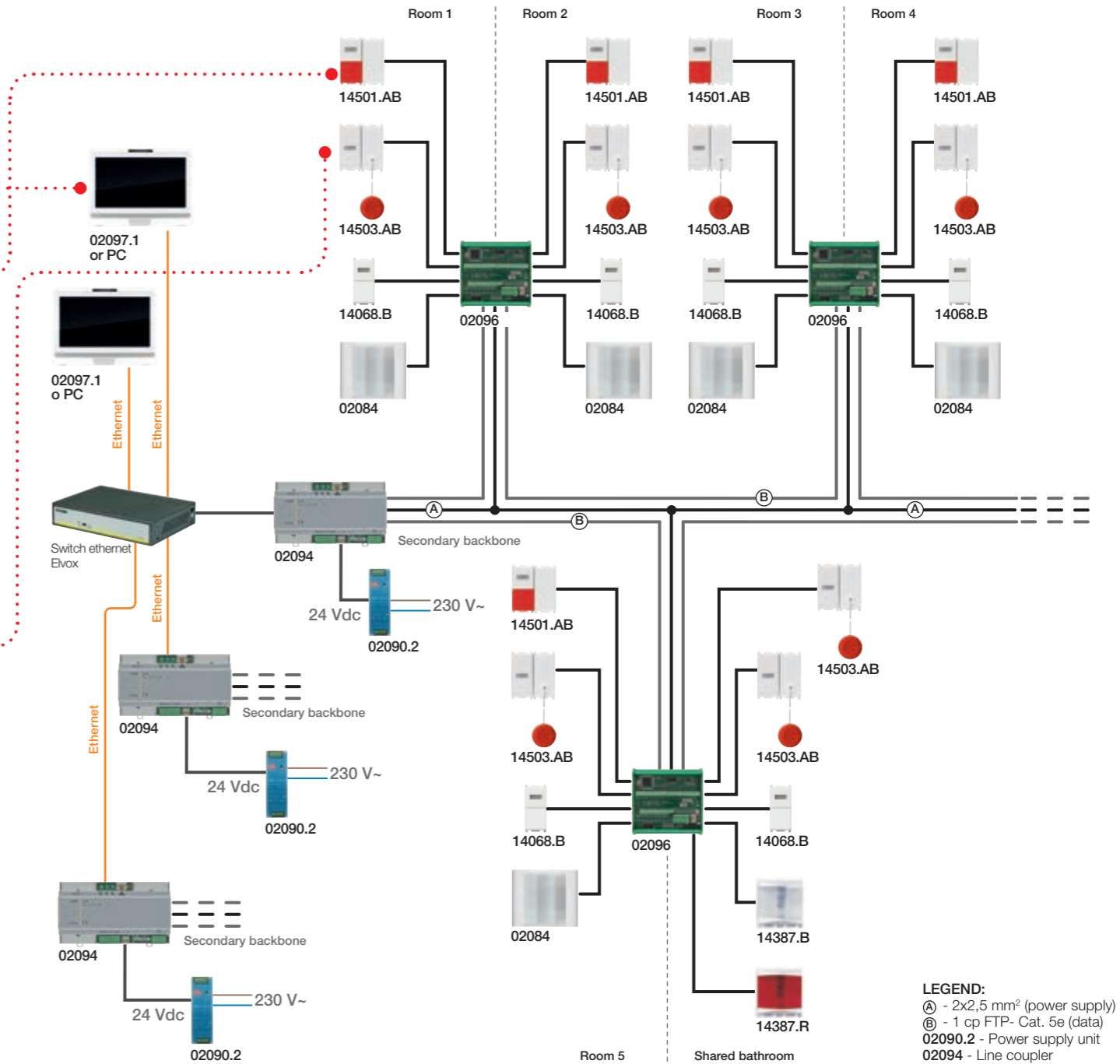

**LEGEND:**  
 (A) - 2x2,5 mm<sup>2</sup> (power supply)  
 (B) - 1 cp FTP- Cat. 5e (data)  
 02090.2 - Power supply unit  
 02094 - Line coupler

**NOTE.** In the case of multi-backbone installation then, with multiple ADL-EF, channel 2 of the ADL-EF (via the Lantronix configurator, at the link: [www.lantronix.com/support/downloads/?p=DEVICEINSTALLER](http://www.lantronix.com/support/downloads/?p=DEVICEINSTALLER)) must be configured as default: with UDP protocol, the same remote port for all the devices, broadcast flag ticked and local host 0.0.0.0. The LED outdoor lamps (art. 02084) are programmable by software.

## Call-way and antibacterial solutions

### Typical system: call signalling using display module 02081.AB.

The figure shows an example of a floor plan showing the system's arrangement in a health care facility that needs to have a call system (signalling only) to display:

- the call, type of call, and its origin (room number, bed, etc.);
- the presence in the room of the healthcare personnel following up on the call;
- calls that could come from other rooms.

The operating mode is VDE-0834, which includes the possibility of distinguishing the call priorities (normal, assistance, emergency). Without the 02097.1 or a PC with dedicated software, the network

does not have an events log or the ability to merge wards automatically. The Bus will be composed of two different types of cables:

- 1 pair for the power supply (cable 2x2,5 mm<sup>2</sup>);
- 1 pair for data transmission (FTP cat. 5e cable)

**Note.**

When setting up it is always wise to have another 2 pairs of FTP cables because if in the future there were a need to expand the system, integrating voice transmission too, it would be enough to add the voice unit module 02082.AB to each display module 02081.AB thus taking action only on the configuration.

**The display module with the addition of the voice unit module basically becomes like a communication terminal 02080.AB.**



Display module for viewing calls.



Mini keypad with 2 light controls and anti-strangulation function

### Typical system: health facility with call signalling in the rooms on the ward using a display module (art. 02081.AB).

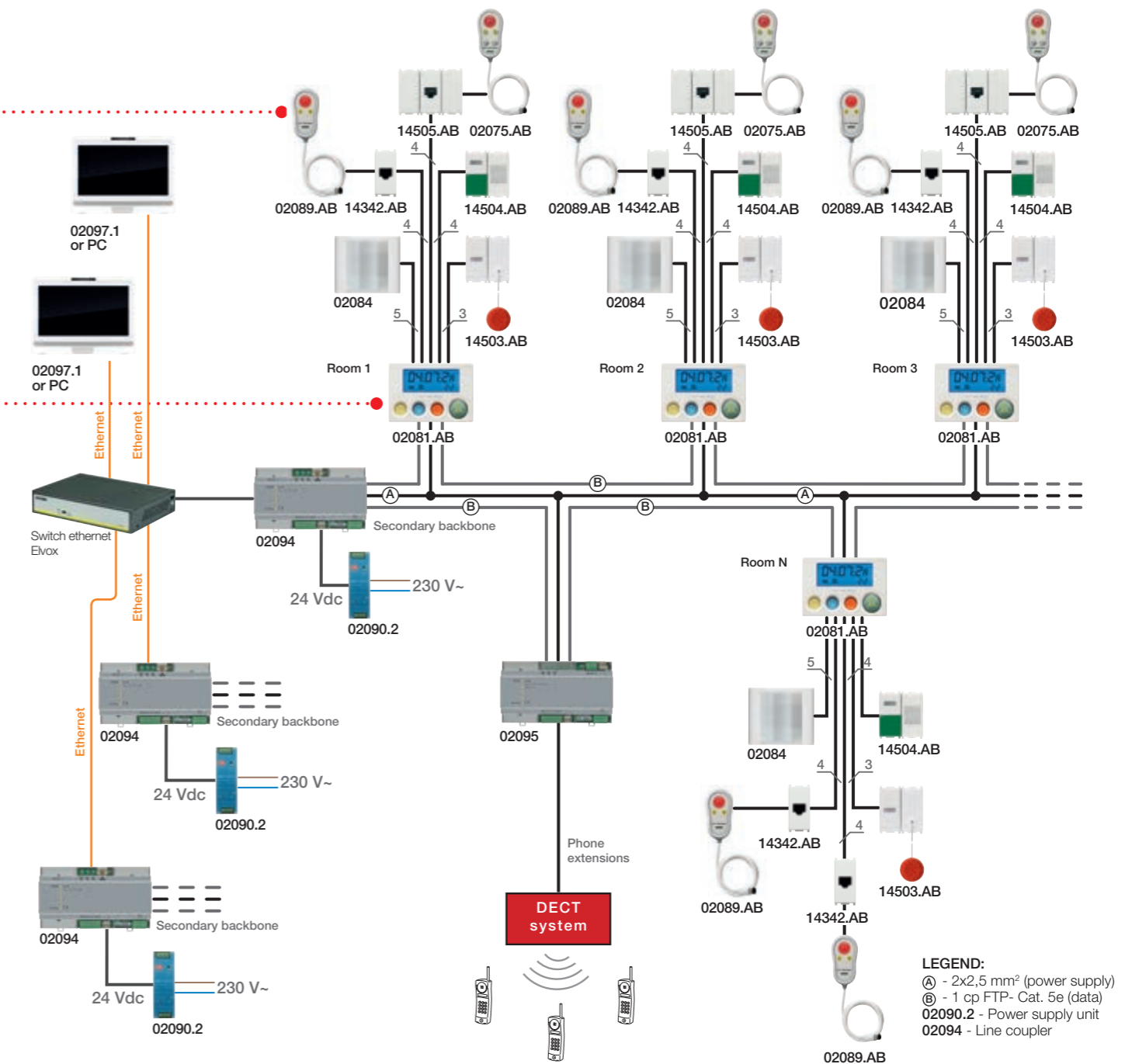

**LEGEND:**  
 Ⓐ - 2x2,5 mm<sup>2</sup> (power supply)  
 Ⓑ - 1 cp FTP- Cat. 5e (data)  
 02090.2 - Power supply unit  
 02094 - Line coupler

**NOTE.**

In the case of multi-backbone installation then, with multiple ADL-EF, channel 2 of the ADL-EF (via the Lantronix configurator, at the link: [www.lantronix.com/support/downloads/?p=DEVICEINSTALLER](http://www.lantronix.com/support/downloads/?p=DEVICEINSTALLER)) must be configured as default: with UDP protocol, the same remote port for all the devices, broadcast flag ticked and local host 0.0.0.0. The LED outdoor lamps (art. 02084) are programmable by software.

## Call-way and antibacterial solutions

### Typical system: voice communication.

In the layout illustrating the system setup in a healthcare facility, there is the need to have a call system that also allows voice communication; the room device that is used is the communication terminal 02080.AB. The device's display will show:

- the call, type of call, and its origin (room number, bed, etc.);
  - the presence in the room of the healthcare personnel following up on the call;
  - calls that could come from other rooms.
- The voice unit part of the device will enable:
- hands-free communication between two parties (patient - nurse, nurse - nurse, nurse - physician) with the two modes "hands free" and "push to talk";
  - transmitting a music channel (which will be promptly discontinued in the event of a call or announcement);

- making room, ward or general announcements (via the telephone coupler connected to the system);
  - communication with fixed telephones (via PABX switchboard) or normal DECT;
- Call-way can be integrated with other systems that support the ESPA 4.4.4 protocol (paggers/DECT).  
The Bus will be composed of two different types of cables:
- 1 pair for the power supply (cable 2x2,5 mm<sup>2</sup>);
  - 3 pairs for data, voice and announcements/music channel transmission respectively (FTP cat. 5e cable).
- Alternatively a single SSTP cable can be used.

**Note.** For only hands-free communication between two communication terminals only the ADL-EF is needed: 02094.



Terminal for communications and displaying calls, formed by display module and voice unit module.

ancellation button with acoustic signal for receiving other calls and green indicator light.

Typical system: health facility with call signalling and voice communication in the rooms on the ward using a terminal 02080.AB.

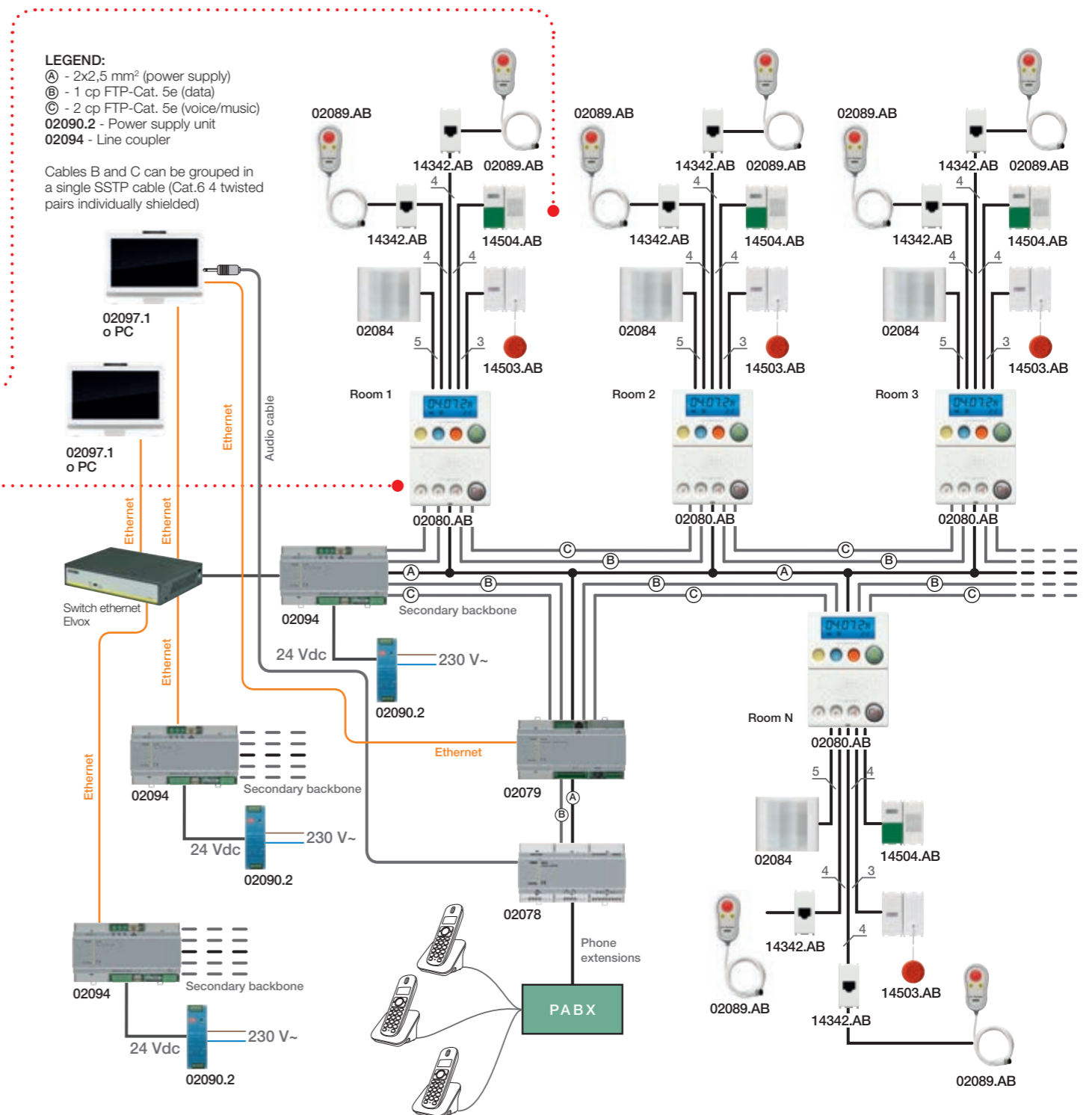

**NOTE.** In the case of multi-backbone installation then, with multiple ADL-EF, channel 2 of the ADL-EF (via the Lantronix configurator, at the link: [www.lantronix.com/support/downloads/?p=DEVICEINSTALLER](http://www.lantronix.com/support/downloads/?p=DEVICEINSTALLER)) must be configured as default: with UDP protocol, the same remote port for all the devices, broadcast flag ticked and local host 0.0.0.0. The LED outdoor lamps (art. 02084) are programmable by software.

System devices

Terminal and modules



**02080.AB**  
Communication and call display terminal, antibacterial material



**02081.AB**  
Display module in single-base, antibacterial material



**02082.AB**  
Phonic module in single-base, antibacterial material

Completion devices



**02075.AB**  
Backlit tail call lead, 2 light controls, 2 auxiliary service controls, anti-strangle function, antibacterial material



**14505.AB**  
Relay module with RJ45 socket outlet for tail call lead with 2 lights + 2 AUX, connection with an 8IN/8OUT module or a Call-way display, 4 24 V NO relay outputs, antibacterial material - 3 modules. Depth: 29,5 mm



**02089.AB**  
Call keypad 2 light controls, anti-strangulation, antibacterial material



**02086\*\***  
Simple mini-keyboard



**02087\*\***  
Simple mini-keyboard with 1 light control



**02088\*\***  
Simple mini-keyboard with 2 light controls



**02085**  
Removable spare terminal, 8 screw terminal

\*\* Call-way spare parts for the first generation of devices

Display



**02097.1**  
Call-way system display, surface mounting



**02098**  
Mounting bracket for display



**02079**  
Ethernet/RS485 interface, 9 x 17,5 mm modules

Landing lamp



**02084**  
LED landing lamp, 4 colours, surface mounting

\* Not to be used in European Countries

▲ New article

△ Available until stocks last

System devices

Accessories and devices for DIN rail (60715 TH35)



**02090.2**  
Power supply unit, 24 Vdc 5 A, 100-240 V~ 50/60 Hz



**02094**  
Line coupler with ethernet and sound system management, 9 x 17,5 mm modules



**02078**  
Phone coupler, 9 x 17,5 mm modules



**02095**  
Serial interface ESPA 4.4.4, 9 x 17,5 mm modules



**02096**  
Card with 8 inputs and 8 outputs, 8 x 17,5 mm modules

Cables



**03061.E**  
Cat. 5e F/UTP cable, shielded, 4-pair, 24 AWG, LSZH-sheath, CPR Eca class, suitable for I category cables (U0 = 400 V), grey - 305 m



**03071.B2**  
Cat. 6 U/UTP cable, unshielded, 4-pair, 23 AWG, LSZH-sheath, CPR B2ca class, blue - 500 m



**03076.E**  
Cat. 6 F/UTP cable, shielded, 4-pair, 23 AWG, LSZH sheath, CPR Eca class, suitable for I category cables (U0 = 400 V), green - 500 m



**03086.B2**  
Cat. 6A F/FTP cable, shielded, 4-pair, 23 AWG, LSZH sheath, CPR B2ca class, blue - 500 m



**03086.E**  
Cat. 6A S/FTP cable, shielded, 4-pair, 23 AWG, LSZH sheath, CPR Eca class, suitable for I category cables (U0 = 400 V), orange - 500 m

Special switches



**14501.AB\***  
Call push button, with red reassurance indicator unit, antibacterial material - 2 modules. Depth: 36 mm



**14502**  
Call push button with DIN 7-contact socket outlets - 2 modules. Depth: 37 mm



**14503.AB\***  
Cord-operated push button with red reassurance indicator unit, antibacterial material - 2 modules. Depth: 36 mm



**14504.AB\***  
Cancel call push button, with acoustic signalling and green indicator unit, antibacterial material - 2 modules. Depth: 36 mm

\* Push button suitable for ABB Cinos system.

Prismatic indicator units (for 14771 and 14777 lamps)



**14387.B**  
230 V~ 3 W max, white diffuser. - 2 modules. Depth: 24 mm



**14387.R**  
230 V~ 3 W max, red diffuser. - 2 modules. Depth: 24 mm



**14387.V**  
230 V~ 3 W max, green diffuser. - 2 modules. Depth: 24 mm

ARKÉ | PLANA

Devices

Control devices with antibacterial material



**19041.AB**  
Blank module, grey.  
Depth: 11 mm



**19041.AB.B**  
Blank module, white.  
Depth: 11 mm



**14041.AB**  
Blank module, white.  
Depth: 10 mm



**19001.AB**  
1P 1-way switch,  
16 AX 250 V~, lightable, grey.  
Depth: 25 mm



**19001.AB.B**  
1P 1-way switch,  
16 AX 250 V~, lightable, white.  
Depth: 25 mm



**14001.AB**  
1P 1-way switch,  
16 AX 250 V~, white.  
Depth: 24 mm



**19015.AB**  
2P 1-way switch,  
16 AX 250 V~, lightable, grey.  
Depth: 25 mm



**19015.AB.B**  
2P 1-way switch,  
16 AX 250 V~, lightable, white.  
Depth: 25 mm



**14015.AB**  
2P 1-way switch,  
16 AX 250 V~, white.  
Depth: 24 mm



**19005.AB**  
1P 2-way switch,  
16 AX 250 V~, lightable, grey.  
Depth: 25 mm



**19005.AB.B**  
1P 2-way switch,  
16 AX 250 V~, lightable, white.  
Depth: 25 mm



**14005.AB**  
1P 2-way switch,  
16 AX 250 V~, white.  
Depth: 24 mm



**19013.AB**  
1P reversing switch,  
16 AX 250 V~, lightable, grey.  
Depth: 25 mm



**19013.AB.B**  
1P reversing switch,  
16 AX 250 V~, lightable, white.  
Depth: 25 mm



**14013.AB**  
1P reversing switch,  
16 AX 250 V~, white.  
Depth: 24 mm



**19008.AB**  
1P NO push button,  
10 A 250 V~, lightable, grey.  
Depth: 26 mm



**19008.AB.B**  
1P NO push button,  
10 A 250 V~, lightable, white.  
Depth: 26 mm



**14008.AB**  
1P NO push button,  
10 A 250 V~, white.  
Depth: 24 mm

ARKÉ | PLANA

Devices

Control devices with antibacterial material



**19022.AB**  
Interchangeable  
2-module button,  
lightable, grey



**19022.AB.B**  
Interchangeable  
2-module button,  
lightable, white



**14022.AB**  
Interchangeable button,  
with lightable ring pilot  
lamp, no symbol  
- 2 modules, white



**19050.AB**  
1P NO 10 A 250 V~  
push button, with  
lightable name-plate,  
grey - 2 modules.  
Depth: 26,2 mm



**19050.AB.B**  
1P NO 10 A 250 V~  
push button, with  
lightable name-plate,  
white - 2 modules.  
Depth: 26,2 mm



**19052.AB**  
1P NO 10 A 250 V~  
cord-operated push  
button, 1,5 m cord,  
grey. Depth: 26 mm



**19052.AB.B**  
1P NO 10 A 250 V~  
cord-operated push  
button, 1,5 m cord,  
white. Depth: 26 mm



**14052.AB**  
1P NO 10 A 250 V~  
cord-operated push  
button, 1,5 m cord,  
white. Depth: 24 mm



**19062.AB**  
2 1P NO 10 A 250 V~  
push buttons,  
interlocked, grey.  
Depth: 29 mm



**19062.AB.B**  
2 1P NO 10 A 250 V~  
push buttons,  
interlocked, white.  
Depth: 29 mm



**19135.AB.1**  
MASTER dimmer,  
universal, grey.  
Depth: 40,5 mm



**19135.AB.1.B**  
MASTER dimmer,  
universal, white.  
Depth: 40,5 mm



**14136.AB.1**  
MASTER dimmer, universal,  
with potentiometer, white.  
Depth: 40,5 mm

Socket outlets with antibacterial material



**19201.AB**  
2P+E 10 A 250 V~  
SICURY socket outlet,  
Italian standard P11,  
grey. Depth: 25,3 mm



**19201.AB.B**  
2P+E 10 A 250 V~  
SICURY socket outlet,  
Italian standard P11,  
white. Depth: 25,3 mm



ARKÉ PLANA

Devices

Socket outlets with antibacterial material

<b>19203.AB</b> Bpresa SICURY 2P+E 16 A 250 V~ socket outlet, Italian standard, P17/11, grey. Depth: 25,3 mm	<b>19203.AB.B</b> Bpresa SICURY 2P+E 16 A 250 V~ socket outlet, Italian standard, P17/11, white. Depth: 25,3 mm	<b>14203.AB</b> Bpresa SICURY 2P+E 16 A 250 V~ socket outlet, Italian standard, P17/11, white. Depth: 24 mm	<b>14203.AB.R</b> Bpresa SICURY 2P+E 16 A 250 V~ socket outlet, Italian standard P17/11, red. For dedicated supply. Depth: 24 mm		
<b>19210.AB</b> SICURY 2P+E 16 A 250 V~ universal socket outlet, grey - 2 modules. Depth: 26 mm	<b>19210.AB.B</b> SICURY 2P+E 16 A 250 V~ universal socket outlet, white - 2 modules. Depth: 26 mm	<b>14210.AB</b> SICURY 2P+E 16 A 250 V~ universal socket outlet, white - 2 modules. Depth: 25 mm	<b>14210.AB.A</b> SICURY 2P+E 16 A 250 V~ universal socket outlet, orange - 2 modules. For dedicated supply. Depth: 25 mm	<b>14210.AB.R</b> SICURY 2P+E 16 A 250 V~ universal socket outlet, red - 2 modules. For dedicated supply. Depth: 25 mm	<b>14210.AB.V</b> SICURY 2P+E 16 A 250 V~ universal socket outlet, green - 2 modules. For dedicated supply. Depth: 25 mm
<b>19208.AB</b> SICURY 2P+E 16 A 250 V~ socket outlet, German standard, grey - 2 modules. Depth: 29 mm	<b>19208.AB.B</b> SICURY 2P+E 16 A 250 V~ socket outlet, German standard, white - 2 modules. Depth: 29 mm	<b>14208.AB</b> SICURY 2P+E 16 A 250 V~ socket outlet, German standard, white - 2 modules. Depth: 28,4 mm			
<b>19212.AB</b> SICURY 2P+E 16 A 250 V~ socket outlet, French standard, grey - 2 modules. Depth: 26 mm	<b>19212.AB.B</b> SICURY 2P+E 16 A 250 V~ socket outlet, French standard, white - 2 modules. Depth: 26 mm	<b>14212.AB</b> SICURY 2P+E 16 A 250 V~ socket outlet, French standard, white - 2 modules. Depth: 25,4 mm			

Match of foreign standard plugs and socket outlets

S10 Italian standard plug	●	●
2P 2,5 A Europlug	●	●
2P+E 16 A 250 V~ German standard plug	●	●
2P+E 16 A 250 V~ German and French standards plug	●	●
2P 16 A 250 V~ German and French standards plug	●	●
2P+E 16 A 250 V~ French standard plug	●	●

● Plug standard matches socket outlet

ARKÉ PLANA

Devices

Socket outlets with antibacterial material

<b>19290.AB</b> Shaver supply unit with 20 VA isolating transformer, 230 V~ 50/60 Hz, 230 V~ and 120 V~, grey - 3 modules. Depth: 42 mm	<b>19290.AB.B</b> Shaver supply unit with 20 VA isolating transformer, 230 V~ 50/60 Hz, 230 V~ and 120 V~, white - 3 modules. Depth: 42 mm	<b>14290.AB</b> Shaver supply unit with 20 VA isolating transformer, 230 V~ 50/60 Hz, 230 V~ and 120 V~, white - 3 modules. Depth: 41 mm
<b>19292.AC.AB</b> 5 V 2,4 A USB power supply unit, USB A+C, 120-240 V~ 50/60 Hz, grey. Depth: 36 mm	<b>19292.AC.AB.B</b> 5 V 2,4 A USB power supply unit, USB A+C, 120-240 V~ 50/60 Hz, white. Depth: 36 mm	
<b>19295.AC.AB</b> 5 V 3 A USB power supply unit, USB A+C for total of 3 A, 120-240 V~ 50/60 Hz, grey - 2 modules. Depth: 29,3 mm	<b>19295.AC.AB.B</b> 5 V 3 A USB power supply unit, USB A+C for total of 3 A, 120-240 V~ 50/60 Hz, white - 2 modules. Depth: 29,3 mm	

Signal reception socket outlets with antibacterial material

<b>19300.01.AB</b> Coaxial TV-RD-SAT 5-2400 MHz socket outlet, direct, 1 dB, grey. Depth: 22,1 mm	<b>19300.01.AB.B</b> Coaxial TV-RD-SAT 5-2400 MHz socket outlet, direct, 1 dB, white. Depth: 22,1 mm	<b>14300.AB.01</b> Coaxial TV-RD-SAT 5-2400 MHz socket outlet, direct, 1 dB, white. Depth: 21,6 mm
<b>19320.AB</b> RJ11 socket, 6-position 4-contact (6/4), grey. Depth: 33,1 mm	<b>19320.AB.B</b> RJ11 socket, 6-position 4-contact (6/4), white. Depth: 33,1 mm	<b>14330.AB</b> 2P 6 A 24 V (SELV) socket for plug 01620, white. Depth: 24 mm
		<b>14320.AB</b> RJ11 socket, 6-position 4-contact (6/4), white. Depth: 32,6 mm

ARKÉ | PLANA

Devices

Signal reception socket outlets with antibacterial material



**19339.11.AB**  
RJ45 socket with Netsafe, Cat. 5e, UTP, grey. Depth: 29,8 mm



**19339.11.AB.B**  
RJ45 socket with Netsafe, Cat. 5e, UTP, white. Depth: 29,8 mm



**19339.13.AB**  
RJ45 socket with Netsafe, Cat. 6, UTP, grey. Depth: 29,8 mm



**19339.13.AB.B**  
RJ45 socket with Netsafe, Cat. 6, UTP, white. Depth: 29,8 mm



**14339.AB.13**  
RJ45 socket with Netsafe, Cat. 6, UTP, white. Depth: 29,3 mm



**14339.AB.14**  
RJ45 socket with Netsafe, Cat. 6, FTP, white. Depth: 29,3 mm



**14342.AB**  
RJ45 socket connector, 8-position, 8-contact (8/8), white. Depth: 32,6 mm

Hotel solutions with antibacterial material



**19097.AB**  
1P NO 10 A 250 V~ push button, for hotel "Do Not Disturb" and "Please Clean" lightable - 2 modules. Depth: 28 mm



**19463.AB**  
Electronic badge switch with vertical pocket, 4 A 250 V~ NO (NON SELV) change-over relay output, 120-230 V~ 50/60 Hz, grey - 2 modules. Supplied without ISO card (badge) Depth: 20,5 mm



**19463.AB.B**  
Electronic badge switch with vertical pocket, 4 A 250 V~ NO (NON SELV) change-over relay output, 120-230 V~ 50/60 Hz, white - 2 modules. Supplied without ISO card (badge) Depth: 20,5 mm

ARKÉ | PLANA

Devices

Hotel solutions with antibacterial material



**19465.AB**  
Electronic badge switch with vertical pocket, 16 A 250 V~ change-over relay output, 230 V~ 50/60 Hz and 24 Vdc (SELV), grey - 3 modules. Supplied without ISO card (badge) Depth: 37 mm



**19465.AB.B**  
Electronic badge switch with vertical pocket, 16 A 250 V~ change-over relay output, 230 V~ 50/60 Hz and 24 Vdc (SELV), white - 3 modules. Supplied without ISO card (badge) Depth: 37 mm

Two interchangeable half-buttons for controls with antibacterial material



**19751.AB**  
No symbol, customisable, grey



**19751.AB.B**  
No symbol, customisable, white



**19751.AB.0**  
Fixed, neutral, grey



**19751.AB.0.B**  
Fixed, neutral, white



**19751.AB.1**  
ON/OFF symbols, grey



**19751.AB.1.B**  
ON/OFF symbols, white



**19751.AB.2**  
Arrows symbol, grey



**19751.AB.2.B**  
Arrows symbol, white



**19751.AB.3**  
Regulation symbol, grey



**19751.AB.3.B**  
Regulation symbol, white



**19751.AB.4**  
I/O volume symbol, grey



**19751.AB.4.B**  
I/O volume symbol, white

ARKÉ PLANA

Cover plates

Technopolymer cover plates with antibacterial material



ARKÉ PLANA

Cover plates

Technopolymer cover plates with antibacterial material







# Energia Positiva. Insieme

